

VACON[®] 100
AC DRIVES

APPLICATION MANUAL

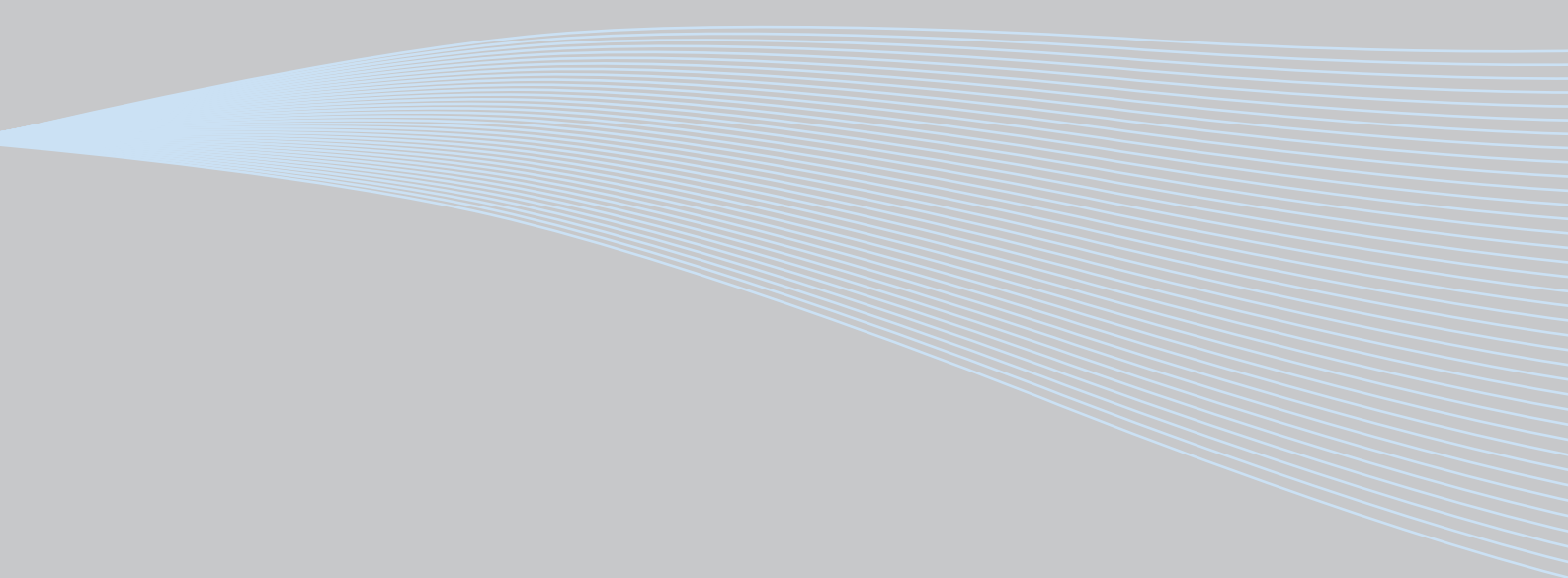

PREFACE

Document ID:	DPD00927F
Date:	30.1.2014
Software version:	FW0072V012

ABOUT THIS MANUAL

This manual is copyright of Vacon Plc. All Rights Reserved.

In this manual, you can read about the functions of the Vacon® AC drive and how to use the drive. The manual has the same structure than the menu of the drive (chapters 1 and 4-8).

Chapter 1, Quick Startup Guide

- How to start the work with the control panel.

Chapter 2, Wizards

- Making a selection of the application configuration.
- Setting up an application quickly.
- The different applications with examples.

Chapter 3, User Interfaces

- The display types and how to use the control panel.
- The PC tool Vacon Live.
- The functions of the fieldbus.

Chapter 4, Monitoring menu

- Data on the monitoring values.

Chapter 5, Parameter menu

- A list of all the parameters of the drive.

Chapter 6, Diagnostics menu

Chapter 7, I/O and Hardware menu

Chapter 8, User settings, favourites and user level menus

Chapter 9, Parameter descriptions

- How to use the parameters.
- Digital and analogue input programming.
- Application-specific functions.

Chapter 10, Fault tracing

- The faults and their causes.
- Resetting the faults.

Chapter 11, Appendix

- Data on the different default values of the applications.

This manual includes a large quantity of parameter tables. These instructions tell you how to read the tables.

Index	Parameter	Min	Max	Unit	Default	ID	Description
							

- | | |
|---|---|
| <p>A. The location of the parameter in the menu, that is, the parameter number.</p> <p>B. The name of the parameter.</p> <p>C. The minimum value of the parameter.</p> <p>D. The maximum value of the parameter.</p> <p>E. The unit of the value of the parameter. The unit shows if it is available.</p> | <p>F. The value that was set in the factory.</p> <p>G. The ID number of the parameter.</p> <p>H. A short description of the values of the parameter and/or its function.</p> <p>I. When the symbol shows, you can find more data about the parameter in Chapter Parameter descriptions.</p> |
|---|---|

NOTE! You can download the English and French product manuals with applicable safety, warning and caution information from www.vacon.com/downloads.

REMARQUE Vous pouvez télécharger les versions anglaise et française des manuels produit contenant l'ensemble des informations de sécurité, avertissements et mises en garde applicables sur le site www.vacon.com/downloads.

FUNCTIONS OF THE VACON® AC DRIVE

- Wizards for startup, PID control, multipump and fire mode to make the commissioning easy.
- The FUNCT button for an easy change between the local and the remote control place. The remote control place can be I/O or fieldbus. You can make a selection of the remote control place with a parameter.
- 8 preset frequencies.
- Motor potentiometer functions.
- A joystick control.
- A jogging function.
- 2 programmable ramp times, 2 supervisions and 3 ranges of prohibited frequencies.
- A forced stop.
- A control page to operate and monitor of the most important values quickly.
- A fieldbus data mapping.
- An automatic reset.
- Different pre-heat modes to prevent condensation problems.
- A maximum output frequency of 320 Hz.
- A Real time clock and timer functions (an optional battery is necessary). It is possible to program 3 time channels to get different functions on the drive.
- An external PID controller is available. You can use it, for example, to control a valve with the I/O of the AC drive.
- A sleep mode function that automatically enables and disables the operation of the drive to save energy.
- A 2-zone PID controller with 2 different feedback signals: minimum and maximum control.
- 2 setpoint sources for the PID control. You can make the selection with a digital input.
- A function for PID setpoint boost.
- A feedforward function to make the response to the process changes better.
- A process value supervision.
- A multipump control.
- A maintenance counter.
- Pump control functions: priming pump control, jockey pump control, pump impeller auto-cleaning, pump input pressure supervision and frost protection function.

TABLE OF CONTENTS

Preface

About this manual	3
Functions of the Vacon® AC drive	5
1 Quick Startup Guide	11
1.1 Control panel and keypad	11
1.2 The displays	11
1.3 First start-up	12
1.4 Description of the applications	14
1.4.1 Standard application	14
1.4.2 Local/Remote application	21
1.4.3 Multi-step speed application	28
1.4.4 PID control application	35
1.4.5 Multi-purpose application	45
1.4.6 Motor potentiometer application	55
2 Wizards	63
2.1 Standard application wizard	63
2.2 Local/Remote application wizard	64
2.3 Multi-step speed application wizard	65
2.4 PID control application wizard	66
2.5 Multi-purpose application wizard	68
2.6 Motor potentiometer application wizard	69
2.7 Multipump wizard	70
2.8 Fire mode wizard	72
3 User interfaces	74
3.1 Navigation on the keypad	74
3.2 Using the graphical display	76
3.2.1 Editing the values	76
3.2.2 Resetting a fault	79
3.2.3 The FUNCT button	79
3.2.4 Copying the parameters	83
3.2.5 Comparing the parameters	85
3.2.6 Help texts	86
3.2.7 Using the Favourites menu	87
3.3 Using the text display	87
3.3.1 Editing the values	88
3.3.2 Resetting a fault	89
3.3.3 The FUNCT button	89
3.4 Menu structure	93
3.4.1 Quick setup	94
3.4.2 Monitor	94
3.5 Vacon Live	96

4	Monitoring menu	97
4.1	Monitor group	97
4.1.1	Multimonitor	97
4.1.2	Trend curve	98
4.1.3	Basic	101
4.1.4	I/O	103
4.1.5	Temperature inputs	103
4.1.6	Extras and advanced	105
4.1.7	Timer functions monitoring	107
4.1.8	PID controller monitoring	108
4.1.9	External PID controller monitoring	109
4.1.10	Multipump monitoring	109
4.1.11	Maintenance counters	110
4.1.12	Fieldbus data monitoring	111
5	Parameters menu	113
5.1	Group 3.1: Motor settings	113
5.2	Group 3.2: Start/stop setup	121
5.3	Group 3.3: References	124
5.4	Group 3.4: Ramps and brakes setup	134
5.5	Group 3.5: I/O configuration	137
5.6	Group 3.6: Fieldbus data mapping	151
5.7	Group 3.7: Prohibit frequencies	153
5.8	Group 3.8: Supervisions	154
5.9	Group 3.9: Protections	155
5.10	Group 3.10: Automatic reset	166
5.11	Group 3.11: Application settings	168
5.12	Group 3.12: Timer functions	169
5.13	Group 3.13: PID controller	172
5.14	Group 3.14: External PID controller	188
5.15	Group 3.15: Multipump	193
5.16	Group 3.16: Maintenance counters	195
5.17	Group 3.17: Fire mode	196
5.18	Group 3.18: Motor preheat parameters	198
5.19	Group 3.20: Mechanical brake	200
5.20	Group 3.21: Pump control	201
6	Diagnostics menu	204
6.1	Active faults	204
6.2	Reset faults	204
6.3	Fault history	204
6.4	Total counters	204
6.5	Trip counters	206
6.6	Software info	207
7	I/O and hardware menu	208
7.1	Basic I/O	208
7.2	Option board slots	210
7.3	Real time clock	211

7.4	Power unit settings	211
7.5	Keypad	213
7.6	Fieldbus	213
8	User settings, favourites and user level menus	218
8.1	User settings	218
8.1.1	Parameter backup	219
8.2	Favourites	219
8.2.1	Adding an item to the Favourites	220
8.2.2	Removing an item from the Favourites	220
8.3	User levels	221
8.3.1	Changing the access code of the user levels	222
9	Parameter descriptions	224
9.1	Motor settings	224
9.1.1	I/f start function	232
9.1.2	Torque stabilator function	233
9.2	Start/Stop setup	234
9.3	References	241
9.3.1	Frequency reference	241
9.3.2	Torque reference	241
9.3.3	Preset frequencies	243
9.3.4	Motor potentiometer parameters	246
9.4	Joystick parameters	248
9.5	Jogging parameters	249
9.6	Ramps and brakes setup	251
9.7	I/O configuration	252
9.7.1	Programming of digital and analogue inputs	252
9.7.2	Default functions of programmable inputs	263
9.7.3	Digital inputs	263
9.7.4	Analogue inputs	264
9.7.5	Digital outputs	269
9.7.6	Analogue outputs	271
9.8	Prohibit frequencies	274
9.9	Supervisions	275
9.9.1	Motor thermal protections	276
9.9.2	Motor stall protection	279
9.9.3	Underload protection	280
9.10	Automatic reset	285
9.11	Timer functions	286
9.12	PID controller	290
9.12.1	Feedforward	291
9.12.2	Sleep function	291
9.12.3	Feedback supervision	293
9.12.4	Pressure loss compensation	294
9.12.5	Soft fill	296
9.12.6	Input pressure supervision	297
9.12.7	Frost protection	298

9.13	Multipump function	299
9.14	Maintenance counters	305
9.15	Fire mode	305
9.16	Motor preheat function	307
9.17	Mechanical brake	308
9.18	Pump control	311
9.18.1	Auto-cleaning	311
9.18.2	Jockey pump	312
9.18.3	Priming pump	313
9.19	Total and trip counters	314
9.19.1	Operating time counter	314
9.19.2	Operating time trip counter	315
9.19.3	Run time counter	315
9.19.4	Power on time counter	316
9.19.5	Energy counter	316
9.19.6	Energy trip counter	317
10	Fault tracing	319
10.1	A fault comes into view	319
10.1.1	Resetting with the Reset button	319
10.1.2	Resetting with a parameter in the graphical display	319
10.1.3	Resetting with a parameter in the text display	320
10.2	Fault history	321
10.2.1	Examining the Fault history in the graphical display	321
10.2.2	Examining the Fault history in the text display	322
10.3	Fault codes	324
11	Appendix 1	337
11.1	The default values of parameters in the different applications	337

1 QUICK STARTUP GUIDE

1.1 CONTROL PANEL AND KEYPAD

The control panel is the interface between the AC drive and the user. With the control panel, you can control the speed of a motor and monitor the status of the AC drive. You can also set the parameters of the AC drive.

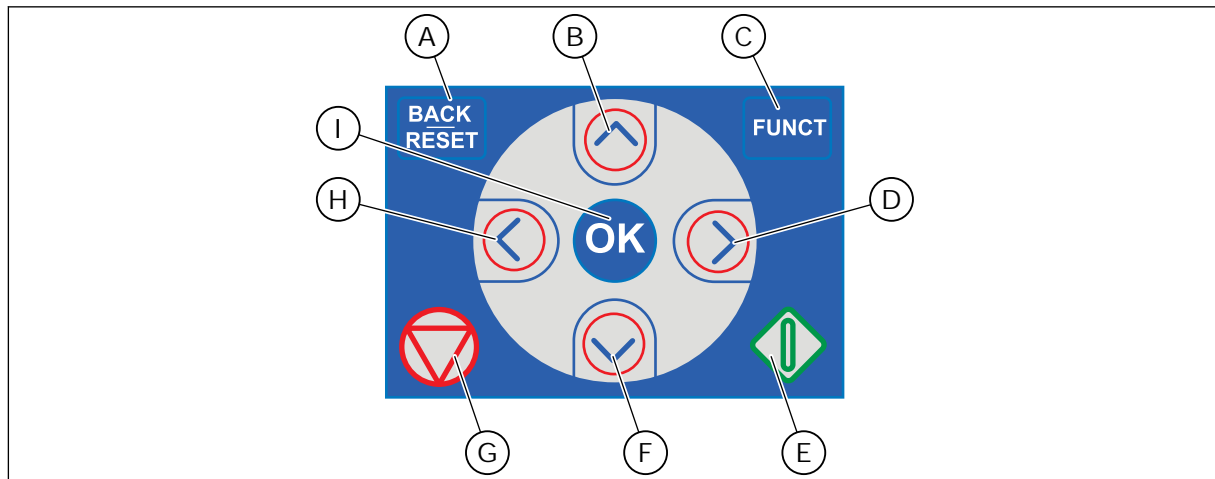

Fig. 1: The buttons of the keypad

- | | |
|--|--|
| <p>A. The BACK/RESET button. Use it to move back in the menu, exit the Edit mode, reset a fault.</p> <p>B. The arrow button UP. Use it to scroll the menu up and to increase a value.</p> <p>C. The FUNCT button. Use it to change the rotation direction of the motor, access the control page, and change the control place. See more in <i>Table 38 Frequency reference parameters</i>.</p> | <p>D. The arrow button RIGHT.</p> <p>E. The START button.</p> <p>F. The arrow button DOWN. Use it to scroll the menu down and to decrease a value.</p> <p>G. The STOP button.</p> <p>H. The arrow button LEFT. Use it to move the cursor left.</p> <p>I. The OK button. Go into an active level or item, accept a selection.</p> |
|--|--|

1.2 THE DISPLAYS

There are 2 display types: the graphical display and the text display. The control panel always has the same keypad and buttons.

The display shows this data.

- The status of the motor and the drive.
- Faults in the motor and in the drive.
- Your location in the menu structure.

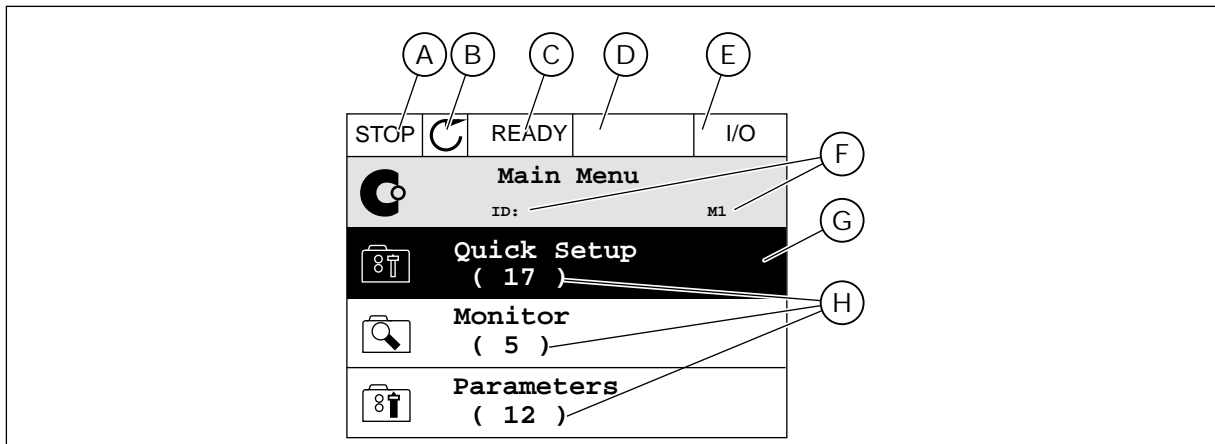

Fig. 2: The graphical display

- A. The first status field: STOP/RUN
- B. The rotation direction of the motor
- C. The second status field: READY/NOT READY/FAULT
- D. The alarm field: ALARM/-
- E. The control place field: PC/I/O/KEYPAD/ FIELDBUS
- F. The location field: the ID number of the parameter and the current location in the menu
- G. An activated group or item
- H. The number of items in the group in question

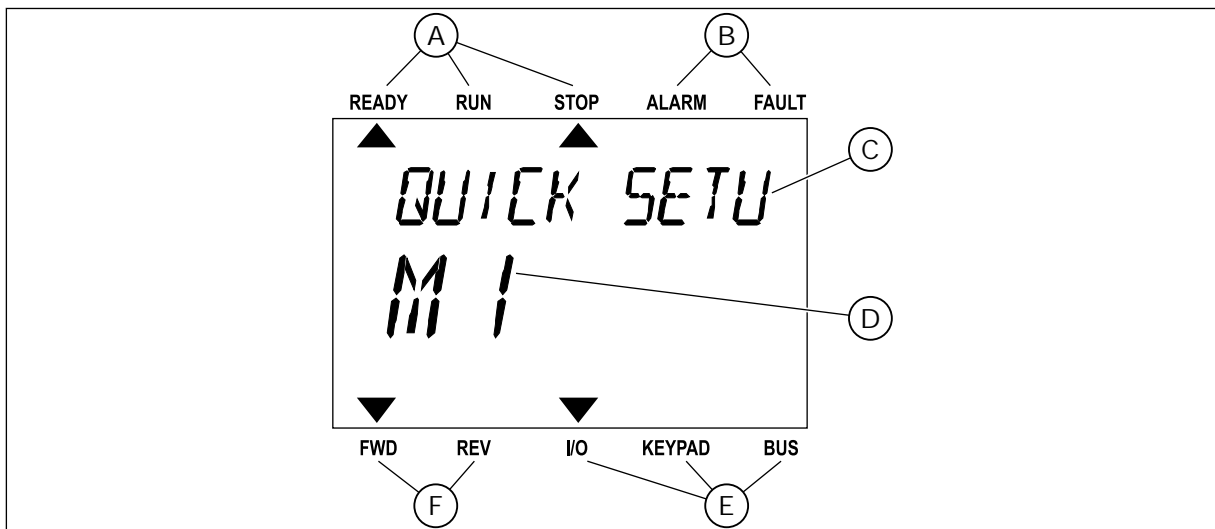

Fig. 3: The text display. If the text is too long to show, the text scrolls automatically on the display.

- A. The indicators of status
- B. The indicators of alarm and fault
- C. The name of the group or item of the current location
- D. The current location in the menu
- E. The indicators of the control place
- F. The indicators of the rotation direction

1.3 FIRST START-UP

The Start-up wizard tells you to give necessary data for the drive to control your procedure.

1	Language selection (P6.1)	The selection is different in all the language packages
2	Daylight saving* (P5.5.5)	Russia US EU OFF
3	Time* (P5.5.2)	hh:mm:ss
4	Year* (P5.5.4)	yyyy
5	Date* (P5.5.3)	dd.mm.

* If a battery is installed, you see these questions.

6	Run Startup wizard?	Yes No
---	---------------------	-----------

To set the parameter values manually, make the selection *No* and push the OK button.

7	Make a selection of an application (P1.2 Application, ID212)	Standard Local/Remote Multi-step speed PID control Multi-purpose Motor potentiometer
8	Set a value for P3.1.2.2 Motor Type (so that it agrees with the nameplate)	PM motor Induction motor
9	Set a value for P3.1.1.1 Motor Nominal Voltage (so that it agrees with the nameplate)	Range: Varies
10	Set a value for P3.1.1.2 Motor Nominal Frequency (so that it agrees with the nameplate)	Range: 8.00...320.00 Hz
11	Set a value for P3.1.1.3 Motor Nominal Speed (so that it agrees with the nameplate)	Range: 24...19200
12	Set a value for P3.1.1.4 Motor Nominal Current	Range: Varies
13	Set a value for P3.1.1.5 Motor Cos Phi	Range: 0.30-1.00

If you set Motor Type to *Induction Motor*, you see the next question. If your selection is *PM Motor*, the value of parameter P3.1.1.5 Motor Cos Phi is set to 1.00 and the wizard goes directly to question 14.

14	Set a value for P3.3.1.1 Minimum Frequency Reference	Range: 0.00...P3.3.1.2 Hz
15	Set a value for P3.3.1.2 Maximum Frequency Reference	Range: P3.3.1.1...320.00 Hz
16	Set a value for P3.4.1.2 Acceleration Time 1	Range: 0.1...300.0 s
17	Set a value for P3.4.1.3 Deceleration Time 1	Range: 0.1...300.0 s
18	Run the Application wizard?	Yes No

To continue to the application wizard, set the selection to *Yes* and push the OK button. See the description of the different application wizards in Chapter 2 *Wizards*.

After these selections, the Start-up wizard is completed. To start the Start-up wizard again, you have 2 alternatives. Go to the parameter P6.5.1 Restore Factory Defaults or to the parameter B1.1.2 Start-up Wizard. Then set the value to *Activate*.

1.4 DESCRIPTION OF THE APPLICATIONS

Use the parameter P1.2 (Application) to make a selection of an application for the drive. Immediately when the parameter P1.2 changes, a group of parameters get their preset values.

1.4.1 STANDARD APPLICATION

You can use the Standard application in speed-controlled processes where no special functions are necessary, for example pumps, fans, or conveyors.

It is possible to control the drive from the keypad, Fieldbus or I/O terminal.

When you control the drive with the I/O terminal, the frequency reference signal is connected to AI1 (0...10V) or AI2 (4...20mA). The connection depends the type of the signal. There are also 3 preset frequency references available. You can activate the preset frequency references with DI4 and DI5. The start/stop signals of the drive are connected to DI1 (start forward) and DI2 (start reverse).

It is possible to configure all the drive outputs freely in all the applications. There are 1 analogue output (Output Frequency) and 3 relay outputs (Run, Fault, Ready) available on the basic I/O board.

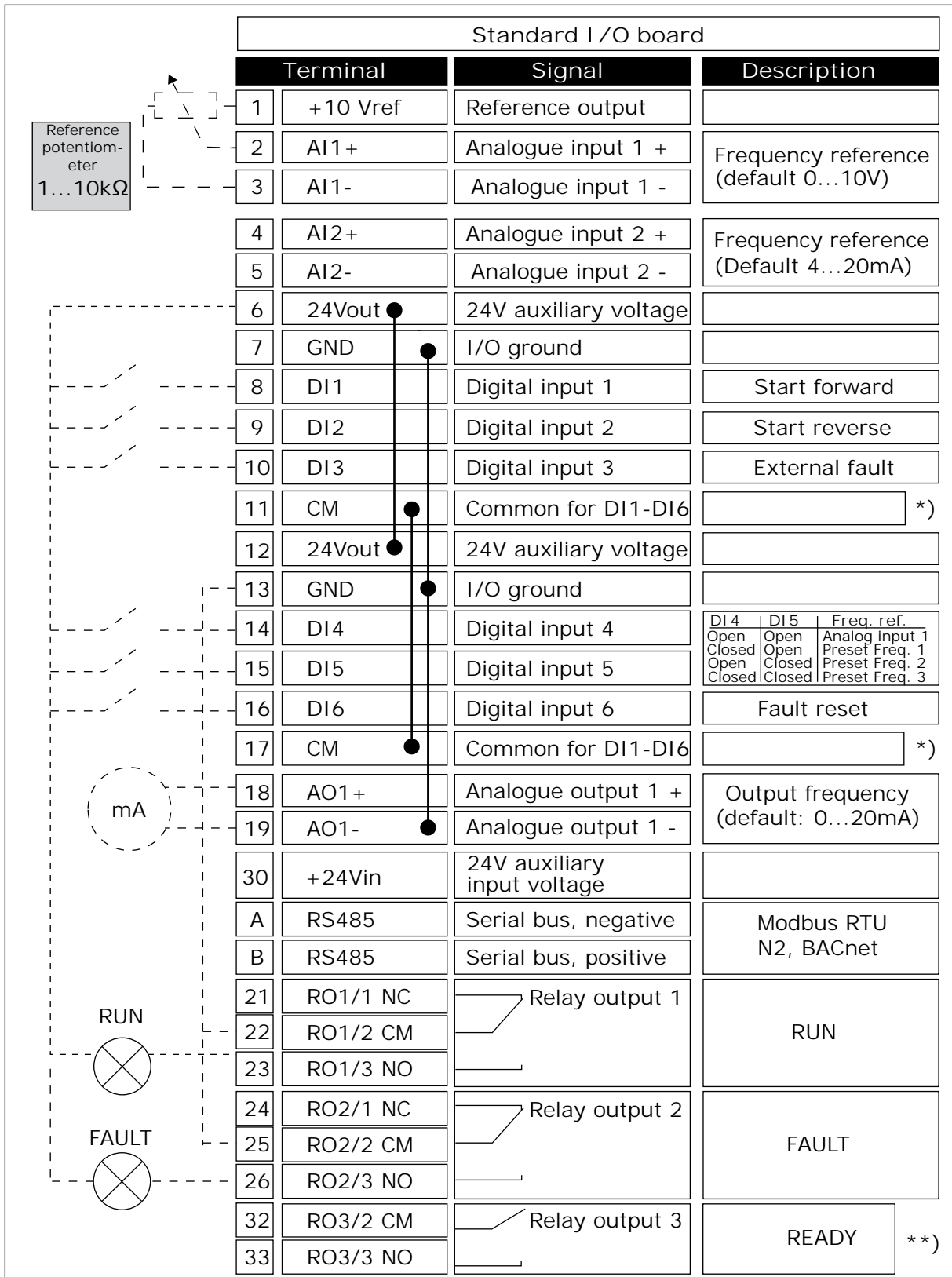

Fig. 4: The default control connections of the Standard application

* = You can isolate the digital inputs from the ground with a DIP switch.

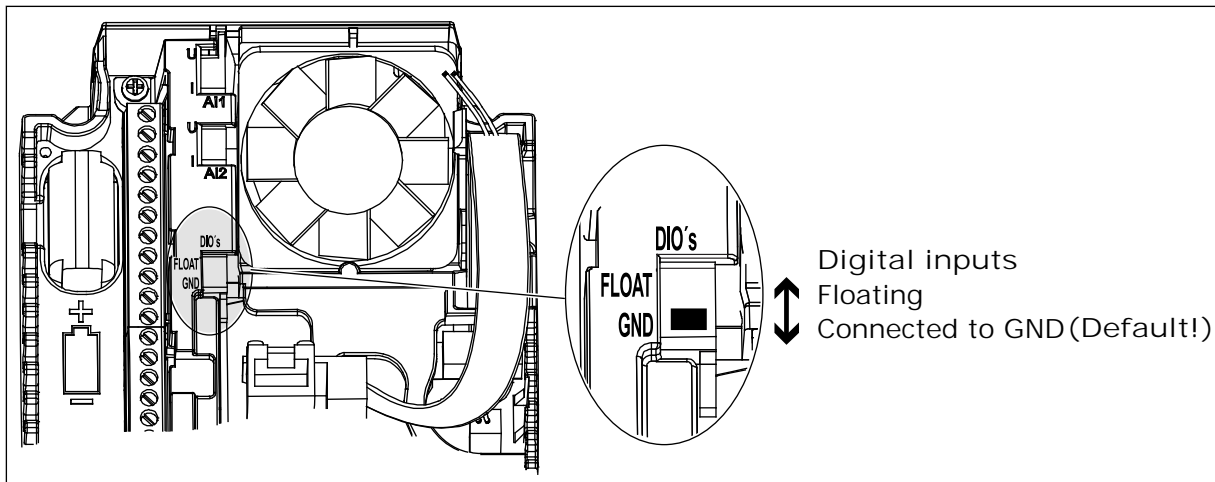

Fig. 5: The DIP switch

Table 2: M1.1 Wizards

Index	Parameter	Min	Max	Unit	Default	ID	Description
1.1.1	Startup wizard	0	1		0	1170	0 = Do not activate 1 = Activate The selection Activate starts the Start-up wizard (see Chapter <i>Table 1 The Start-up wizard</i>).
1.1.3	Multi-pump Wizard	0	1		0	1671	The selection Activate starts the Multipump wizard (see Chapter <i>2.7 Multipump wizard</i>).
1.1.4	Fire mode Wizard	0	1		0	1672	The selection Activate starts the Fire mode wizard (see Chapter <i>2.8 Fire mode wizard</i>).

Table 3: M1 Quick Setup

Index	Parameter	Min	Max	Unit	Default	ID	Description
1.2 	Application	0	5		0	212	0 = Standard 1 = Local/Remote 2 = Multi-Step Speed 3 = PID Control 4 = Multi-Purpose 5 = Motor Potentiometer
1.3	Minimum Frequency Reference	0.00	P1.4	Hz	0.0	101	The minimum frequency reference that is acceptable.
1.4	Maximum Frequency Reference	P1.3	320.0	Hz	50.0 / 60.0	102	The maximum frequency reference that is acceptable.
1.5	Acceleration Time 1	0.1	300.0	s	5.0	103	Gives the quantity of time that is necessary for the output frequency to increase from zero frequency to the maximum frequency.
1.6	Deceleration Time 1	0.1	300.0	s	5.0	104	Gives the quantity of time that is necessary for the output frequency to decrease from the maximum frequency to zero frequency.
1.7	Motor Current Limit	I _H *0.1	I _S	A	Varies	107	The maximum motor current from the AC drive.
1.8	Motor Type	0	1		0	650	0 = Induction Motor 1 = Permanent Magnet Motor
1.9	Motor Nominal Voltage	Varies	Varies	V	Varies	110	Find this value U _n on the rating plate of the motor. NOTE! Find out if the motor connection is Delta or Star.

Table 3: M1 Quick Setup

Index	Parameter	Min	Max	Unit	Default	ID	Description
1.10	Motor Nominal Frequency	8.0	320.0	Hz	50 / 60	111	Find this value f_n on the rating plate of the motor.
1.11	Motor Nominal Speed	24	19200	Rpm	Varies	112	Find this value n_n on the rating plate of the motor.
1.12	Motor Nominal Current	$I_H * 0.1$	$I_H * 2$	A	Varies	113	Find this value I_n on the rating plate of the motor.
1.13	Motor Cos Phi (Power Factor)	0.30	1.00		Varies	120	Find this value on the rating plate of the motor.
1.14	Energy Optimization	0	1		0	666	The drive searches for the minimum motor current to save energy and to lower the motor noise. Use this function with, for example, fan and pump processes. 0 = Disabled 1 = Enabled
1.15	Identification	0	2		0	631	The identification run calculates or measures the motor parameters that are necessary for a good control of the motor and speed. 0 = No action 1 = At standstill 2 = With rotation Before you do the identification run, you must set the motor nameplate parameters.
1.16	Start Function	0	1		0	505	0 = Ramping 1 = Flying Start
1.17	Stop Function	0	1		0	506	0 = Coasting 1 = Ramping

Table 3: M1 Quick Setup

Index	Parameter	Min	Max	Unit	Default	ID	Description
1.18	Automatic Reset	0	1		0	731	0 = Disabled 1 = Enabled
1.19	Response to External Fault	0	3		2	701	0 = No action 1 = Alarm 2 = Fault (Stop according to stop mode) 3 = Fault (Stop by coasting)
1.20	Response to AI Low Fault	0	5		0	700	0 = No action 1 = Alarm 2 = Alarm+preset fault frequency (P3.9.1.13) 3 = Alarm + previous frequency 4 = Fault (Stop according to stop mode) 5 = Fault (Stop by coasting)
1.21	Remote Control Place	0	1		0	172	The selection of the remote control place (start/stop). 0 = I/O control 1 = Fieldbus control

Table 3: M1 Quick Setup

Index	Parameter	Min	Max	Unit	Default	ID	Description
1.22	I/O Control Reference A Selection	0	9		5	117	<p>The selection of the frequency reference source when the control place is I/O A.</p> <p>0 = Preset Frequency 0 1 = Keypad Reference 2 = Fieldbus 3 = AI1 4 = AI2 5 = AI1+AI2 6 = PID Reference 7 = Motor Potentiometer 8 = Joystick Reference 9 = Jogging Reference 10 = Block Out.1 11 = Block Out.2 12 = Block Out.3 13 = Block Out.4 14 = Block Out.5 15 = Block Out.6 16 = Block Out.7 17 = Block Out.8 18 = Block Out.9 19 = Block Out.10</p> <p>The application that you set with parameter 1.2 gives the default value.</p>
1.23	Keypad Control Reference Selection	0	9		1	121	<p>The selection of the frequency reference source when the control place is keypad. See P1.22.</p>
1.24	Fieldbus Control Reference Selection	0	9		2	122	<p>The selection of the frequency reference source when the control place is fieldbus. See P1.22.</p>
1.25	AI1 Signal Range	0	1		0	379	<p>0= 0..10V / 0..20mA 1= 2..10V / 4..20mA</p>
1.26	AI2 Signal Range	0	1		1	390	<p>0= 0..10V / 0..20mA 1= 2..10V / 4..20mA</p>
1.27	R01 Function	0	51		2	1101	See P3.5.3.2.1

Table 3: M1 Quick Setup

Index	Parameter	Min	Max	Unit	Default	ID	Description
1.28	R02 Function	0	51		3	1104	See P3.5.3.2.1
1.29	R03 Function	0	51		1	1107	See P3.5.3.2.1
1.30	A01 Function	0	31		2	10050	See P3.5.4.1.1

Table 4: M1.31 Standard

Index	Parameter	Min	Max	Unit	Default	ID	Description
1.31.1	Preset Frequency 1	P1.3	P1.4	Hz	10.0	105	Make the selection of a preset frequency with the digital input DI4.
1.31.2	Preset Frequency 2	P1.3	P1.4	Hz	15.0	106	Make the selection of a preset frequency with the digital input DI5.
1.31.3	Preset Frequency 3	P1.3	P1.4	Hz	20.0	126	Make the selection of a preset frequency with the digital input DI4 and DI5.

1.4.2 LOCAL/REMOTE APPLICATION

Use the Local/Remote application when, for example, it is necessary to switch between 2 different control places.

To change between the Local and the Remote control place, use DI6. When Remote control is active, you can give the start/stop commands from Fieldbus or from I/O terminal (DI1 and DI2). When Local control is active, you can give the start/stop commands from the keypad, Fieldbus or I/O terminal (DI4 and DI5).

For each control place, you can make a selection of the frequency reference from the keypad, Fieldbus or I/O terminal (AI1 or AI2).

It is possible to configure all the drive outputs freely in all the applications. There are 1 analogue output (Output Frequency) and 3 relay outputs (Run, Fault, Ready) available on the basic I/O board.

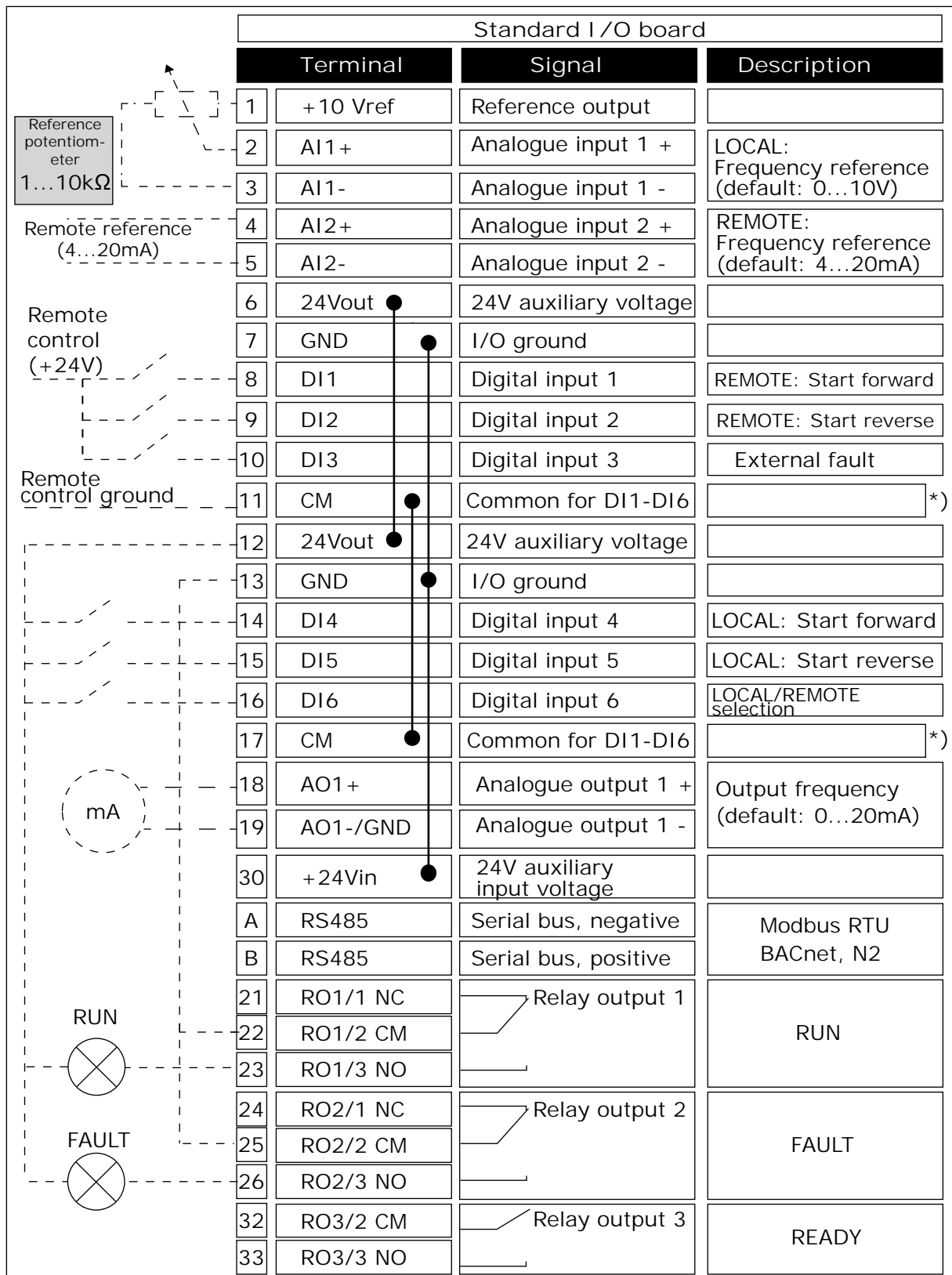

Fig. 6: The default control connections of the Local/Remote application

* = You can isolate the digital inputs from the ground with a DIP switch.

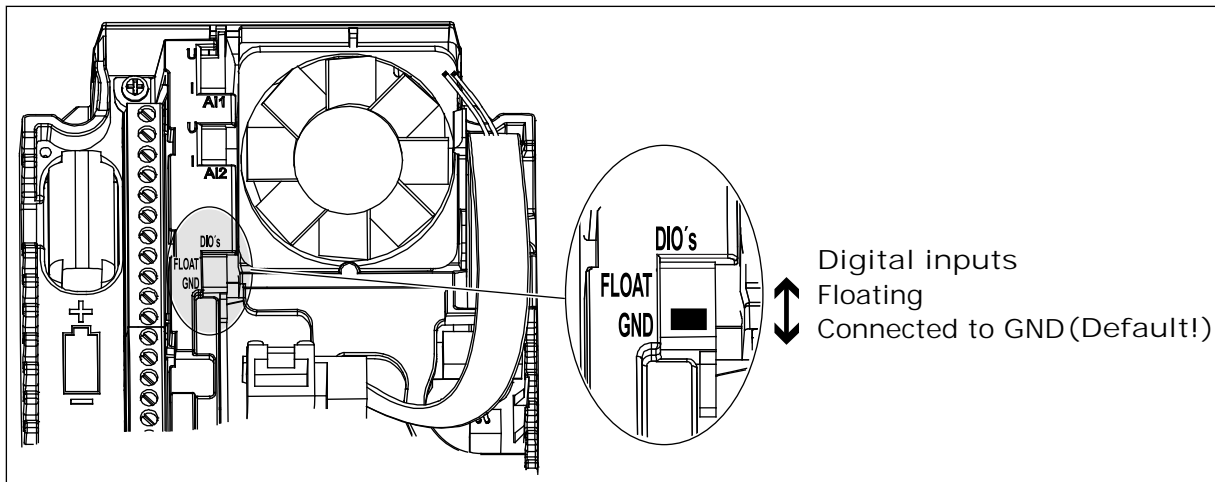

Fig. 7: The DIP switch

Table 5: M1.1 Wizards

Index	Parameter	Min	Max	Unit	Default	ID	Description
1.1.1	Startup wizard	0	1		0	1170	0 = Do not activate 1 = Activate The selection Activate starts the Start-up wizard (see Chapter <i>Table 1 The Start-up wizard</i>).
1.1.3	Multi-pump Wizard	0	1		0	1671	The selection Activate starts the Multipump wizard (see Chapter <i>2.7 Multipump wizard</i>).
1.1.4	Fire mode Wizard	0	1		0	1672	The selection Activate starts the Fire mode wizard (see Chapter <i>2.8 Fire mode wizard</i>).

Table 6: M1 Quick Setup

Index	Parameter	Min	Max	Unit	Default	ID	Description
1.2 	Application	0	5		1	212	0 = Standard 1 = Local/Remote 2 = Multi-Step Speed 3 = PID Control 4 = Multi-Purpose 5 = Motor Potentiometer
1.3	Minimum Frequency Reference	0.00	P1.4	Hz	0.0	101	The minimum frequency reference that is acceptable.
1.4	Maximum Frequency Reference	P1.3	320.0	Hz	50.0 / 60.0	102	The maximum frequency reference that is acceptable.
1.5	Acceleration Time 1	0.1	300.0	s	5.0	103	Gives the quantity of time that is necessary for the output frequency to increase from zero frequency to the maximum frequency.
1.6	Deceleration Time 1	0.1	300.0	s	5.0	104	Gives the quantity of time that is necessary for the output frequency to decrease from the maximum frequency to zero frequency.
1.7	Motor Current Limit	I _H *0.1	I _S	A	Varies	107	The maximum motor current from the AC drive.
1.8	Motor Type	0	1		0	650	0 = Induction Motor 1 = Permanent Magnet Motor
1.9	Motor Nominal Voltage	Varies	Varies	V	Varies	110	Find this value U _n on the rating plate of the motor. NOTE! Find out if the motor connection is Delta or Star.

Table 6: M1 Quick Setup

Index	Parameter	Min	Max	Unit	Default	ID	Description
1.10	Motor Nominal Frequency	8.0	320.0	Hz	50 / 60	111	Find this value f_n on the rating plate of the motor.
1.11	Motor Nominal Speed	24	19200	Rpm	Varies	112	Find this value n_n on the rating plate of the motor.
1.12	Motor Nominal Current	$I_H * 0.1$	$I_H * 2$	A	Varies	113	Find this value I_n on the rating plate of the motor.
1.13	Motor Cos Phi (Power Factor)	0.30	1.00		Varies	120	Find this value on the rating plate of the motor.
1.14	Energy Optimization	0	1		0	666	The drive searches for the minimum motor current to save energy and to lower the motor noise. Use this function with, for example, fan and pump processes. 0 = Disabled 1 = Enabled
1.15	Identification	0	2		0	631	The identification run calculates or measures the motor parameters that are necessary for a good control of the motor and speed. 0 = No action 1 = At standstill 2 = With rotation Before you do the identification run, you must set the motor nameplate parameters.
1.16	Start Function	0	1		0	505	0 = Ramping 1 = Flying Start
1.17	Stop Function	0	1		0	506	0 = Coasting 1 = Ramping

Table 6: M1 Quick Setup

Index	Parameter	Min	Max	Unit	Default	ID	Description
1.18	Automatic Reset	0	1		0	731	0 = Disabled 1 = Enabled
1.19	Response to External Fault	0	3		2	701	0 = No action 1 = Alarm 2 = Fault (Stop according to stop mode) 3 = Fault (Stop by coasting)
1.20	Response to AI Low Fault	0	5		0	700	0 = No action 1 = Alarm 2 = Alarm+preset fault frequency (P3.9.1.13) 3 = Alarm + previous frequency 4 = Fault (Stop according to stop mode) 5 = Fault (Stop by coasting)
1.21	Remote Control Place	0	1		0	172	The selection of the remote control place (start/stop). 0 = I/O control 1 = Fieldbus control

Table 6: M1 Quick Setup

Index	Parameter	Min	Max	Unit	Default	ID	Description
1.22	I/O Control Reference A Selection	0	9		3	117	<p>The selection of the frequency reference source when the control place is I/O A.</p> <p>0 = Preset Frequency 1 = Keypad Reference 2 = Fieldbus 3 = AI1 4 = AI2 5 = AI1+AI2 6 = PID Reference 7 = Motor Potentiometer 8 = Joystick Reference 9 = Jogging Reference 10 = Block Out.1 11 = Block Out.2 12 = Block Out.3 13 = Block Out.4 14 = Block Out.5 15 = Block Out.6 16 = Block Out.7 17 = Block Out.8 18 = Block Out.9 19 = Block Out.10</p> <p>The application that you set with parameter 1.2 gives the default value.</p>
1.23	Keypad Control Reference Selection	0	9		1	121	<p>The selection of the frequency reference source when the control place is keypad. See P1.22.</p>
1.24	Fieldbus Control Reference Selection	0	9		2	122	<p>The selection of the frequency reference source when the control place is fieldbus. See P1.22.</p>
1.25	AI1 Signal Range	0	1		0	379	<p>0= 0..10V / 0..20mA 1= 2..10V / 4..20mA</p>
1.26	AI2 Signal Range	0	1		1	390	<p>0= 0..10V / 0..20mA 1= 2..10V / 4..20mA</p>
1.27	R01 Function	0	51		2	1101	See P3.5.3.2.1

Table 6: M1 Quick Setup

Index	Parameter	Min	Max	Unit	Default	ID	Description
1.28	R02 Function	0	51		3	1104	See P3.5.3.2.1
1.29	R03 Function	0	51		1	1107	See P3.5.3.2.1
1.30	A01 Function	0	31		2	10050	See P3.5.4.1.1

Table 7: M1.32 Local/Remote

Index	Parameter	Min	Max	Unit	Default	ID	Description
1.32.1	I/O Control Reference B Selection	1	20		4	131	See P1.22
1.32.2	I/O B Control Force				DigIN SlotA.6	425	TRUE = Force control place to I/O B
1.32.3	I/O B Reference Force				DigIN SlotA.6	343	TRUE = Used frequency reference is specified by I/O Reference B parameter (P1.32.1)
1.32.4	Control Signal 1 B				DigIN SlotA.4	423	Start signal 1 when control place is I/O B
1.32.5	Control Signal 2 B				DigIN SlotA.5	424	Start signal 1 when control place is I/O B
1.32.6	Keypad Control Force				DigIN SlotA.1	410	Force Control to Keypad
1.32.7	Fieldbus Control Force				DigIN Slot0.1	411	Force Control to Fieldbus
1.32.8	External Fault (Close)				DigIN SlotA.3	405	FALSE = OK TRUE = External fault
1.32.9	Fault Reset (Close)				DigIN Slot0.1	414	Resets all active faults when TRUE

1.4.3 MULTI-STEP SPEED APPLICATION

You can use the Multi-step speed application with processes where more than 1 fixed frequency reference is necessary (for example test benches).

It is possible to use 1 + 7 frequency references: 1 basic reference (AI1 or AI2) and 7 preset references.

Make a selection of the preset frequency references with digital signals DI4, DI5 and DI6. If none of these inputs are active, the frequency reference is removed from the analogue input (AI1 or AI2). Give the start/stop commands from the I/O terminal (DI1 and DI2).

It is possible to configure all the drive outputs freely in all the applications. There are 1 analogue output (Output Frequency) and 3 relay outputs (Run, Fault, Ready) available on the basic I/O board.

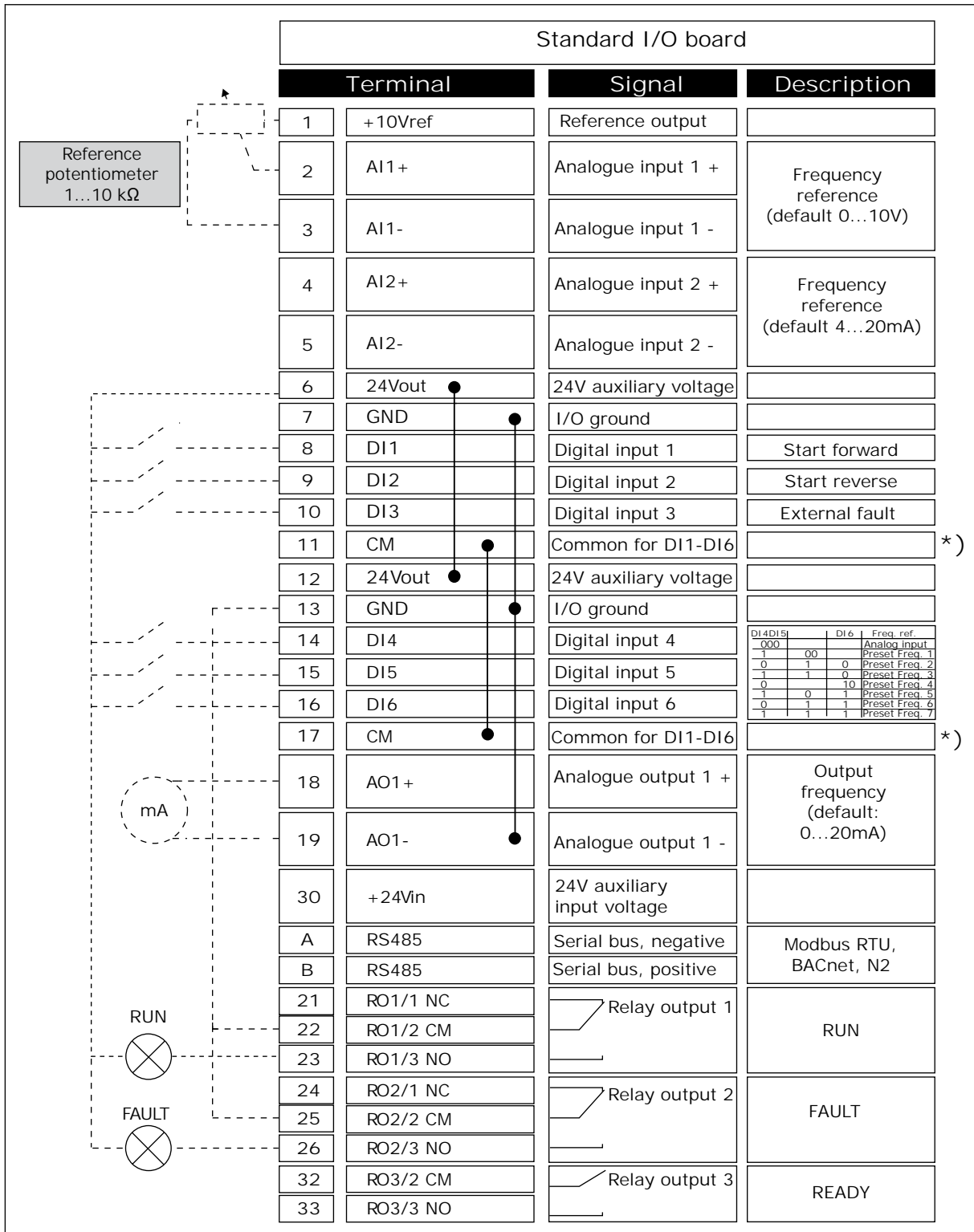

Fig. 8: The default control connections of the Multi-step speed application

* = You can isolate the digital inputs from the ground with a DIP switch.

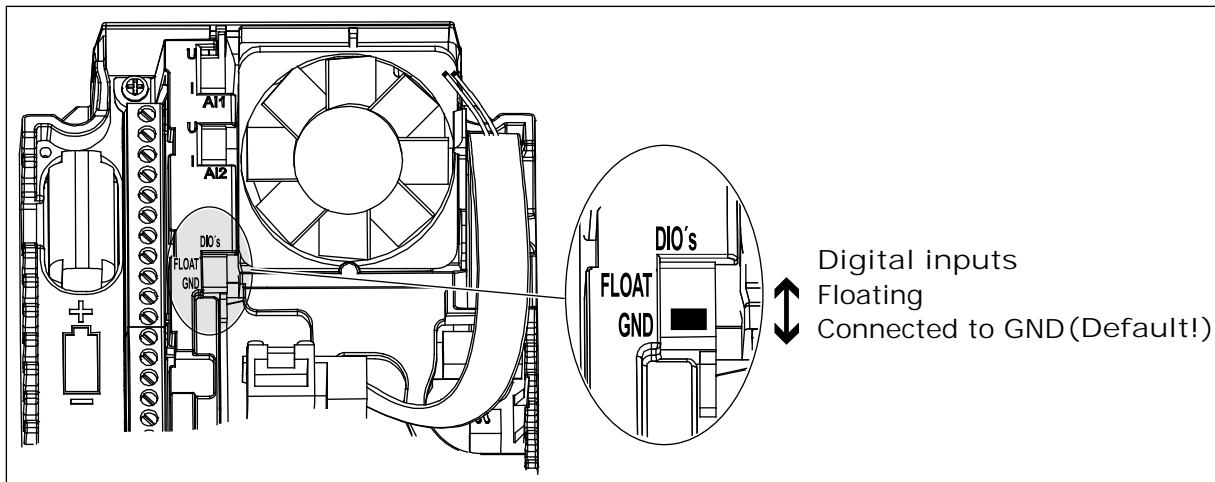

Fig. 9: The DIP switch

Table 8: M1.1 Wizards

Index	Parameter	Min	Max	Unit	Default	ID	Description
1.1.1	Startup wizard	0	1		0	1170	0 = Do not activate 1 = Activate The selection Activate starts the Start-up wizard (see Chapter <i>Table 1 The Start-up wizard</i>).
1.1.3	Multi-pump Wizard	0	1		0	1671	The selection Activate starts the Multipump wizard (see Chapter <i>2.7 Multipump wizard</i>).
1.1.4	Fire mode Wizard	0	1		0	1672	The selection Activate starts the Fire mode wizard (see Chapter <i>2.8 Fire mode wizard</i>).

Table 9: M1 Quick Setup

Index	Parameter	Min	Max	Unit	Default	ID	Description
1.2 	Application	0	5		2	212	0 = Standard 1 = Local/Remote 2 = Multi-Step Speed 3 = PID Control 4 = Multi-Purpose 5 = Motor Potentiometer
1.3	Minimum Frequency Reference	0.00	P1.4	Hz	0.0	101	The minimum frequency reference that is acceptable.
1.4	Maximum Frequency Reference	P1.3	320.0	Hz	50.0 / 60.0	102	The maximum frequency reference that is acceptable.
1.5	Acceleration Time 1	0.1	300.0	s	5.0	103	Gives the quantity of time that is necessary for the output frequency to increase from zero frequency to the maximum frequency.
1.6	Deceleration Time 1	0.1	300.0	s	5.0	104	Gives the quantity of time that is necessary for the output frequency to decrease from the maximum frequency to zero frequency.
1.7	Motor Current Limit	I _H *0.1	I _S	A	Varies	107	The maximum motor current from the AC drive.
1.8	Motor Type	0	1		0	650	0 = Induction Motor 1 = Permanent Magnet Motor
1.9	Motor Nominal Voltage	Varies	Varies	V	Varies	110	Find this value U _n on the rating plate of the motor. NOTE! Find out if the motor connection is Delta or Star.

Table 9: M1 Quick Setup

Index	Parameter	Min	Max	Unit	Default	ID	Description
1.10	Motor Nominal Frequency	8.0	320.0	Hz	50 / 60	111	Find this value f_n on the rating plate of the motor.
1.11	Motor Nominal Speed	24	19200	Rpm	Varies	112	Find this value n_n on the rating plate of the motor.
1.12	Motor Nominal Current	$I_H * 0.1$	$I_H * 2$	A	Varies	113	Find this value I_n on the rating plate of the motor.
1.13	Motor Cos Phi (Power Factor)	0.30	1.00		Varies	120	Find this value on the rating plate of the motor.
1.14	Energy Optimization	0	1		0	666	The drive searches for the minimum motor current to save energy and to lower the motor noise. Use this function with, for example, fan and pump processes. 0 = Disabled 1 = Enabled
1.15	Identification	0	2		0	631	The identification run calculates or measures the motor parameters that are necessary for a good control of the motor and speed. 0 = No action 1 = At standstill 2 = With rotation Before you do the identification run, you must set the motor nameplate parameters.
1.16	Start Function	0	1		0	505	0 = Ramping 1 = Flying Start
1.17	Stop Function	0	1		0	506	0 = Coasting 1 = Ramping

Table 9: M1 Quick Setup

Index	Parameter	Min	Max	Unit	Default	ID	Description
1.18	Automatic Reset	0	1		0	731	0 = Disabled 1 = Enabled
1.19	Response to External Fault	0	3		2	701	0 = No action 1 = Alarm 2 = Fault (Stop according to stop mode) 3 = Fault (Stop by coasting)
1.20	Response to AI Low Fault	0	5		0	700	0 = No action 1 = Alarm 2 = Alarm+preset fault frequency (P3.9.1.13) 3 = Alarm + previous frequency 4 = Fault (Stop according to stop mode) 5 = Fault (Stop by coasting)
1.21	Remote Control Place	0	1		0	172	The selection of the remote control place (start/stop). 0 = I/O control 1 = Fieldbus control

Table 9: M1 Quick Setup

Index	Parameter	Min	Max	Unit	Default	ID	Description
1.22	I/O Control Reference A Selection	0	9		5	117	<p>The selection of the frequency reference source when the control place is I/O A.</p> <p>0 = Preset Frequency 1 = Keypad Reference 2 = Fieldbus 3 = AI1 4 = AI2 5 = AI1+AI2 6 = PID Reference 7 = Motor Potentiometer 8 = Joystick Reference 9 = Jogging Reference 10 = Block Out.1 11 = Block Out.2 12 = Block Out.3 13 = Block Out.4 14 = Block Out.5 15 = Block Out.6 16 = Block Out.7 17 = Block Out.8 18 = Block Out.9 19 = Block Out.10</p> <p>The application that you set with parameter 1.2 gives the default value.</p>
1.23	Keypad Control Reference Selection	0	9		1	121	<p>The selection of the frequency reference source when the control place is keypad. See P1.22.</p>
1.24	Fieldbus Control Reference Selection	0	9		2	122	<p>The selection of the frequency reference source when the control place is fieldbus. See P1.22.</p>
1.25	AI1 Signal Range	0	1		0	379	<p>0= 0..10V / 0..20mA 1= 2..10V / 4..20mA</p>
1.26	AI2 Signal Range	0	1		1	390	<p>0= 0..10V / 0..20mA 1= 2..10V / 4..20mA</p>
1.27	R01 Function	0	51		2	1101	See P3.5.3.2.1

Table 9: M1 Quick Setup

Index	Parameter	Min	Max	Unit	Default	ID	Description
1.28	RO2 Function	0	51		3	1104	See P3.5.3.2.1
1.29	RO3 Function	0	51		1	1107	See P3.5.3.2.1
1.30	A01 Function	0	31		2	10050	See P3.5.4.1.1

Table 10: M1.33 Multi-step speed

Index	Parameter	Min	Max	Unit	Default	ID	Description
1.33.1	Preset Frequency 1	P1.3	P1.4	Hz	10.0	105	
1.33.2	Preset Frequency 2	P1.3	P1.4	Hz	15.0	106	
1.33.3	Preset Frequency 3	P1.3	P1.4	Hz	20.0	126	
1.33.4	Preset Frequency 4	P1.3	P1.4	Hz	25.0	127	
1.33.5	Preset Frequency 5	P1.3	P1.4	Hz	30.0	128	
1.33.6	Preset Frequency 6	P1.3	P1.4	Hz	40.0	129	
1.33.7	Preset Frequency 7	P1.3	P1.4	Hz	50.0	130	
1.33.8	Preset Frequency Mode	0	1		0	128	0 = Binary Coded 1 = Number of inputs. Preset frequency is selected according to how many of preset speed digital inputs are active.
1.33.9	External Fault (Close)				DigIN SlotA.3	405	FALSE = OK TRUE = External fault
1.33.10	Fault Reset (Close)				DigIN Slot0.1	414	Resets all active faults when TRUE

1.4.4 PID CONTROL APPLICATION

You can use the PID control application with processes where you control the process variable (for example pressure) through control of the speed of the motor.

In this application, the internal PID controller of the drive is configured for 1 setpoint and 1 feedback signal.

It is possible to use 2 control places. Make the selection of the control place A or B with DI6. When control place A is active, the start/stop commands are given by DI1, and the PID controller gives the frequency reference. When control place B is active, start/stop commands are given by DI4, and AI1 gives the frequency reference.

It is possible to configure all the drive outputs freely in all the applications. There are 1 analogue output (Output Frequency) and 3 relay outputs (Run, Fault, Ready) available on the basic I/O board.

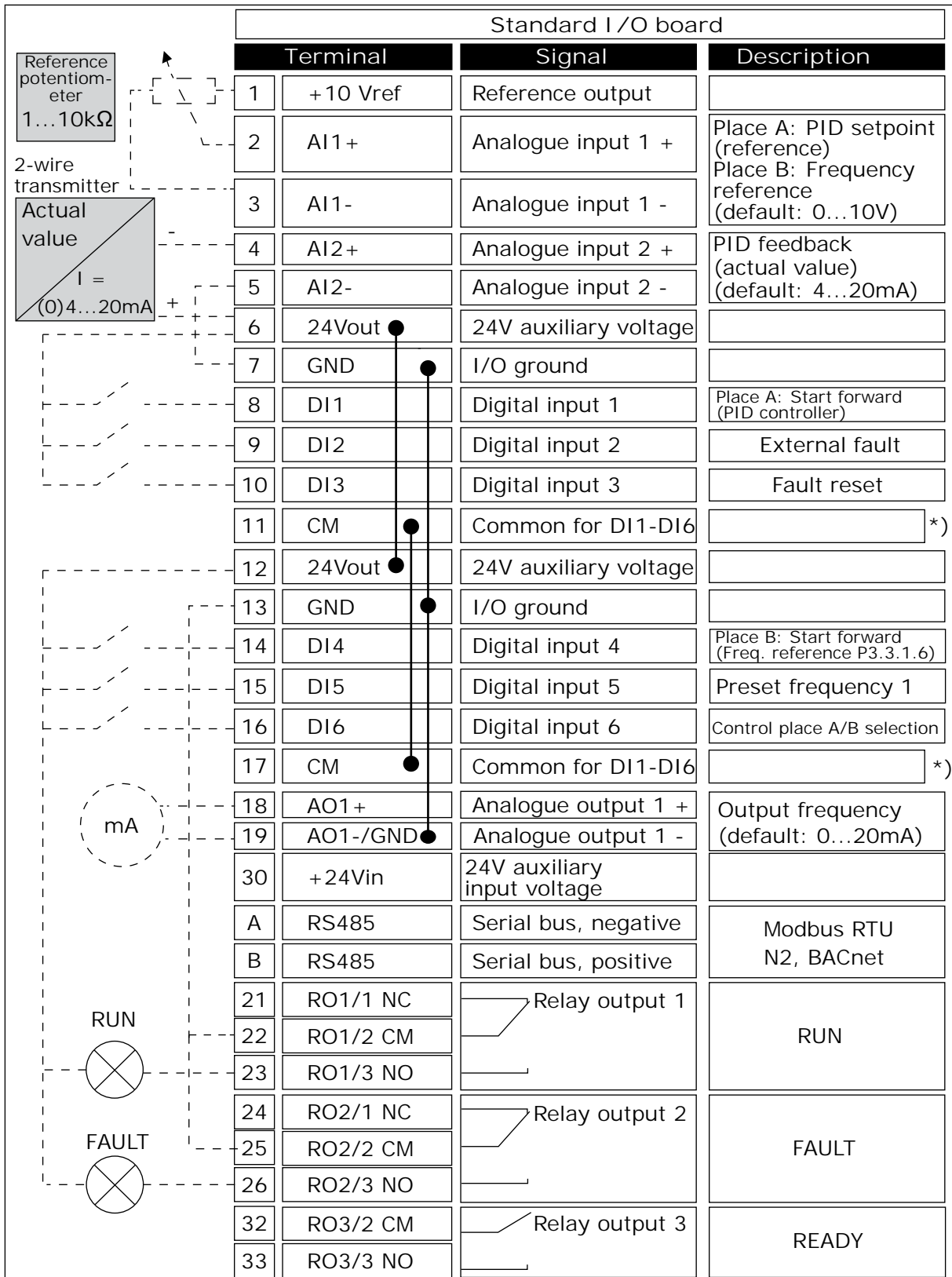

Fig. 10: The default control connections of the PID control application

* = You can isolate the digital inputs from the ground with a DIP switch.

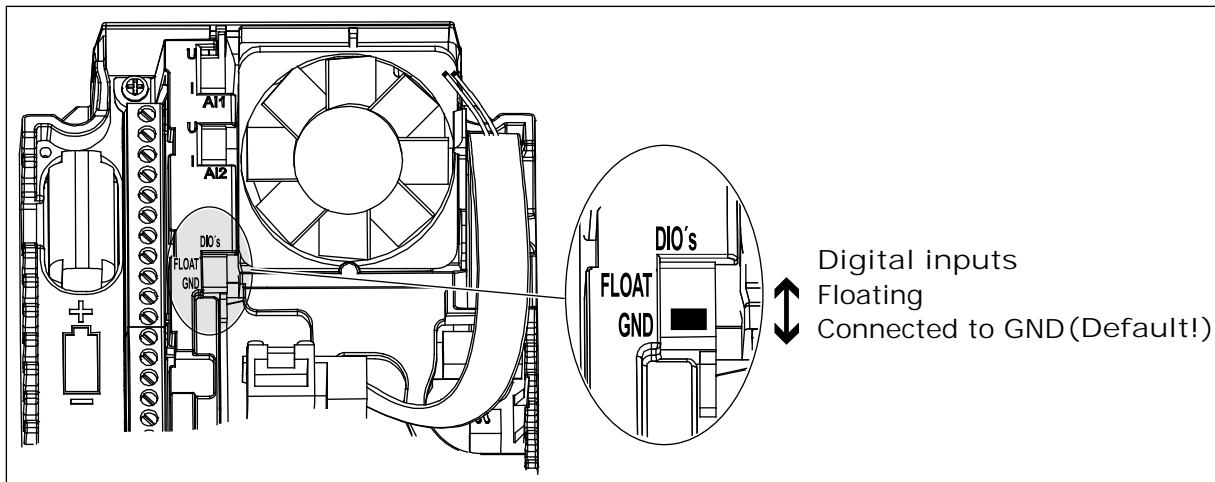

Fig. 11: The DIP switch

Table 11: M1.1 Wizards

Index	Parameter	Min	Max	Unit	Default	ID	Description
1.1.1	Startup wizard	0	1		0	1170	0 = Do not activate 1 = Activate The selection Activate starts the Start-up wizard (see Chapter <i>Table 1 The Start-up wizard</i>).
1.1.3	Multi-pump Wizard	0	1		0	1671	The selection Activate starts the Multipump wizard (see Chapter <i>2.7 Multipump wizard</i>).
1.1.4	Fire mode Wizard	0	1		0	1672	The selection Activate starts the Fire mode wizard (see Chapter <i>2.8 Fire mode wizard</i>).

Table 12: M1 Quick Setup

Index	Parameter	Min	Max	Unit	Default	ID	Description
1.2 	Application	0	5		3	212	0 = Standard 1 = Local/Remote 2 = Multi-Step Speed 3 = PID Control 4 = Multi-Purpose 5 = Motor Potentiometer
1.3	Minimum Frequency Reference	0.00	P1.4	Hz	0.0	101	The minimum frequency reference that is acceptable.
1.4	Maximum Frequency Reference	P1.3	320.0	Hz	50.0 / 60.0	102	The maximum frequency reference that is acceptable.
1.5	Acceleration Time 1	0.1	300.0	s	5.0	103	Gives the quantity of time that is necessary for the output frequency to increase from zero frequency to the maximum frequency.
1.6	Deceleration Time 1	0.1	300.0	s	5.0	104	Gives the quantity of time that is necessary for the output frequency to decrease from the maximum frequency to zero frequency.
1.7	Motor Current Limit	I _H *0.1	I _S	A	Varies	107	The maximum motor current from the AC drive.
1.8	Motor Type	0	1		0	650	0 = Induction Motor 1 = Permanent Magnet Motor
1.9	Motor Nominal Voltage	Varies	Varies	V	Varies	110	Find this value U _n on the rating plate of the motor. NOTE! Find out if the motor connection is Delta or Star.

Table 12: M1 Quick Setup

Index	Parameter	Min	Max	Unit	Default	ID	Description
1.10	Motor Nominal Frequency	8.0	320.0	Hz	50 / 60	111	Find this value f_n on the rating plate of the motor.
1.11	Motor Nominal Speed	24	19200	Rpm	Varies	112	Find this value n_n on the rating plate of the motor.
1.12	Motor Nominal Current	$I_H * 0.1$	$I_H * 2$	A	Varies	113	Find this value I_n on the rating plate of the motor.
1.13	Motor Cos Phi (Power Factor)	0.30	1.00		Varies	120	Find this value on the rating plate of the motor.
1.14	Energy Optimization	0	1		0	666	The drive searches for the minimum motor current to save energy and to lower the motor noise. Use this function with, for example, fan and pump processes. 0 = Disabled 1 = Enabled
1.15	Identification	0	2		0	631	The identification run calculates or measures the motor parameters that are necessary for a good control of the motor and speed. 0 = No action 1 = At standstill 2 = With rotation Before you do the identification run, you must set the motor nameplate parameters.
1.16	Start Function	0	1		0	505	0 = Ramping 1 = Flying Start
1.17	Stop Function	0	1		0	506	0 = Coasting 1 = Ramping

Table 12: M1 Quick Setup

Index	Parameter	Min	Max	Unit	Default	ID	Description
1.18	Automatic Reset	0	1		0	731	0 = Disabled 1 = Enabled
1.19	Response to External Fault	0	3		2	701	0 = No action 1 = Alarm 2 = Fault (Stop according to stop mode) 3 = Fault (Stop by coasting)
1.20	Response to AI Low Fault	0	5		0	700	0 = No action 1 = Alarm 2 = Alarm+preset fault frequency (P3.9.1.13) 3 = Alarm + previous frequency 4 = Fault (Stop according to stop mode) 5 = Fault (Stop by coasting)
1.21	Remote Control Place	0	1		0	172	The selection of the remote control place (start/stop). 0 = I/O control 1 = Fieldbus control

Table 12: M1 Quick Setup

Index	Parameter	Min	Max	Unit	Default	ID	Description
1.22	I/O Control Reference A Selection	0	9		6	117	<p>The selection of the frequency reference source when the control place is I/O A.</p> <p>0 = Preset Frequency 0 1 = Keypad Reference 2 = Fieldbus 3 = AI1 4 = AI2 5 = AI1+AI2 6 = PID Reference 7 = Motor Potentiometer 8 = Joystick Reference 9 = Jogging Reference 10 = Block Out.1 11 = Block Out.2 12 = Block Out.3 13 = Block Out.4 14 = Block Out.5 15 = Block Out.6 16 = Block Out.7 17 = Block Out.8 18 = Block Out.9 19 = Block Out.10</p> <p>The application that you set with parameter 1.2 gives the default value.</p>
1.23	Keypad Control Reference Selection	0	9		1	121	<p>The selection of the frequency reference source when the control place is keypad. See P1.22.</p>
1.24	Fieldbus Control Reference Selection	0	9		2	122	<p>The selection of the frequency reference source when the control place is fieldbus. See P1.22.</p>
1.25	AI1 Signal Range	0	1		0	379	<p>0= 0..10V / 0..20mA 1= 2..10V / 4..20mA</p>
1.26	AI2 Signal Range	0	1		1	390	<p>0= 0..10V / 0..20mA 1= 2..10V / 4..20mA</p>
1.27	R01 Function	0	51		2	1101	See P3.5.3.2.1

Table 12: M1 Quick Setup

Index	Parameter	Min	Max	Unit	Default	ID	Description
1.28	R02 Function	0	51		3	1104	See P3.5.3.2.1
1.29	R03 Function	0	51		1	1107	See P3.5.3.2.1
1.30	A01 Function	0	31		2	10050	See P3.5.4.1.1

Table 13: M1.34 PID control

Index	Parameter	Min	Max	Unit	Default	ID	Description
1.34.1	PID Gain	0.00	100.00	%	100.00	18	If the value of the parameter is set to 100% a change of 10% in the error value causes the controller output to change by 10%.
1.34.2	PID Integration Time	0.00	600.00	s	1.00	119	If this parameter is set to 1,00s a change of 10% in the error value causes the controller output to change by 10.00%/s.
1.34.3	PID Derivation Time	0.00	100.00	s	0.00	1132	If this parameter is set to 1,00s a change of 10% in the error value during 1.00 s causes the controller output to change by 10.00%.
1.34.4	Feedback 1 Source Selection	0	30		2	334	See P3.13.3.3
1.34.5	Setpoint 1 Source Selection	0	32		1	332	See P3.13.2.6
1.34.6	Keypad Setpoint 1	Varies	Varies	Varies	0	167	
1.34.7	Sleep Frequency Limit 1	0.0	320.0	Hz	0.0	1016	Drive goes to sleep mode when the output frequency stays below this limit for a time greater than that defined by parameter Sleep delay.
1.34.8	Sleep Delay 1	0	3000	s	0	1017	The minimum amount of time the frequency has to remain below the Sleep level before the drive is stopped.
1.34.9	Wake-up Level 1	Varies	Varies	Varies	Varies	1018	Defines the level for the PID feedback value wake-up supervision. Uses selected process units.
1.34.10	Preset Frequency 1	P1.3	P1.4	Hz	10.0	105	Preset Frequency selected by digital input DI5.

1.4.5 MULTI-PURPOSE APPLICATION

You can use the Multi-purpose application for different processes (for example conveyors) where a wide range of motor control functions is necessary.

It is possible to control the drive from the keypad, Fieldbus or I/O terminal. When you use I/O terminal control, the start/stop commands are given through DI1 and DI2, and the frequency reference from AI1 or AI2.

There are 2 acceleration/deceleration ramps available. The selection between Ramp1 and Ramp2 is made by DI6.

It is possible to configure all the drive outputs freely in all the applications. There are 1 analogue output (Output Frequency) and 3 relay outputs (Run, Fault, Ready) available on the basic I/O board.

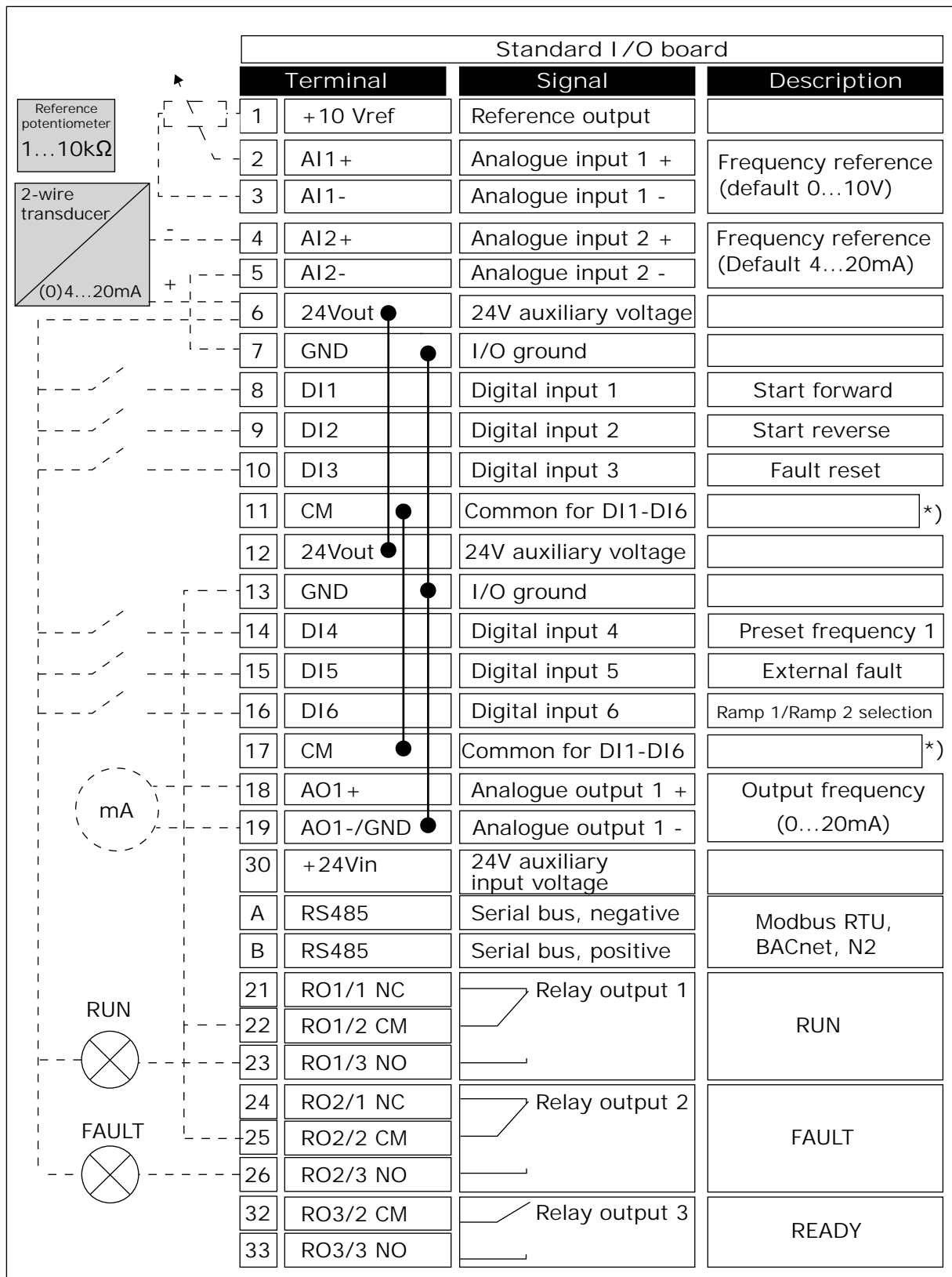

Fig. 12: The default control connections of the Multi-purpose application

* = You can isolate the digital inputs from the ground with a DIP switch.

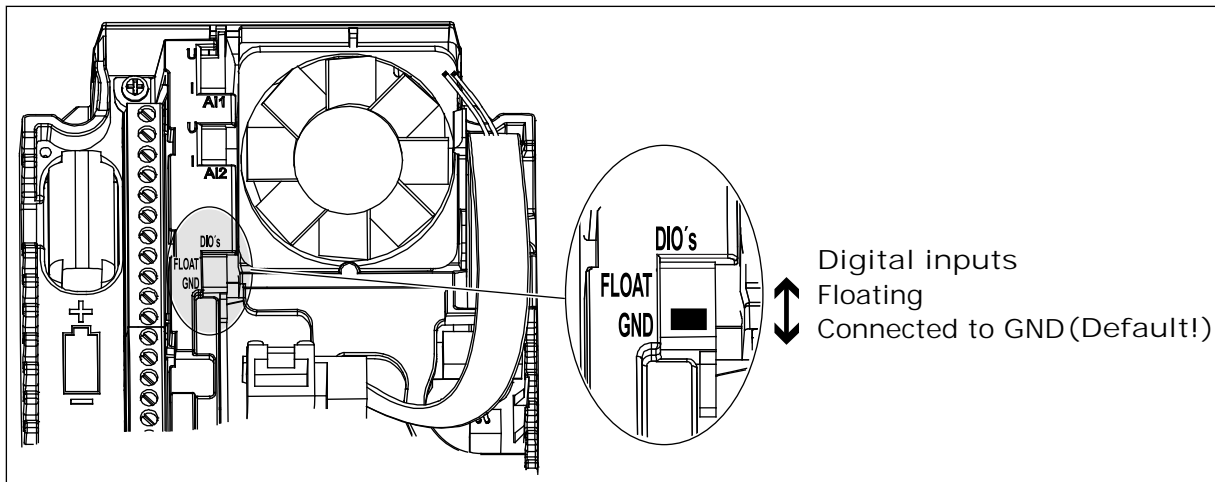

Fig. 13: The DIP switch

Table 14: M1.1 Wizards

Index	Parameter	Min	Max	Unit	Default	ID	Description
1.1.1	Startup wizard	0	1		0	1170	0 = Do not activate 1 = Activate The selection Activate starts the Start-up wizard (see Chapter <i>Table 1 The Start-up wizard</i>).
1.1.3	Multi-pump Wizard	0	1		0	1671	The selection Activate starts the Multipump wizard (see Chapter <i>2.7 Multipump wizard</i>).
1.1.4	Fire mode Wizard	0	1		0	1672	The selection Activate starts the Fire mode wizard (see Chapter <i>2.8 Fire mode wizard</i>).

Table 15: M1 Quick Setup

Index	Parameter	Min	Max	Unit	Default	ID	Description
1.2 	Application	0	5		4	212	0 = Standard 1 = Local/Remote 2 = Multi-Step Speed 3 = PID Control 4 = Multi-Purpose 5 = Motor Potentiometer
1.3	Minimum Frequency Reference	0.00	P1.4	Hz	0.0	101	The minimum frequency reference that is acceptable.
1.4	Maximum Frequency Reference	P1.3	320.0	Hz	50.0 / 60.0	102	The maximum frequency reference that is acceptable.
1.5	Acceleration Time 1	0.1	300.0	s	5.0	103	Gives the quantity of time that is necessary for the output frequency to increase from zero frequency to the maximum frequency.
1.6	Deceleration Time 1	0.1	300.0	s	5.0	104	Gives the quantity of time that is necessary for the output frequency to decrease from the maximum frequency to zero frequency.
1.7	Motor Current Limit	I _H *0.1	I _S	A	Varies	107	The maximum motor current from the AC drive.
1.8	Motor Type	0	1		0	650	0 = Induction Motor 1 = Permanent Magnet Motor
1.9	Motor Nominal Voltage	Varies	Varies	V	Varies	110	Find this value U _n on the rating plate of the motor. NOTE! Find out if the motor connection is Delta or Star.

Table 15: M1 Quick Setup

Index	Parameter	Min	Max	Unit	Default	ID	Description
1.10	Motor Nominal Frequency	8.0	320.0	Hz	50 / 60	111	Find this value f_n on the rating plate of the motor.
1.11	Motor Nominal Speed	24	19200	Rpm	Varies	112	Find this value n_n on the rating plate of the motor.
1.12	Motor Nominal Current	$I_H * 0.1$	$I_H * 2$	A	Varies	113	Find this value I_n on the rating plate of the motor.
1.13	Motor Cos Phi (Power Factor)	0.30	1.00		Varies	120	Find this value on the rating plate of the motor.
1.14	Energy Optimization	0	1		0	666	The drive searches for the minimum motor current to save energy and to lower the motor noise. Use this function with, for example, fan and pump processes. 0 = Disabled 1 = Enabled
1.15	Identification	0	2		0	631	The identification run calculates or measures the motor parameters that are necessary for a good control of the motor and speed. 0 = No action 1 = At standstill 2 = With rotation Before you do the identification run, you must set the motor nameplate parameters.
1.16	Start Function	0	1		0	505	0 = Ramping 1 = Flying Start
1.17	Stop Function	0	1		0	506	0 = Coasting 1 = Ramping

Table 15: M1 Quick Setup

Index	Parameter	Min	Max	Unit	Default	ID	Description
1.18	Automatic Reset	0	1		0	731	0 = Disabled 1 = Enabled
1.19	Response to External Fault	0	3		2	701	0 = No action 1 = Alarm 2 = Fault (Stop according to stop mode) 3 = Fault (Stop by coasting)
1.20	Response to AI Low Fault	0	5		0	700	0 = No action 1 = Alarm 2 = Alarm+preset fault frequency (P3.9.1.13) 3 = Alarm + previous frequency 4 = Fault (Stop according to stop mode) 5 = Fault (Stop by coasting)
1.21	Remote Control Place	0	1		0	172	The selection of the remote control place (start/stop). 0 = I/O control 1 = Fieldbus control

Table 15: M1 Quick Setup

Index	Parameter	Min	Max	Unit	Default	ID	Description
1.22	I/O Control Reference A Selection	0	9		5	117	<p>The selection of the frequency reference source when the control place is I/O A.</p> <p>0 = Preset Frequency 1 = Keypad Reference 2 = Fieldbus 3 = AI1 4 = AI2 5 = AI1+AI2 6 = PID Reference 7 = Motor Potentiometer 8 = Joystick Reference 9 = Jogging Reference 10 = Block Out.1 11 = Block Out.2 12 = Block Out.3 13 = Block Out.4 14 = Block Out.5 15 = Block Out.6 16 = Block Out.7 17 = Block Out.8 18 = Block Out.9 19 = Block Out.10</p> <p>The application that you set with parameter 1.2 gives the default value.</p>
1.23	Keypad Control Reference Selection	0	9		1	121	<p>The selection of the frequency reference source when the control place is keypad. See P1.22.</p>
1.24	Fieldbus Control Reference Selection	0	9		2	122	<p>The selection of the frequency reference source when the control place is fieldbus. See P1.22.</p>
1.25	AI1 Signal Range	0	1		0	379	<p>0= 0..10V / 0..20mA 1= 2..10V / 4..20mA</p>
1.26	AI2 Signal Range	0	1		0	390	<p>0= 0..10V / 0..20mA 1= 2..10V / 4..20mA</p>
1.27	R01 Function	0	51		2	1101	See P3.5.3.2.1

Table 15: M1 Quick Setup

Index	Parameter	Min	Max	Unit	Default	ID	Description
1.28	R02 Function	0	51		3	1104	See P3.5.3.2.1
1.29	R03 Function	0	51		1	1107	See P3.5.3.2.1
1.30	A01 Function	0	31		2	10050	See P3.5.4.1.1

Table 16: M1.35 Multi-purpose

Index	Parameter	Min	Max	Unit	Default	ID	Description
1.35.1	Control Mode	0	2		0	600	0 = U/f Freq Control open loop 1 = Speed control open loop 2 = Torque Control open loop
1.35.2	Auto Torque Boost	0	1		0	109	0 = Disabled 1 = Enabled
1.35.3	Acceleration Time 2	0.1	300.0	s	10.0	502	Defines the time that is necessary for the output frequency to increase from zero frequency to maximum frequency.
1.35.4	Deceleration Time 2	0.1	300.0	s	10.0	503	Defines the time that is necessary for the output frequency to decrease from maximum frequency to zero frequency.
1.35.5	Preset Frequency 1	P1.3	P1.4	Hz	5.0	105	Preset Frequency selected by digital input DI4.
1.35.6	U/f Ratio Select	0	2		0	108	Type of U/f curve between zero frequency and the field weakening point. 0 = Linear 1 = Squared 2 = Programmable
1.35.7	Field Weakening Point Frequency	8.00	P1.4	Hz	Varies	602	The field weakening point is the output frequency at which the output voltage reaches the field weakening point voltage
1.35.8	Voltage at Field Weakening Point	10.00	200.00	%	100.00	603	Voltage at field weakening point in % of motor nominal voltage

Table 16: M1.35 Multi-purpose

Index	Parameter	Min	Max	Unit	Default	ID	Description
1.35.9	U/f Midpoint Frequency	0.0	P1.35.7	Hz	Varies	604	Provided that the programmable U/f curve has been selected (par. P1.35.6), this parameter defines the middle point frequency of the curve.
1.35.10	U/f Midpoint Voltage	0.0	100.00	%	100.0	605	Provided that the programmable U/f curve has been selected (par. P1.35.6), this parameter defines the middle point voltage of the curve.
1.35.11	Zero Frequency Voltage	0.00	40.00	%	Varies	606	This parameter defines the zero frequency voltage of the U/f curve. The default value varies according to unit size.
1.35.12	Start Magnetizing Current	0.00	Varies	A	Varies	517	Defines the DC current fed into motor at start. Disabled if set to 0.
1.35.13	Start Magnetizing Time	0.00	600.00	s	0.00	516	This parameter defines the time for how long DC current is fed to motor before acceleration starts.
1.35.14	DC Brake Current	Varies	Varies	A	Varies	507	Defines the current injected into the motor during DC braking. 0 = Disabled
1.35.15	DC Braking time at stop	0.00	600.00	s	0.00	508	Determines if braking is ON or OFF and the braking time of the DC-brake when the motor is stopping.
1.35.16	Frequency to start DC braking at ramp stop	0.10	50.00	%	0.00	515	The output frequency at which the DC-braking is applied.

Table 16: M1.35 Multi-purpose

Index	Parameter	Min	Max	Unit	Default	ID	Description
1.35.17	Load Drooping	0.00	50.00	%	0.00	620	The drooping function enables speed drop as a function of load. Drooping will be defined in percent of nominal speed at nominal load.
1.35.18	Load Drooping Time	0.00	2.00	s	0.00	656	Load drooping is used in order to achieve a dynamic speed drooping because of changing load. This parameter defines the time during which the speed is restored to the level it was before the load increase.
1.35.19	Load Drooping Mode	0	1		0	1534	0 = Normal; Load drooping factor is constant through the whole frequency range 1 = Linear removal; Load drooping is removed linearly from nominal frequency to zero frequency

1.4.6 MOTOR POTENTIOMETER APPLICATION

Use the Motor potentiometer application for the processes where the frequency reference of the motor is controlled (that is, increased and decreased) through digital inputs.

In this application, the I/O terminal is set to the default control place. The start/stop commands are given with DI1 and DI2. The frequency reference of the motor is increased with DI5 and decreased with DI6.

It is possible to configure all the drive outputs freely in all the applications. There are 1 analogue output (Output Frequency) and 3 relay outputs (Run, Fault, Ready) available on the basic I/O board.

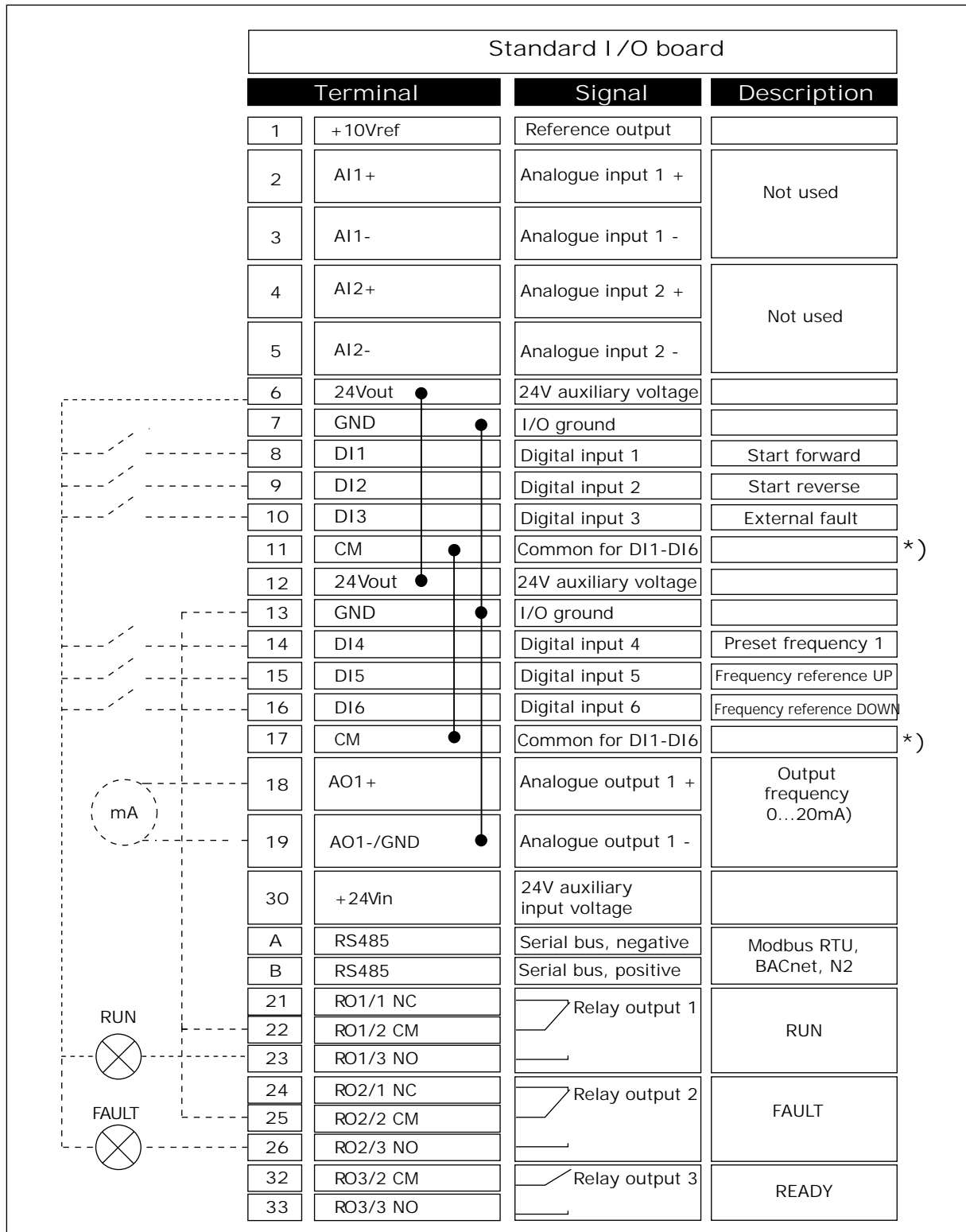

Fig. 14: The default control connections of the Motor potentiometer application

* = You can isolate the digital inputs from the ground with a DIP switch.

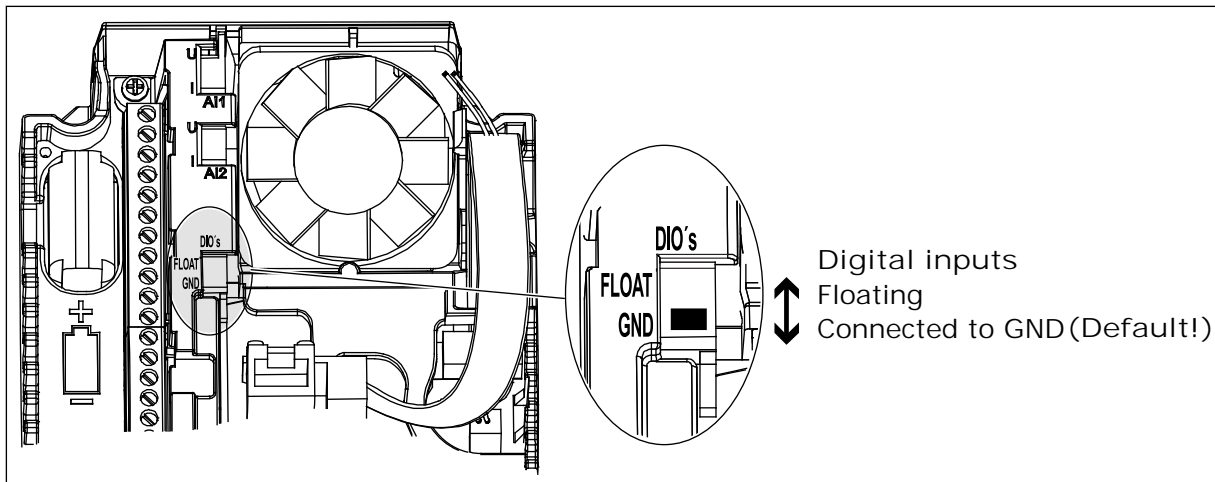

Fig. 15: The DIP switch

Table 17: M1.1 Wizards

Index	Parameter	Min	Max	Unit	Default	ID	Description
1.1.1	Startup wizard	0	1		0	1170	0 = Do not activate 1 = Activate The selection Activate starts the Start-up wizard (see Chapter <i>Table 1 The Start-up wizard</i>).
1.1.3	Multi-pump Wizard	0	1		0	1671	The selection Activate starts the Multipump wizard (see Chapter <i>2.7 Multipump wizard</i>).
1.1.4	Fire mode Wizard	0	1		0	1672	The selection Activate starts the Fire mode wizard (see Chapter <i>2.8 Fire mode wizard</i>).

Table 18: M1 Quick Setup

Index	Parameter	Min	Max	Unit	Default	ID	Description
1.2 	Application	0	5		5	212	0 = Standard 1 = Local/Remote 2 = Multi-Step Speed 3 = PID Control 4 = Multi-Purpose 5 = Motor Potentiometer
1.3	Minimum Frequency Reference	0.00	P1.4	Hz	0.0	101	The minimum frequency reference that is acceptable.
1.4	Maximum Frequency Reference	P1.3	320.0	Hz	50.0 / 60.0	102	The maximum frequency reference that is acceptable.
1.5	Acceleration Time 1	0.1	300.0	s	5.0	103	Gives the quantity of time that is necessary for the output frequency to increase from zero frequency to the maximum frequency.
1.6	Deceleration Time 1	0.1	300.0	s	5.0	104	Gives the quantity of time that is necessary for the output frequency to decrease from the maximum frequency to zero frequency.
1.7	Motor Current Limit	I _H *0.1	I _S	A	Varies	107	The maximum motor current from the AC drive.
1.8	Motor Type	0	1		0	650	0 = Induction Motor 1 = Permanent Magnet Motor
1.9	Motor Nominal Voltage	Varies	Varies	V	Varies	110	Find this value U _n on the rating plate of the motor. NOTE! Find out if the motor connection is Delta or Star.

Table 18: M1 Quick Setup

Index	Parameter	Min	Max	Unit	Default	ID	Description
1.10	Motor Nominal Frequency	8.0	320.0	Hz	50 / 60	111	Find this value f_n on the rating plate of the motor.
1.11	Motor Nominal Speed	24	19200	Rpm	Varies	112	Find this value n_n on the rating plate of the motor.
1.12	Motor Nominal Current	$I_H * 0.1$	$I_H * 2$	A	Varies	113	Find this value I_n on the rating plate of the motor.
1.13	Motor Cos Phi (Power Factor)	0.30	1.00		Varies	120	Find this value on the rating plate of the motor.
1.14	Energy Optimization	0	1		0	666	The drive searches for the minimum motor current to save energy and to lower the motor noise. Use this function with, for example, fan and pump processes. 0 = Disabled 1 = Enabled
1.15	Identification	0	2		0	631	The identification run calculates or measures the motor parameters that are necessary for a good control of the motor and speed. 0 = No action 1 = At standstill 2 = With rotation Before you do the identification run, you must set the motor nameplate parameters.
1.16	Start Function	0	1		0	505	0 = Ramping 1 = Flying Start
1.17	Stop Function	0	1		0	506	0 = Coasting 1 = Ramping

Table 18: M1 Quick Setup

Index	Parameter	Min	Max	Unit	Default	ID	Description
1.18	Automatic Reset	0	1		0	731	0 = Disabled 1 = Enabled
1.19	Response to External Fault	0	3		2	701	0 = No action 1 = Alarm 2 = Fault (Stop according to stop mode) 3 = Fault (Stop by coasting)
1.20	Response to AI Low Fault	0	5		0	700	0 = No action 1 = Alarm 2 = Alarm+preset fault frequency (P3.9.1.13) 3 = Alarm + previous frequency 4 = Fault (Stop according to stop mode) 5 = Fault (Stop by coasting)
1.21	Remote Control Place	0	1		0	172	The selection of the remote control place (start/stop). 0 = I/O control 1 = Fieldbus control

Table 18: M1 Quick Setup

Index	Parameter	Min	Max	Unit	Default	ID	Description
1.22	I/O Control Reference A Selection	0	9		7	117	<p>The selection of the frequency reference source when the control place is I/O A.</p> <p>0 = Preset Frequency 1 = Keypad Reference 2 = Fieldbus 3 = AI1 4 = AI2 5 = AI1+AI2 6 = PID Reference 7 = Motor Potentiometer 8 = Joystick Reference 9 = Jogging Reference 10 = Block Out.1 11 = Block Out.2 12 = Block Out.3 13 = Block Out.4 14 = Block Out.5 15 = Block Out.6 16 = Block Out.7 17 = Block Out.8 18 = Block Out.9 19 = Block Out.10</p> <p>The application that you set with parameter 1.2 gives the default value.</p>
1.23	Keypad Control Reference Selection	0	9		1	121	<p>The selection of the frequency reference source when the control place is keypad. See P1.22.</p>
1.24	Fieldbus Control Reference Selection	0	9		2	122	<p>The selection of the frequency reference source when the control place is fieldbus. See P1.22.</p>
1.25	AI1 Signal Range	0	1		0	379	<p>0= 0..10V / 0..20mA 1= 2..10V / 4..20mA</p>
1.26	AI2 Signal Range	0	1		1	390	<p>0= 0..10V / 0..20mA 1= 2..10V / 4..20mA</p>
1.27	R01 Function	0	51		2	1101	See P3.5.3.2.1

Table 18: M1 Quick Setup

Index	Parameter	Min	Max	Unit	Default	ID	Description
1.28	R02 Function	0	51		3	1104	See P3.5.3.2.1
1.29	R03 Function	0	51		1	1107	See P3.5.3.2.1
1.30	A01 Function	0	31		2	10050	See P3.5.4.1.1

Table 19: M1.36 Motor Potentiometer

Index	Parameter	Min	Max	Unit	Default	ID	Description
1.36.1	Motor Potentiometer Ramp Time	0.1	500.0	Hs/s	10.0	331	The rate of change in the motor potentiometer reference when it is increased or decreased with DI5 or DI6.
1.31.2	Motor Potentiometer Reset	0	2		1	367	The condition in which the frequency reference of the motor potentiometer is reset to zero. 0 = No reset 1 = Reset if stopped 2 = Reset if powered down
1.31.2	Preset Frequency 1	P1.3	P1.4	Hz	10.0	105	Make the selection of a preset frequency with the digital input DI4.

2 WIZARDS

2.1 STANDARD APPLICATION WIZARD

The application wizard helps you to set the basic parameters that are related to the application.

To start the Standard application wizard, set the value *Standard* to parameter P1.2 Application (ID 212) in the keypad.



NOTE!

If you start the application wizard from the Start-up wizard, the wizard goes directly to question 11.

1	Set a value for P3.1.2.2 Motor Type (so that it agrees with the nameplate of the motor)	PM motor Induction motor
2	Set a value for P3.1.1.1 Motor Nominal Voltage (so that it agrees with the nameplate of the motor)	Range: Varies
3	Set a value for P3.1.1.2 Motor Nominal Frequency (so that it agrees with the nameplate of the motor)	Range: 8.00...320.00 Hz
4	Set a value for P3.1.1.3 Motor Nominal Speed (so that it agrees with the nameplate of the motor)	Range: 24...19200 rpm
5	Set a value for P3.1.1.4 Motor Nominal Current (so that it agrees with the nameplate of the motor)	Range: Varies

If you set Motor Type to *Induction Motor*, you see the next question. If your selection is *PM Motor*, the value of parameter P3.1.1.5 Motor Cos Phi is set to 1.00, and the wizard goes directly to question 7.

6	Set a value for P3.3.1.5 Motor Cos Phi (so that it agrees with the nameplate of the motor)	Range: 0.3...1.00
7	Set a value for P3.3.1.1 Minimum Frequency Reference	Range: 0.00...P3.3.1.2 Hz
8	Set a value for P3.3.1.1 Maximum Frequency Reference	Range: P3.3.1.1...320.00 Hz
9	Set a value for P3.4.1.2 Acceleration Time 1	Range: 0.1...300.0 s
10	Set a value for P3.4.1.2 Deceleration Time 1	Range: 0.1...300.0 s
11	Make a selection of a control place (where you give the start and stop commands, and the frequency reference of the drive)	I/O terminal Fieldbus Keypad

The Standard application wizard is completed.

2.2 LOCAL/REMOTE APPLICATION WIZARD

The application wizard helps you to set the application related basic parameters.

To start the Local/Remote application wizard, set the value *Local/Remote* to parameter P1.2 Application (ID 212) in the keypad.



NOTE!

If you start the application wizard from the Start-up wizard, the wizard goes directly to question 11.

1	Set a value for P3.1.2.2 Motor Type (so that it agrees with the nameplate of the motor)	PM motor Induction motor
2	Set a value for P3.1.1.1 Motor Nominal Voltage (so that it agrees with the nameplate of the motor)	Range: Varies
3	Set a value for P3.1.1.2 Motor Nominal Frequency (so that it agrees with the nameplate of the motor)	Range: 8.00...320.00 Hz
4	Set a value for P3.1.1.3 Motor Nominal Speed (so that it agrees with the nameplate of the motor)	Range: 24...19200 rpm
5	Set a value for P3.1.1.4 Motor Nominal Current (so that it agrees with the nameplate of the motor)	Range: Varies

If you set Motor Type to *Induction Motor*, you see the next question. If your selection is *PM Motor*, the value of parameter P3.1.1.5 Motor Cos Phi is set to 1.00, and the wizard goes directly to question 7.

6	Set a value for P3.1.1.5 Motor Cos Phi (so that it agrees with the nameplate of the motor)	Range: 0.30...1.00
7	Set a value for P3.3.1.1 Minimum Frequency Reference	Range: 0.00...P3.3.1.2 Hz
8	Set a value for P3.3.1.2 Maximum Frequency Reference	Range: P3.3.1.1...320.00 Hz
9	Set a value for P3.4.1.2 Acceleration Time 1	Range: 0.1...300.0 s
10	Set a value for P3.4.1.3 Deceleration Time 1	Range: 0.1...300.0 s
11	Make a selection of the Remote control place (where you give the start and stop commands, and the frequency reference of the drive when Remote control is active)	I/O terminal Fieldbus

If you set *I/O Terminal* as the value for Remote Control Place, you see the next question. If you set *Fieldbus*, the wizard goes directly to question 14.

12	P1.26 Analogue Input 2 Signal Range	0=0...10V / 0...20mA 1=2...10V / 4...20mA
13	Set Local Control Place (where the drive start/stop commands and the frequency reference is given when Local control is active)	Fieldbus Keypad I/O (B) terminal

If you set *I/O (B) Terminal* as the value for Local Control Place, you see the next question. With other selections, the wizard goes directly to question 16.

14	P1.25 Analogue Input 1 Signal Range	0=0...10V / 0...20mA 1=2...10V / 4...20mA
----	-------------------------------------	--

The Local/Remote application wizard is completed.

2.3 MULTI-STEP SPEED APPLICATION WIZARD

The application wizard helps you to set the basic parameters that are related to the application.

To start the Multi-step speed application wizard, set the value *Multi-step speed* to parameter P1.2 Application (ID 212) in the keypad.



NOTE!

If you start the application wizard from the Start-up wizard, the wizard shows only the I/O configuration.

1	Set a value for P3.1.2.2 Motor Type (so that it agrees with the nameplate of the motor)	PM motor Induction motor
2	Set a value for P3.1.1.1 Motor Nominal Voltage (so that it agrees with the nameplate of the motor)	Range: Varies
3	Set a value for P3.1.1.2 Motor Nominal Frequency (so that it agrees with the nameplate of the motor)	Range: 8.00...320.00 Hz
4	Set a value for P3.1.1.3 Motor Nominal Speed (so that it agrees with the nameplate of the motor)	Range: 24...19200 rpm
5	Set a value for P3.1.1.4 Motor Nominal Current (so that it agrees with the nameplate of the motor)	Range: Varies

If you set Motor Type to *Induction Motor*, you see the next question. If your selection is *PM Motor*, the value of parameter P3.1.1.5 Motor Cos Phi is set to 1.00, and the wizard goes directly to question 7.

6	Set a value for P3.1.1.5 Motor Cos Phi (so that it agrees with the nameplate of the motor)	Range: 0.30...1.00
7	Set a value for P3.3.1.1 Minimum Frequency Reference	Range: 0.00...P3.3.1.2 Hz
8	Set a value for P3.3.1.2 Maximum Frequency Reference	Range: P3.3.1.1...320.00 Hz
9	Set a value for P3.4.1.2 Acceleration Time 1	Range: 0.1...300.0 s
10	Set a value for P3.4.1.3 Deceleration Time 1	Range: 0.1...300.0 s

The Multi-step speed application wizard is completed.

2.4 PID CONTROL APPLICATION WIZARD

The application wizard helps you to set the basic parameters that are related to the application.

To start the PID control application wizard, set the value *PID control* to parameter P1.2 Application (ID 212) in the keypad.



NOTE!

If you start the application wizard from the startup wizard, the wizard goes directly to the question 11.

1	Set a value for P3.1.2.2 Motor Type (so that it agrees with the nameplate of the motor)	PM motor Induction motor
2	Set a value for P3.1.1.1 Motor Nominal Voltage (so that it agrees with the nameplate of the motor)	Range: Varies
3	Set a value for P3.1.1.2 Motor Nominal Frequency (so that it agrees with the nameplate of the motor)	Range: 8.00...320.00 Hz
4	Set a value for P3.1.1.3 Motor Nominal Speed (so that it agrees with the nameplate of the motor)	Range: 24...19200 rpm
5	Set a value for P3.1.1.4 Motor Nominal Current (so that it agrees with the nameplate of the motor)	Range: Varies

If you set Motor Type to *Induction Motor*, you see the next question. If your selection is *PM Motor*, the value of parameter P3.1.1.5 Motor Cos Phi is set to 1.00, and the wizard goes directly to question 7.

6	Set a value for P3.1.1.5 Motor Cos Phi (so that it agrees with the nameplate of the motor)	Range: 0.30...1.00
7	Set a value for P3.3.1.1 Minimum Frequency Reference	Range: 0.00 Hz...P3.3.1.2
8	Set a value for P3.3.1.2 Maximum Frequency Reference	Range: P3.3.1.1...320.00 Hz
9	Set a value for P3.4.1.2 Acceleration Time 1	Range: 0.1...300.0 s
10	Set a value for P3.4.1.3 Deceleration Time 1	Range: 0.1...300.0 s
11	Make a selection of a control place (where you give the start/stop commands)	I/O Terminal Fieldbus Keypad
12	Set a value for P3.13.1.4 Process Unit Selection	More than 1 selection

If your selection is other than %, you see the next questions. If your selection is %, the wizard goes directly to question 17.

13	Set a value for P3.13.1.5 Process Unit Min	The range depends on the selection in question 12.
14	Set a value for P3.13.1.6 Process Unit Max	The range depends on the selection in question 12.
15	Set a value for P3.13.1.7 Process Unit Decimals	Range: 0...4
16	Set a value for P3.13.3.3 Feedback 1 Source Selection	See the table Feedback settings in Chapter 5.13 Group 3.13: PID controller

If you make a selection of an analogue input signal, you see the question 18. With other selections, the wizard goes to question 19.

17	Set the signal range of the analogue input	0 = 0...10V / 0...20mA 1 = 2...10V / 4...20mA
18	Set a value for P3.13.1.8 Error Inversion	0 = Normal 1 = Inverted
19	Set a value for P3.13.2.6 Setpoint Source Selection	See table Setpoints in Chapter 5.13 Group 3.13: PID controller

If you make a selection of an analogue input signal, you see the question 21. With other selections, the wizard goes to question 23.

If you set *Keypad Setpoint 1* or *Keypad Setpoint 2* for the value, the wizard goes directly to question 22.

20	Set the signal range of the analogue input	0 = 0...10V / 0...20mA 1 = 2...10V / 4...20mA
21	Set a value for P3.13.2.1 (Keypad Setpoint 1) and P3.13.2.2 (Keypad Setpoint 2)	Depends on the range set in the question 20.
22	Using the sleep function	0 = No 1 = Yes

If you give the value *Yes* for the question 22, you see the next 3 questions. If you give the value *No*, the wizard is completed.

23	Set a value for P3.34.7 Sleep Frequency Limit	Range: 0.00...320.00 Hz
24	Set a value for P3.34.8 Sleep Delay 1	Range: 0...3000 s
25	Set a value for P3.34.9 Wake-up Level	The range depends on the set process unit

The PID Control application wizard is completed.

2.5 MULTI-PURPOSE APPLICATION WIZARD

The application wizard helps you to set the basic parameters that are related to the application.

To start the Multi-purpose application wizard, set the value *Multi-purpose* to parameter P1.2 Application (ID 212) in the keypad.



NOTE!

If you start the application wizard from the Start-up wizard, the wizard goes directly to question 11.

1	Set a value for P3.1.2.2 Motor Type (so that it agrees with the nameplate of the motor)	PM motor Induction motor
2	Set a value for P3.1.1.1 Motor Nominal Voltage (so that it agrees with the nameplate of the motor)	Range: Varies
3	Set a value for P3.1.1.2 Motor Nominal Frequency (so that it agrees with the nameplate of the motor)	Range: 8.00...320.00 Hz
4	Set a value for P3.1.1.3 Motor Nominal Speed (so that it agrees with the nameplate of the motor)	Range: 24...19200 rpm
5	Set a value for P3.1.1.4 Motor Nominal Current (so that it agrees with the nameplate of the motor)	Range: Varies

If you set Motor Type to *Induction Motor*, you see the next question. If your selection is *PM Motor*, the value of parameter P3.1.1.5 Motor Cos Phi is set to 1.00, and the wizard goes directly to question 7.

6	Set a value for P3.1.1.5 Motor Cos Phi (so that it agrees with the nameplate of the motor)	Range: 0.30...1.00
7	Set a value for P3.3.1.1 Minimum Frequency Reference	Range: 0.00...P3.3.1.2 Hz
8	Set a value for P3.3.1.2 Maximum Frequency Reference	Range: P3.3.1.1...320.00 Hz
9	Set a value for P3.4.1.2 Acceleration Time 1	Range: 0.1...300.0 s
10	Set a value for P3.4.1.3 Deceleration Time 1	Range: 0.1...300.0 s
11	Select Control Place (where you give the start and stop commands, and the frequency reference of the drive)	I/O Terminal Fieldbus Keypad

The Multi-purpose application wizard is completed.

2.6 MOTOR POTENTIOMETER APPLICATION WIZARD

The application wizard helps you to set the application related basic parameters.

To start the Motor potentiometer application wizard, set the value *Motor potentiometer* to parameter P1.2 Application (ID 212) in the keypad.



NOTE!

If you start the application wizard from the Start-up wizard, the wizard goes directly to question 11.

1	Set a value for P3.1.2.2 Motor Type (so that it agrees with the nameplate of the motor)	PM motor Induction motor
2	Set a value for P3.1.1.1 Motor Nominal Voltage (so that it agrees with the nameplate of the motor)	Range: Varies
3	Set a value for P3.1.1.2 Motor Nominal Frequency (so that it agrees with the nameplate of the motor)	Range: 8.00...320.00 Hz
4	Set a value for P3.1.1.3 Motor Nominal Speed (so that it agrees with the nameplate of the motor)	Range: 24...19200 rpm
5	Set a value for P3.1.1.4 Motor Nominal Current (so that it agrees with the nameplate of the motor)	Range: Varies

If you set Motor Type to *Induction Motor*, you see the next question. If your selection is *PM Motor*, the value of parameter P3.1.1.5 Motor Cos Phi is set to 1.00, and the wizard goes directly to question 7.

6	Set a value for P3.1.1.5 Motor Cos Phi (so that it agrees with the nameplate of the motor)	Range: 0.30...1.00
7	Set a value for P3.3.1.1 Minimum Frequency Reference	Range: 0.00...P3.3.1.2 Hz
8	Set a value for P3.3.1.2 Maximum Frequency Reference	Range: P3.3.1.1...320.00 Hz
9	Set a value for P3.4.1.2 Acceleration Time 1	Range: 0.1...300.0 s
10	Set a value for P3.4.1.3 Deceleration Time 1	Range: 0.1...300.0 s
11	Set a value for P1.36.1 Motor Potentiometer Ramp Time	Range: 0.1...500.0 Hz/s
12	Set a value for P1.36.2 Motor Potentiometer Reset	0 = No Reset 1 = Stop State 2 = Power Down

The Motor Potentiometer application wizard is completed.

2.7 MULTIPUMP WIZARD

To start the Multipump wizard, make the selection *Activate* for parameter B1.1.3 in the Quick setup menu. The default settings tell you to use the PID controller in the one feedback / one setpoint mode. The default control place is I/O A, and the default process unit is %.

1	Set a value for P3.13.1.4 Process Unit Selection	More than 1 selection.
---	--	------------------------

If your selection is other than %, you see the next questions. If your selection is %, the wizard goes directly to question 5.

2	Set a value for P3.13.1.5 Process Unit Min	Varies
3	Set a value for P3.13.1.6 Process Unit Max	Varies
4	Set a value for P3.13.1.7 Process Unit Decimals	0..4
5	Set a value for P3.13.3.3 Feedback 1 Source Selection	See the table Feedback settings in Chapter 5.13 Group 3.13: PID controller.

If you make a selection of an analogue input signal, you see the question 6. With other selections, the wizard goes to question 7.

6	Set the signal range of the analogue input	0 = 0...10V / 0...20mA 1 = 2...10V / 4...20mA See table Analogue inputs in Chapter 5.5 <i>Group 3.5: I/O configuration.</i>
7	Set a value for P3.13.1.8 Error Inversion	0 = Normal 1 = Inverted
8	Set a value for P3.13.2.6 Setpoint Source 1 Selection	See table Setpoints in Chapter 5.13 <i>Group 3.13: PID controller.</i>

If you make a selection of an analogue input signal, you see the question 9. With other selections, the wizard goes to question 11.

If you set *Keypad Setpoint 1* or *Keypad Setpoint 2* for the value, you see the question 10.

9	Set the signal range of the analogue input	0 = 0...10V / 0...20mA 1 = 2...10V / 4...20mA See table Analogue inputs in Chapter 5.5 <i>Group 3.5: I/O configuration.</i>
10	Set a value for P3.13.2.1 (Keypad setpoint 1) and P3.13.2.2 (Keypad setpoint 2)	Varies
11	Using the sleep function	No Yes

If you give the value *Yes* for the question 11, you see the next 3 questions.

12	Set a value for P3.13.5.1 Sleep Frequency Limit 1	0.00...320.00 Hz
13	Set a value for P3.13.5.2 Sleep Delay 1	0...3000 s
14	Set a value for P3.13.5.6 Wake-up Level 1	The range depends on the set process unit.
15	Set a value for P3.15.1 Number of Motors	1...6
16	Set a value for P3.15.2 Interlock Function	0 = Not used 1 = Enabled
17	Set a value for P3.15.4 Autochange	0 = Disabled 1 = Enabled

If you enable the Autochange function, you see the next 3 questions. If you do not use the Autochange function, the wizard goes directly to question 21.

18	Set a value for P3.15.3 Include FC	0 = Disabled 1 = Enabled
19	Set a value for P3.15.5 Autochange Interval	0.0...3000.0 h
20	Set a value for P3.15.6 Autochange: Frequency Limit	0.00...50.00 Hz
21	Set a value for P3.15.8 Bandwidth	0...100%
22	Set a value for P3.15.9 Bandwidth Delay	0...3600 s

After this, the display will show the digital input and relay output configuration that the application does automatically. Write these values down. This function is not available in the text display.

2.8 FIRE MODE WIZARD

To start the Fire Mode Wizard, make the selection *Activate* for parameter B1.1.4 in the Quick setup menu.



CAUTION!

Before you continue, read about the password and warranty in Chapter 9.15 *Fire mode*.

1	Set a value for parameter P3.17.2 Fire Mode Frequency Source	More than 1 selection
---	--	-----------------------

If you set a value other than *Fire mode frequency*, the wizard goes directly to question 3.

2	Set a value for parameter P3.17.3 Fire Mode Frequency	8.00 Hz...P3.3.1.2 (MaxFreqRef)
3	Activate the signal when the contact opens or when it closes	0 = Open contact 1 = Closed contact
4	Set a value for parameters P3.17.4 Fire Mode Activation on OPEN / P3.17.5 Fire Mode Activation on CLOSE	Make a selection of a digital input to activate Fire mode. See also Chapter 9.7.1 <i>Programming of digital and analogue inputs.</i>
5	Set a value for parameter P3.17.6 Fire Mode Reverse	Make a selection of a digital input to activate the reverse direction in Fire mode. DigIn Slot0.1 = FORWARD DigIn Slot0.2 = REVERSE
6	Set a value for P3.17.1 Fire Mode Password	Set a password to enable the Fire mode function. 1234 = Enable test mode 1002 = Enable Fire mode

3 USER INTERFACES

3.1 NAVIGATION ON THE KEYPAD

The data of the AC drive is in menus and submenus. To move between the menus, use the arrow buttons Up and Down in the keypad. To go into a group or an item, push the OK button. To go back to the level where you were before, push the Back/Reset button.

On the display, you see your current location in the menu, for example M3.2.1. You also see the name of the group or item in your current location.

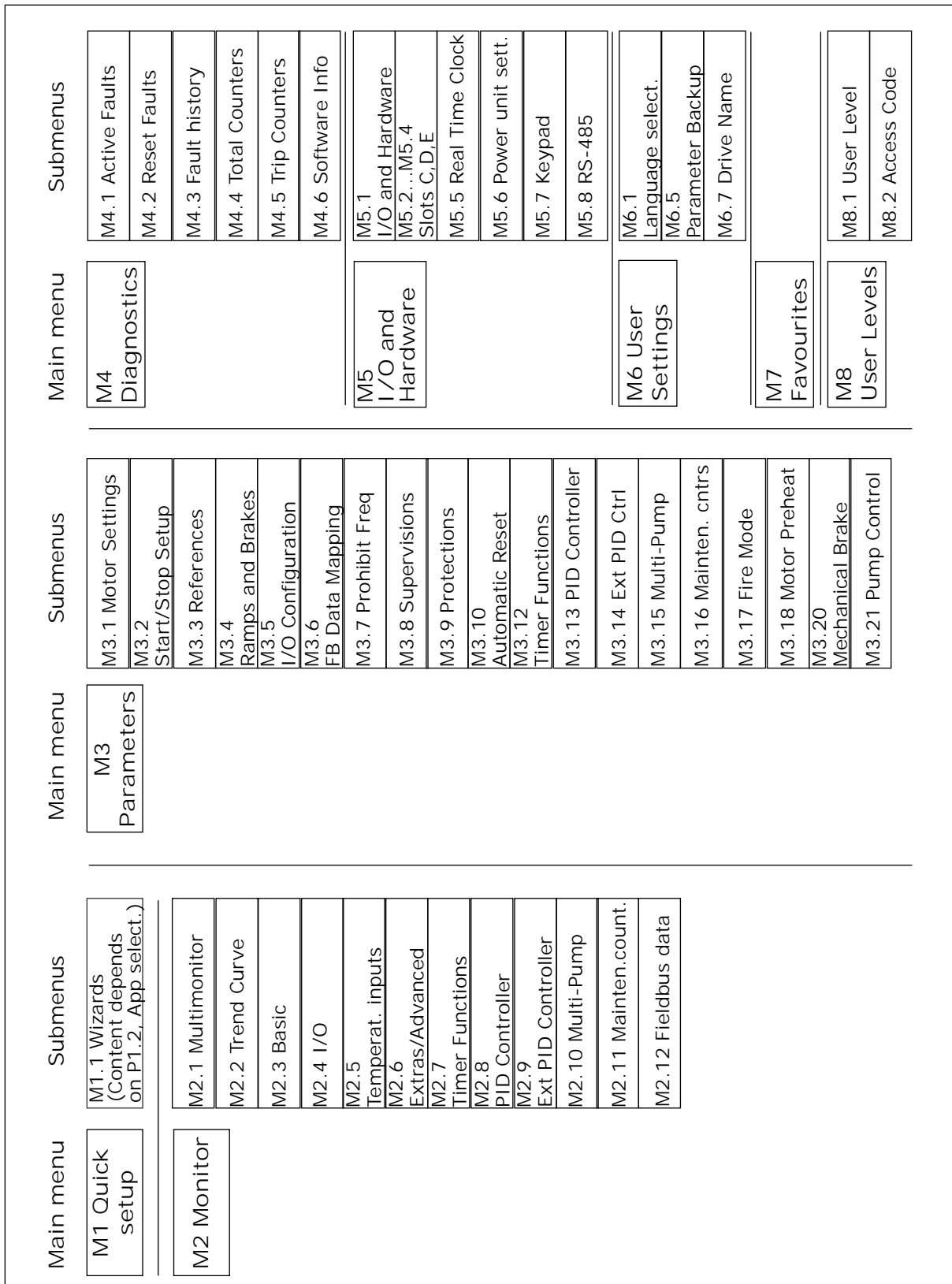

Fig. 16: The basic menu structure of the AC drive

3.2 USING THE GRAPHICAL DISPLAY

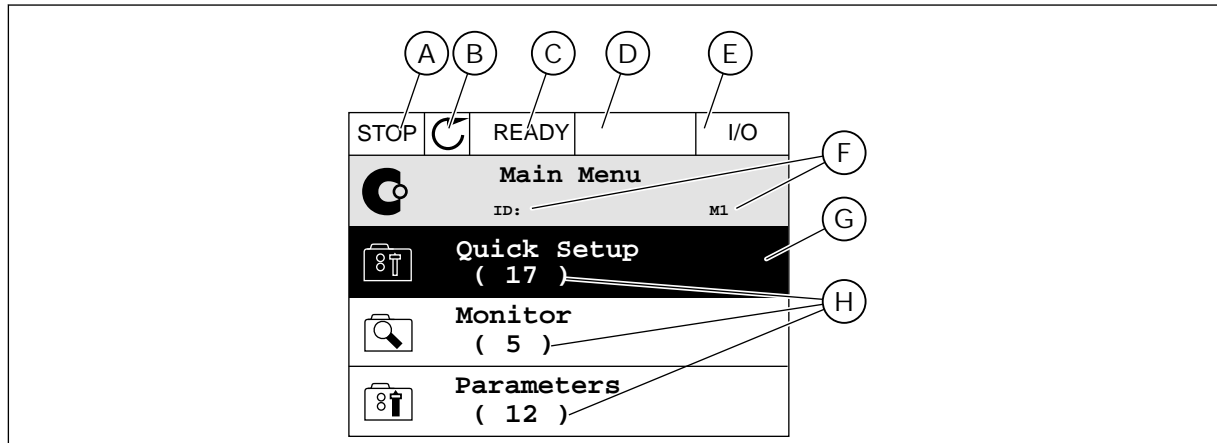

Fig. 17: The main menu of the graphical display

- A. The first status field: STOP/RUN
- B. The rotation direction
- C. The second status field: READY/NOT READY/FAULT
- D. The alarm field: ALARM/-
- E. The control place: PC/IO/KEYPAD/ FIELDBUS
- F. The location field: the parameter ID number and the current location in the menu
- G. An activated group or item: push OK to go in
- H. The number of items in the group in question

3.2.1 EDITING THE VALUES

On the graphical display, there are 2 different procedures to edit the value of an item.

Usually, you can set only 1 value for a parameter. Make a selection from a list of text values or from a range of numerical values.

CHANGING THE TEXT VALUE OF A PARAMETER

- 1 Find the parameter.

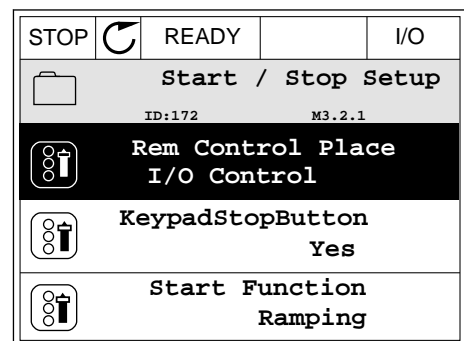

- To go to the Edit mode, push the OK button 2 times or push the arrow button Right.

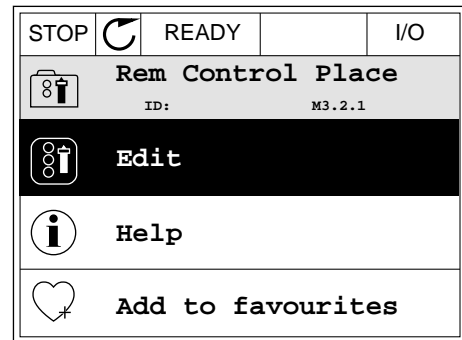

- To set a new value, push the arrow buttons Up and Down.

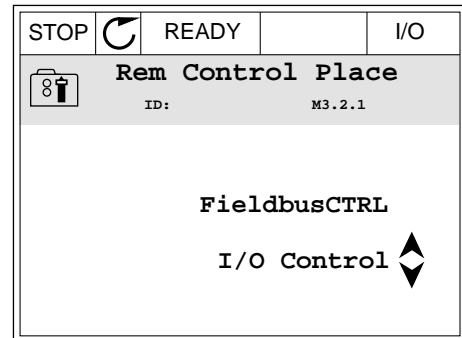

- To accept the change, push the OK button. To ignore the change, use the Back/Reset button.

EDITING THE NUMERICAL VALUES

- Find the parameter.

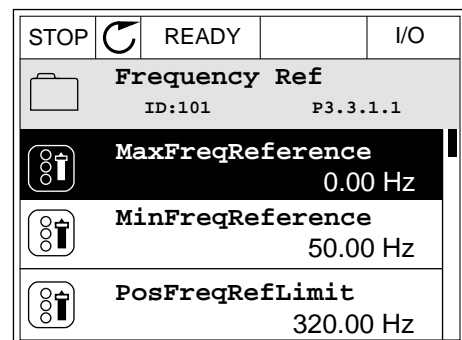

- Go to the Edit mode.

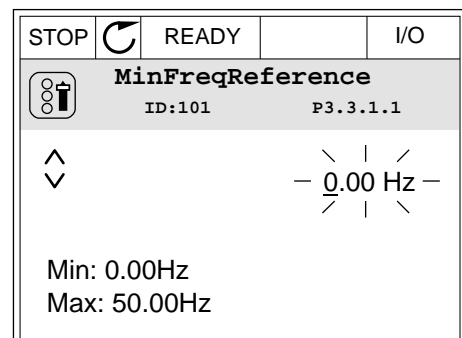

- 3 If the value is numerical, move from digit to digit with the arrow buttons Left and Right. Change the digits with the arrow buttons Up and Down.

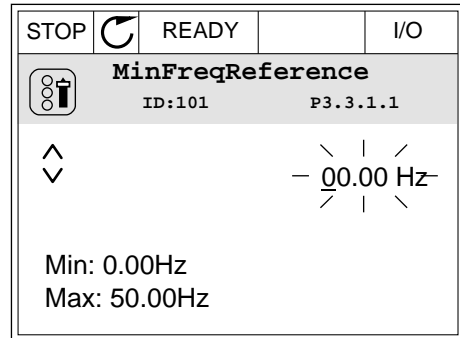

- 4 To accept the change, push the OK button. To ignore the change, go back to the level where you were before with the Back/Reset button.

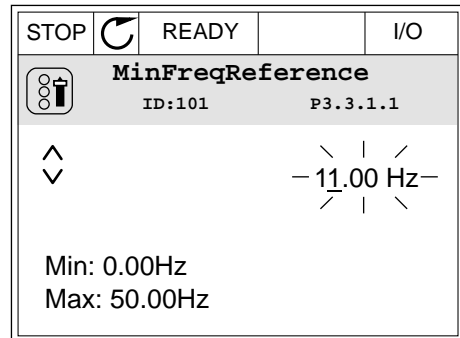

THE SELECTION OF MORE THAN 1 VALUE

Some parameters let you to make a selection of more than 1 value. Make a checkbox selection at each value you wish to activate.

- 1 Find the parameter. There is a symbol on the display when a checkbox selection is possible.

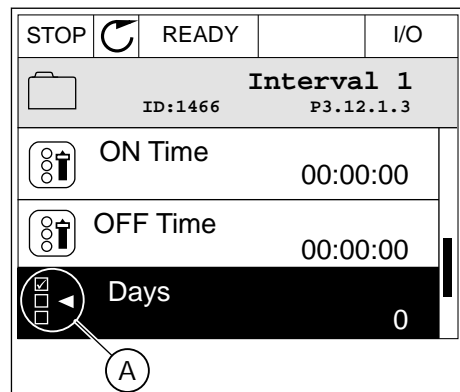

- A. The symbol of the checkbox selection

- 2 To move in the list of values, use the arrow buttons Up and Down.

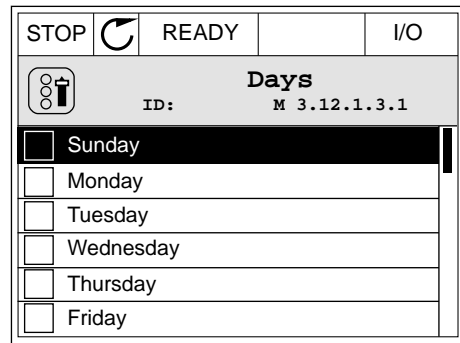

- 3 To add a value into your selection, tick the box that is next to it with the arrow button Right.

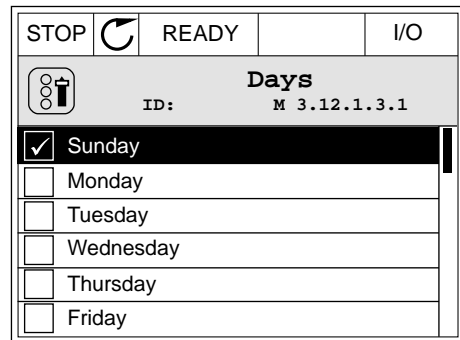

3.2.2 RESETTING A FAULT

To reset a fault, you can use the Reset button or the parameter Reset Faults. See the instructions in *10.1 A fault comes into view*.

3.2.3 THE FUNCT BUTTON

You can use the FUNCT button for 4 functions.

- To have an access to the Control page.
- To easily change between the Local and Remote control places.
- To change the rotation direction.
- To quickly edit a parameter value.

The selection of the control place determines from where the AC drive takes the start and stop commands. All the control places have a parameter for the selection of the frequency reference source. The Local control place is always the keypad. The Remote control place is I/O or Fieldbus. You can see the current control place on the status bar of the display.

It is possible to use I/O A, I/O B and Fieldbus as Remote control places. I/O A and Fieldbus have the lowest priority. You can make a selection of them with P3.2.1 (Remote Control Place). I/O B can bypass the Remote control places I/O A and Fieldbus with a digital input. You can make a selection of the digital input with parameter P3.5.1.7 (I/O B Control Force).

The keypad is always used as a control place when the control place is Local. Local control has higher priority than Remote control. For example, when you are in Remote control, if parameter P3.5.1.7 bypasses the control place with a digital input, and you make a selection of Local, Keypad becomes the control place. Use the FUNCT button or P3.2.2 Local/Remote to change between the Local and Remote control.

CHANGING THE CONTROL PLACE

1 Anywhere in the menu structure, push the FUNCT button.

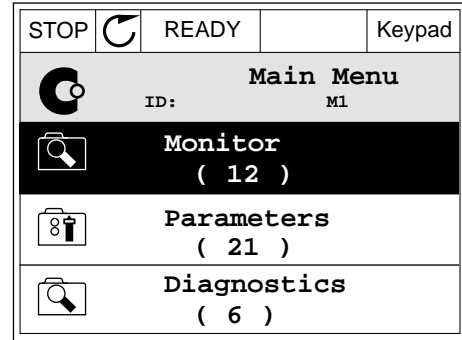

2 To make a selection of the Local/Remote, use the arrow buttons Up and Down. Push the OK button.

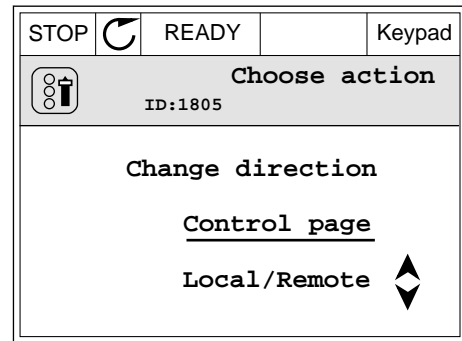

3 To make a selection of Local or Remote, use the arrow buttons Up and Down again. To accept the selection, push the OK button.

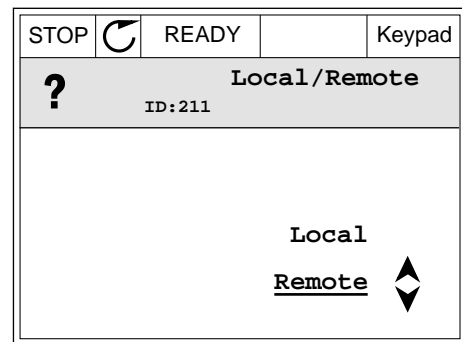

4 If you changed Remote control place to Local, that is, the keypad, give a keypad reference.

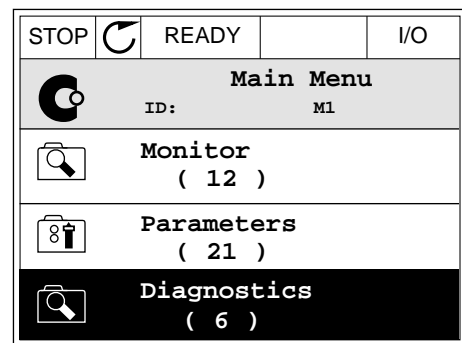

After the selection, the display goes back into the same location where it was when you pushed the FUNCT button.

GOING INTO THE CONTROL PAGE

It is easy to monitor the most important values in the Control page.

- 1 Anywhere in the menu structure, push the FUNCT button.

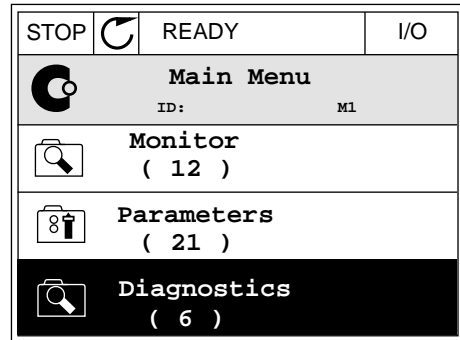

- 2 To make a selection of the Control page, push the arrow buttons Up and Down. Go in with the OK button. The control page opens.

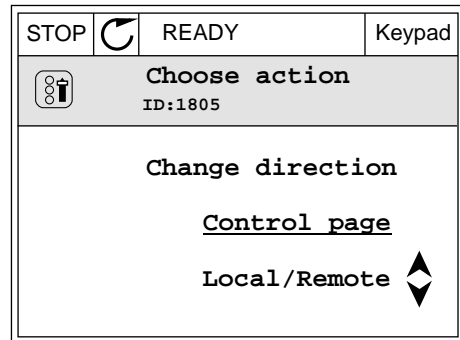

- 3 If you use the Local control place and the keypad reference, you can set P3.3.1.8 Keypad Reference with the OK button.

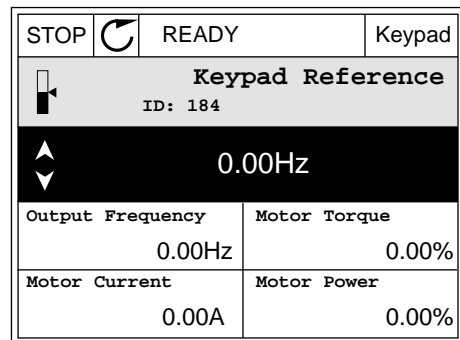

- 4 To change the digits in the value, push the arrow buttons Up and Down. Accept the change with the OK button.

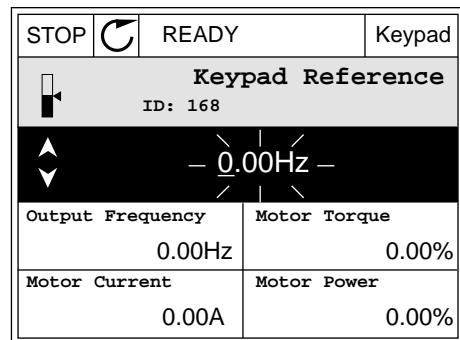

See more information about Keypad Reference in *5.3 Group 3.3: References*. If you use other control places or reference values, the display shows the frequency reference, which you

cannot edit. The other values on the page are Multimonitoring values. You can make a selection of the values that show up here (see instructions in 4.1.1 *Multimonitor*).

CHANGING THE ROTATION DIRECTION

You can change the rotation direction of the motor quickly with the FUNCT button.



NOTE!

The command Change direction is available in the menu only if the current control place is Local.

- 1 Anywhere in the menu structure, push the FUNCT button.

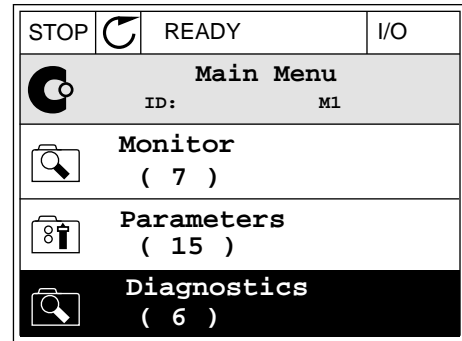

- 2 To make a selection of the Change direction, push the arrow buttons Up and Down. Push the OK button.

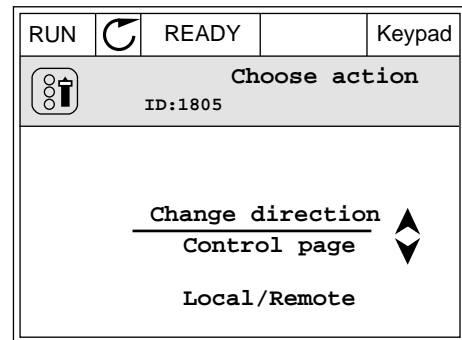

- 3 Make a selection of a new rotation direction. The current rotation direction blinks. Push the OK button.

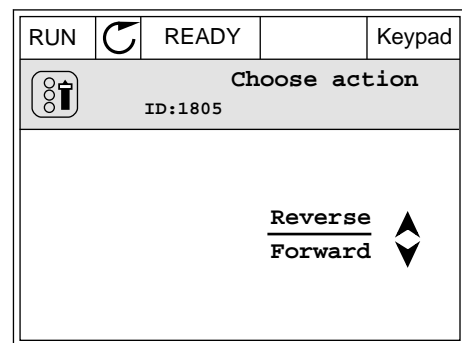

- 4 The rotation direction changes immediately. You can see that the arrow indication in the status field of the display changes.

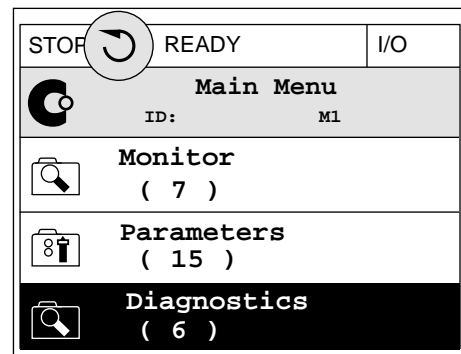

THE QUICK EDIT FUNCTION

With the Quick edit function, you can have a quick access to a parameter by typing the ID number of the parameter.

- 1 Anywhere in the menu structure, push the FUNCT button.
- 2 Push the arrow buttons Up and Down to make a selection of Quick Edit and accept with the OK button.
- 3 Write the ID number of a parameter or monitoring value. Push OK. The display shows the parameter value in the edit mode and the monitoring value in the monitoring mode.

3.2.4 COPYING THE PARAMETERS



NOTE!

This function is available only in the graphical display.

Before you can copy parameters from the control panel to the drive, you must stop the drive.

COPYING THE PARAMETERS OF AN AC DRIVE

Use this function to copy parameters from a drive to another.

- 1 Save the parameters to the control panel.
- 2 Detach the control panel and connect it to another drive.
- 3 Download the parameters to the new drive with the command Restore from keypad.

SAVING THE PARAMETERS TO THE CONTROL PANEL

1 Go into the User settings menu.

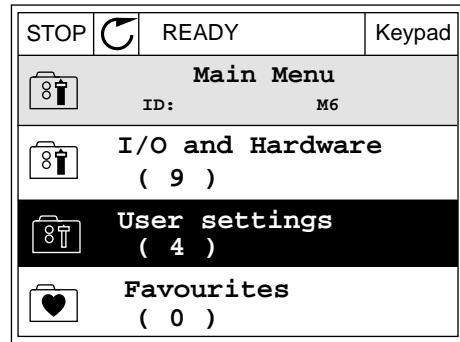

2 Go into the Parameter backup submenu.

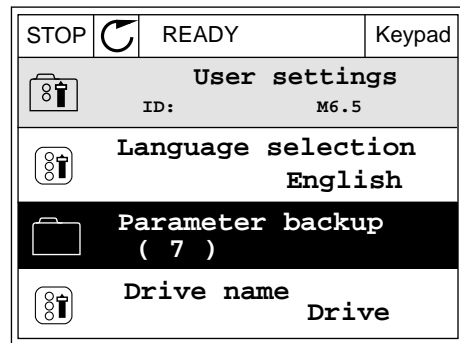

3 Use the arrow buttons Up and Down to make a selection of a function. Accept the selection with the OK button.

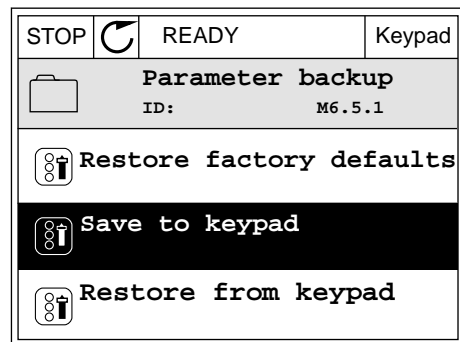

The command Restore factory defaults brings back the parameter settings that were made at the factory. With the command Save to keypad you can copy all the parameters to the control panel. The command Restore from keypad copies all the parameters from the control panel to the drive.

The parameters that you cannot copy if the drives have a different size

If you replace the control panel of a drive with a control panel from a drive that is of a different size, the values of these parameters do not change.

- Motor Nominal Current (P3.1.1.4)
- Motor Nominal Voltage (P3.1.1.1)
- Motor Nominal Speed (P3.1.1.3)
- Motor Nominal Power (P3.1.1.6)
- Motor Nominal Frequency (P3.1.1.2)
- Motor Cos Phii (P3.1.1.5)
- Switching Frequency (P3.1.2.3)
- Motor Current Limit (P3.1.3.1)
- Stall Current Limit (P3.9.3.2)
- Maximum Frequency (P3.3.1.2)
- Field Weakening Point Frequency (P3.1.4.2)
- U/f Midpoint Frequency (P3.1.4.4)
- Zero Frequency Voltage (P3.1.4.6)
- Start Magnetising Current (P3.4.3.1)
- DC Brake Current (P3.4.4.1)
- Flux Braking Current (P3.4.5.2)
- Motor Thermal Time Constant (P3.9.2.4)

3.2.5 COMPARING THE PARAMETERS

With this function, you can compare the current parameter set with 1 of these 4 sets.

- Set 1 (B6.5.4 Save to Set 1)
- Set 2 (B6.5.6 Save to Set 2)
- The defaults (P6.5.1 Restore Factory Defaults)
- The keypad set (P6.5.2 Save to Keypad)

See more about these parameters in *Table 114 The parameter backup parameters in the user settings menu.*



NOTE!

If you have not saved the parameter set with which you want to compare the current set, the display shows the text *Comparing failed.*

USING THE FUNCTION PARAMETER COMPARE

- 1 Go into Parameter Compare in the User settings menu.

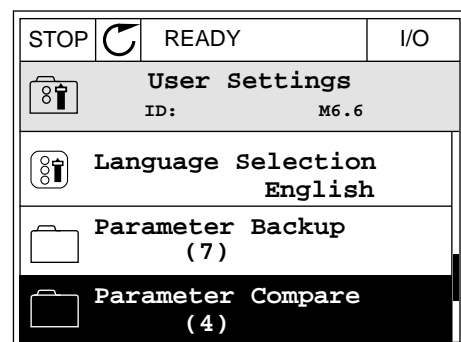

- 2 Make a selection of the pair of sets. Push OK to accept the selection.

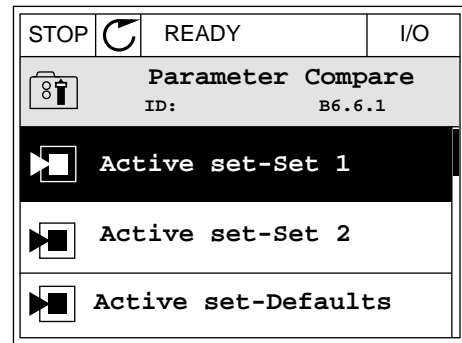

- 3 Make a selection of Activate and push OK.

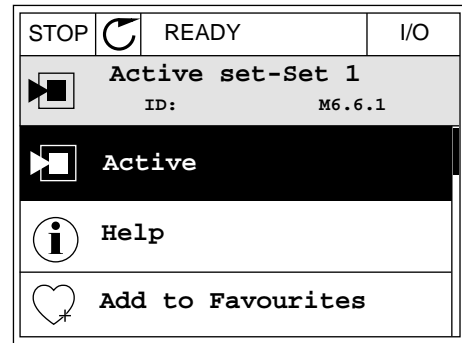

- 4 Examine the comparing between the current values and the values of the other set.

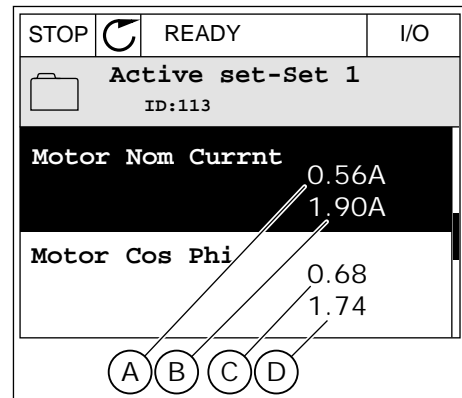

- | | |
|-------------------------------|-------------------------------|
| A. The current value | C. The current value |
| B. The value of the other set | D. The value of the other set |

3.2.6 HELP TEXTS

The graphical display can show help texts on many topics. All the parameters have a help text.

The help texts are also available for the faults, alarms, and the Startup wizard.

READING A HELP TEXT

1 Find the item about which you want to read.

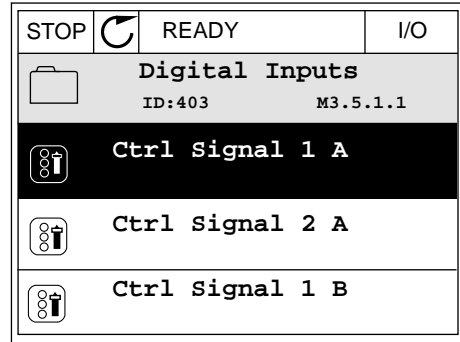

2 Use the arrow buttons Up and Down to make a selection of Help.

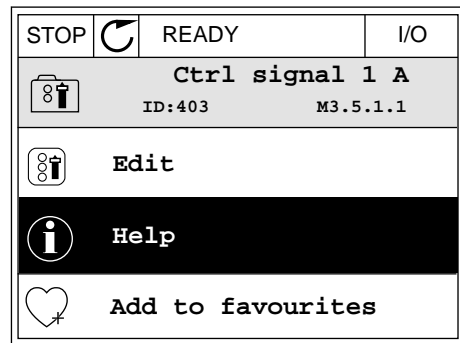

3 To open the help text, push the OK button.

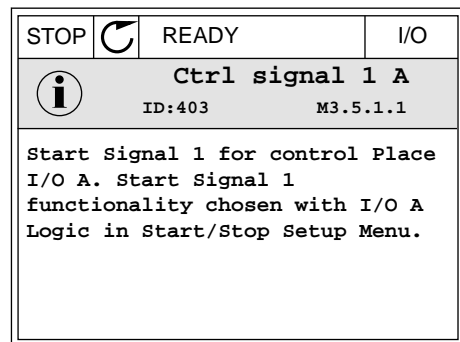

NOTE!

The help texts are always in English.

3.2.7 USING THE FAVOURITES MENU

If you use the same items frequently, you can add them into Favourites. You can collect a set of parameters or monitoring signals from all the keypad menus.

See more about how to use the Favourites menu in Chapter 8.2 *Favourites*.

3.3 USING THE TEXT DISPLAY

You can also have the control panel with the text display for your user interface. The text display and the graphical display have almost the same functions. Some functions are only available in the graphical display.

The display shows the status of the motor and the AC drive. It also shows faults in the operation of the motor and the drive. On the display, you see your current location in the menu. You also see the name of the group or item in your current location. If the text is too long for the display, the text scrolls to show the full text string.

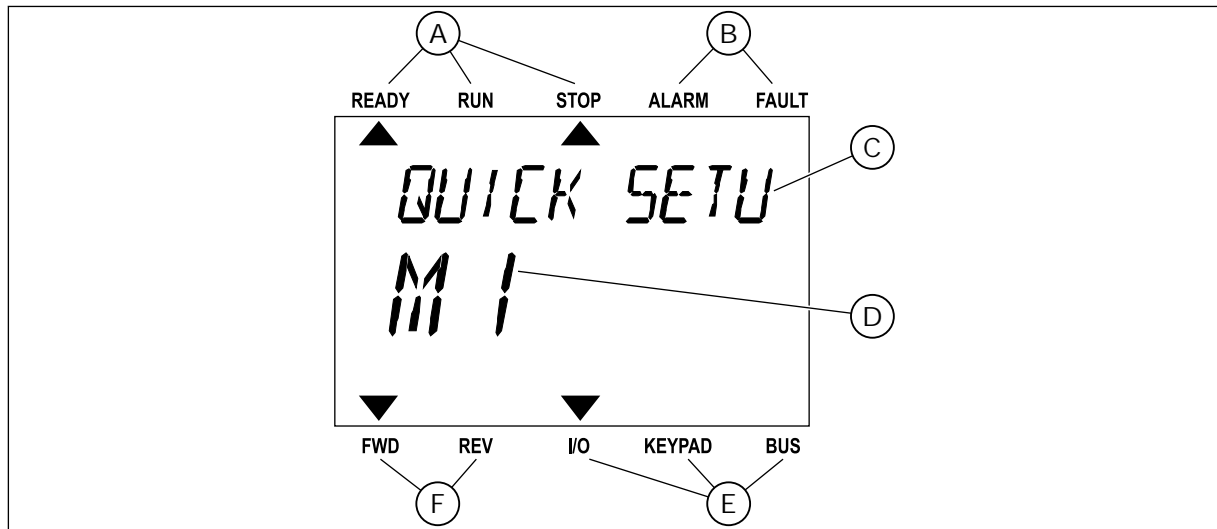

Fig. 18: The main menu of the text display

- A. The indicators of status
- B. The indicators of alarm and fault
- C. The name of the group or item of the current location
- D. The current location in the menu
- E. The indicators of the control place
- F. The indicators of the rotation direction

3.3.1 EDITING THE VALUES

CHANGING THE TEXT VALUE OF A PARAMETER

Set the value of a parameter with this procedure.

- 1 Find the parameter.



- 2 To go to the Edit mode, push the OK button.

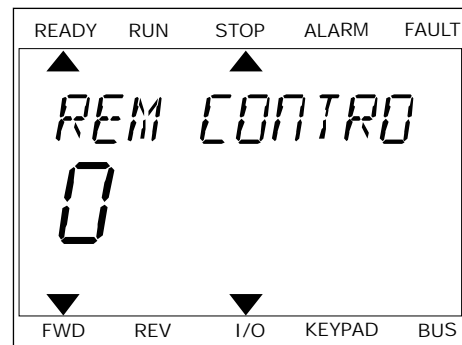

- 3 To set a new value, push the arrow buttons Up and Down.

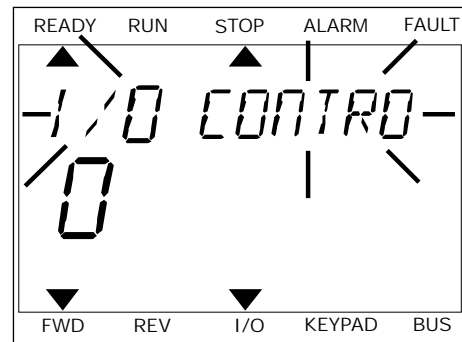

- 4 Accept the change with the OK button. To ignore the change, go back to the level where you were before with the Back/Reset button.

EDITING THE NUMERICAL VALUES

- 1 Find the parameter.
- 2 Go to the Edit mode.
- 3 Move from digit to digit with the arrow buttons Left and Right. Change the digits with the arrow buttons Up and Down.
- 4 Accept the change with the OK button. To ignore the change, go back to the level where you were before with the Back/Reset button.

3.3.2 RESETTING A FAULT

To reset a fault, you can use the Reset button or the parameter Reset Faults. See the instructions in *10.1 A fault comes into view*.

3.3.3 THE FUNCT BUTTON

You can use the FUNCT button for 4 functions.

- To have an access to the Control page.
- To easily change between the Local and Remote control places.
- To change the rotation direction.
- To quickly edit a parameter value.

The selection of the control place determines from where the AC drive takes the start and stop commands. All the control places have a parameter for the selection of the frequency reference source. The Local control place is always the keypad. The Remote control place is I/O or Fieldbus. You can see the current control place on the status bar of the display.

It is possible to use I/O A, I/O B and Fieldbus as Remote control places. I/O A and Fieldbus have the lowest priority. You can make a selection of them with P3.2.1 (Remote Control Place). I/O B can bypass the Remote control places I/O A and Fieldbus with a digital input. You can make a selection of the digital input with parameter P3.5.1.7 (I/O B Control Force).

The keypad is always used as a control place when the control place is Local. Local control has higher priority than Remote control. For example, when you are in Remote control, if parameter P3.5.1.7 bypasses the control place with a digital input, and you make a selection of Local, Keypad becomes the control place. Use the FUNCT button or P3.2.2 Local/Remote to change between the Local and Remote control.

CHANGING THE CONTROL PLACE

- 1 Anywhere in the menu structure, push the FUNCT button.

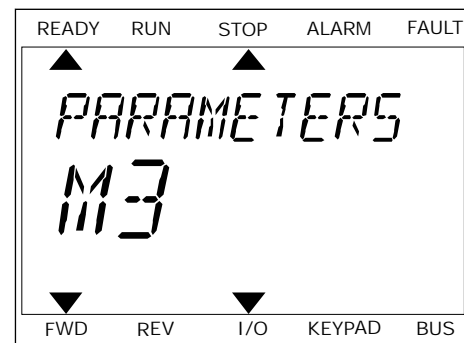

- 2 To make a selection of the Local/Remote, use the arrow buttons Up and Down. Push the OK button.



- 3 To make a selection of Local or Remote, use the arrow buttons Up and Down again. To accept the selection, push the OK button.

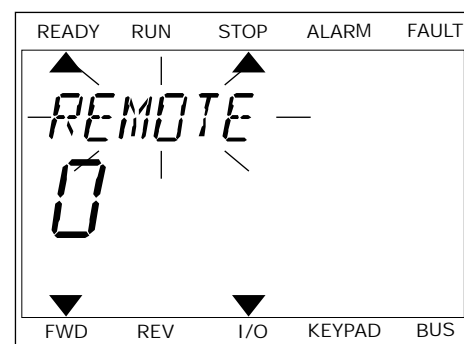

- 4 If you changed Remote control place to Local, that is, the keypad, give a keypad reference.

After the selection, the display goes back into the same location where it was when you pushed the FUNCT button.

GOING INTO THE CONTROL PAGE

It is easy to monitor the most important values in the Control page.

- 1 Anywhere in the menu structure, push the FUNCT button.

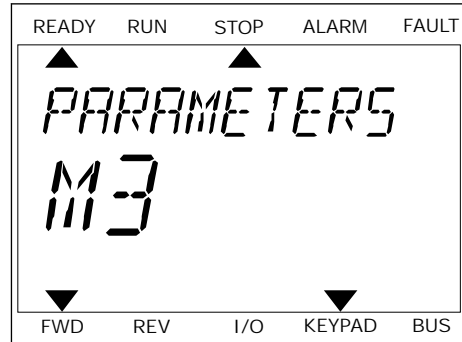

- 2 To make a selection of the Control page, push the arrow buttons Up and Down. Go in with the OK button. The control page opens.

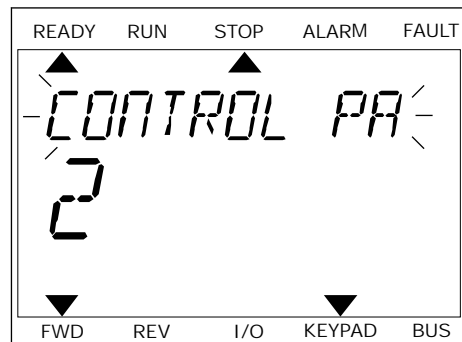

- 3 If you use the Local control place and the keypad reference, you can set P3.3.1.8 Keypad Reference with the OK button.

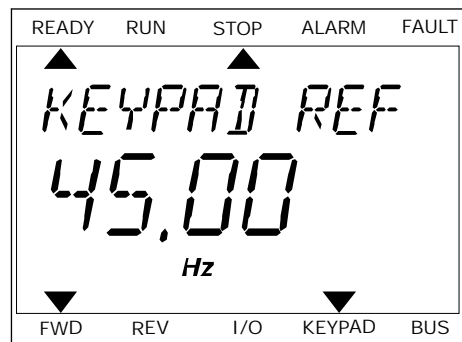

See more information about the Keypad Reference in *5.3 Group 3.3: References*). If you use other control places or reference values, the display shows the frequency reference, which you cannot edit. The other values on the page are Multimonitoring values. You can make a selection of the values that show up here (see instructions in *4.1.1 Multimonitor*).

CHANGING THE ROTATION DIRECTION

You can change the rotation direction of the motor quickly with the FUNCT button.

**NOTE!**

The command Change direction is available in the menu only if the current control place is Local.

- 1 Anywhere in the menu structure, push the FUNCT button.
- 2 To make a selection of the Change direction, push the arrow buttons Up and Down. Push the OK button.
- 3 Make a selection of a new rotation direction. The current rotation direction blinks. Push the OK button. The rotation direction changes immediately, and the arrow indication in the status field of the display changes.

THE QUICK EDIT FUNCTION

With the Quick edit function, you can have a quick access to a parameter by typing the ID number of the parameter.

- 1 Anywhere in the menu structure, push the FUNCT button.
- 2 Push the arrow buttons Up and Down to make a selection of Quick Edit and accept with the OK button.
- 3 Write the ID number of a parameter or monitoring value. Push OK. The display shows the parameter value in the edit mode and the monitoring value in the monitoring mode.

3.4 MENU STRUCTURE

Menu	Function
Quick setup	See Chapter <i>1.4 Description of the applications.</i>
Monitor	Multimonitor
	Trend curve
	Basic
	I/O
	Extras/Advanced
	Timer functions
	PID controller
	External PID controller
	Multipump
	Maintenance counters
	Fiedbus data
Parameters	See Chapter <i>5 Parameters menu.</i>
Diagnostics	Active faults
	Reset faults
	Fault history
	Total counters
	Trip counters
	Software info

Menu	Function
I/O and hardware	Basic I/O
	Slot C
	Slot D
	Slot E
	Real time clock
	Power unit settings
	Keypad
	RS-485
	Ethernet
User settings	Language selections
	Parameter backup *
	Drive name
	Parameter compare
Favourites *	See Chapter 8.2 <i>Favourites</i> .
User levels	See Chapter 8.3 <i>User levels</i> .

* = The function is not available in the control panel with a text display.

3.4.1 QUICK SETUP

The Quick Setup group includes the different wizards and quick setup parameters of the Vacon 100 Application. More detailed information on the parameters of this group you will find in chapter 1.3 *First start-up* and 2 *Wizards*.

3.4.2 MONITOR

MULTIMONITOR

With the Multimonitor function, you can collect 4 to 9 items to monitor. See 4.1.1 *Multimonitor*.

**NOTE!**

The Multimonitor menu is not available in the text display.

TREND CURVE

The Trend Curve function is a graphical presentation of 2 monitor values at the same time. See *4.1.2 Trend curve*.

BASIC

The basic monitoring values can include statuses, measurements, and the actual values of parameters and signals. See *4.1.3 Basic*.

I/O

It is possible to monitor the statuses and levels of the values of input and output signals. See *4.1.4 I/O*.

EXTRAS/ADVANCED

You can monitor different advanced values, for example fieldbus values. See *4.1.6 Extras and advanced*.

TIMER FUNCTIONS

With this function, you can monitor the timer functions and the Real Time Clock. See *4.1.7 Timer functions monitoring*.

PID CONTROLLER

With this function, you can monitor the PID controller values. See *4.1.8 PID controller monitoring*.

EXTERNAL PID CONTROLLER

Monitor the values that are related to the external PID controller. See *4.1.9 External PID controller monitoring*.

MULTI-PUMP

Use this function to monitor the values that are related to the operation of more than 1 drive. See *4.1.10 Multipump monitoring*.

MAINTENANCE COUNTERS

Monitor the values related to the maintenance counters. See *4.1.11 Maintenance counters*.

FIELDBUS DATA

With this function, you see the fieldbus data as monitor values. Use this function, for example, for monitoring during the fieldbus commissioning. See *4.1.12 Fieldbus data monitoring*.

3.5 VACON LIVE

Vacon Live is a PC tool for commissioning and maintenance of the Vacon® 10, Vacon® 20, and Vacon® 100 AC drives). You can download Vacon Live from www.vacon.com.

The Vacon Live PC tool includes these functions.

- Parametrisation, monitoring, drive info, data logger, etc.
- The software download tool Vacon Loader
- RS-422 and Ethernet support
- Windows XP, Vista 7 and 8 support
- 17 languages: English, German, Spanish, Finnish, French, Italian, Russian, Swedish, Chinese, Czech, Danish, Dutch, Polish, Portuguese, Romanian, Slovak and Turkish

You can make the connection between the AC drive and the PC tool with the black USB/RS-422 cable from Vacon or the Vacon 100 Ethernet cable. The RS-422 drivers are installed automatically during the installation of Vacon Live. After you installed the cable, Vacon Live finds the connected drive automatically.

See more on how to use Vacon Live in the help menu of the program.

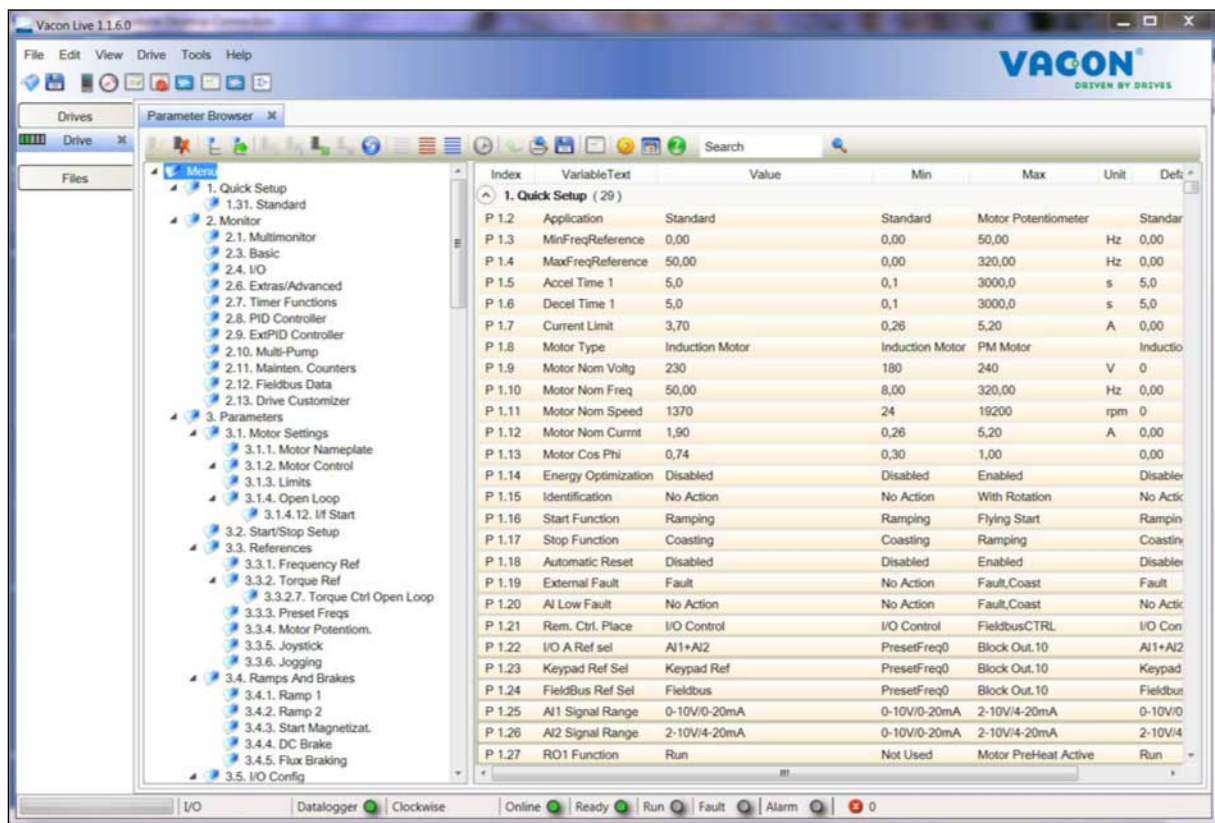

Fig. 19: The Vacon Live PC tool

4 MONITORING MENU

4.1 MONITOR GROUP

You can monitor the actual values of the parameters and signals. You can also monitor the statuses and measurements. You can customise some of the values that you can monitor.

4.1.1 MULTIMONITOR

On the Multimonitor page, you can collect 4 to 9 items to monitor. Make a selection of the number of items with the parameter 3.11.4 Multimonitor View. See more in chapter 5.11 *Group 3.11: Application settings*.

CHANGING THE ITEMS TO MONITOR

1 Go into the Monitor menu with the OK button.

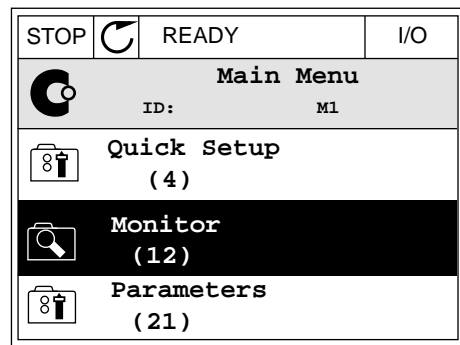

2 Go into Multimonitor.

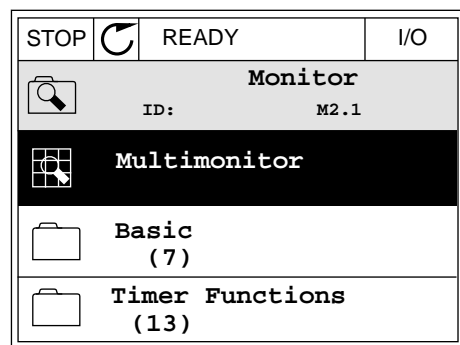

3 To replace an old item, activate it. Use the arrow buttons.

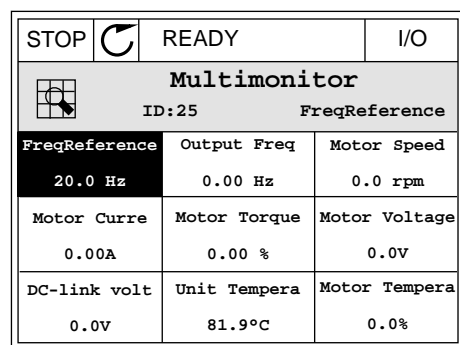

- To make a selection of a new item in the list, push OK.

STOP		READY	I/O
FreqReference			
ID:1		M2.1.1.1	
<input checked="" type="checkbox"/>	Output frequency	0.00 Hz	
<input checked="" type="checkbox"/>	FreqReference	10.00 Hz	
<input checked="" type="checkbox"/>	Motor Speed	0.00 rpm	
<input checked="" type="checkbox"/>	Motor Current	0.00 A	
<input checked="" type="checkbox"/>	Motor Torque	0.00 %	
<input type="checkbox"/>	Motor Power	0.00 %	

4.1.2 TREND CURVE

The Trend curve is a graphical presentation of 2 monitor values.

When you make a selection of a value, the drive starts to record the values. In the Trend curve submenu, you can examine the trend curve, make the signal selections. You can also give the minimum and maximum settings and the sampling interval, and use Autoscaling.

CHANGING THE VALUES

Change the monitoring values with this procedure.

- In the Monitor menu, find the Trend curve submenu and push OK.

STOP		READY	I/O
Monitor			
ID:		M2.2	
	Multimonitor		
	Trend Curve	(7)	
	Basic	(13)	

- Go into the submenu View trend curve with the OK button.

STOP		READY	I/O
Trend Curve			
ID:		M2.2.1	
	View Trend Curve	(2)	
	Sampling interval	100 ms	
	Channel 1 min	-1000	

- 3 You can monitor only 2 values as trend curves at the same time. The current selections, FreqReference and Motor speed, are at the bottom of the display. To make a selection of the current value that you wish to change, use the arrow buttons up and down. Push OK.

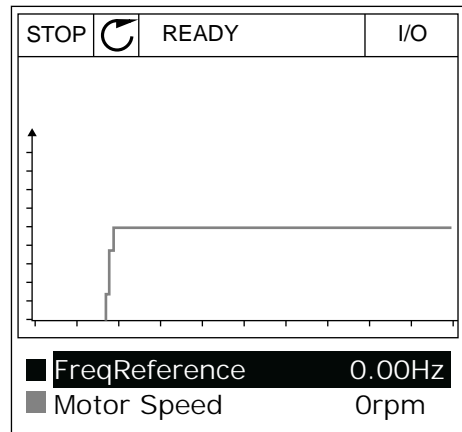

- 4 Go through the list of the monitoring values with the arrow buttons.

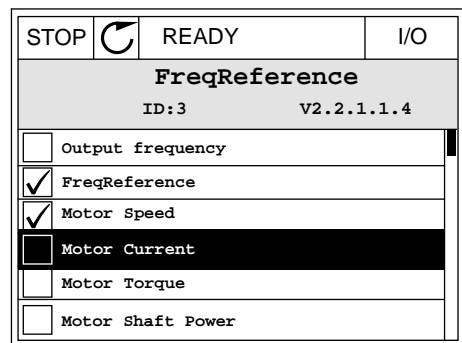

- 5 Make a selection and push OK.

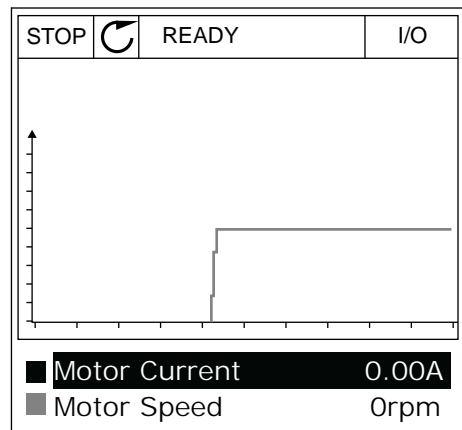

STOPPING THE PROGRESSION OF THE CURVE

The Trend curve function also lets you to stop the curve and read the current values. After, you can start the progression of the curve again.

- 1 In Trend curve view, make a curve active with the arrow button Up. The frame of the display turns bold.

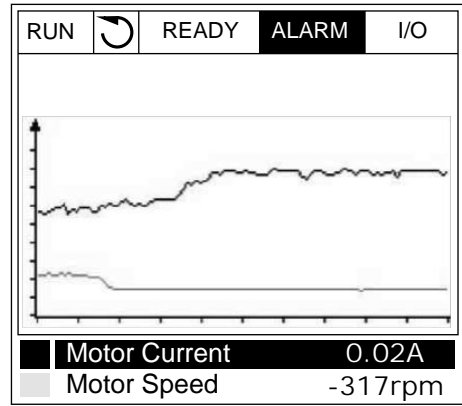

- 2 Push OK at the target point of the curve.

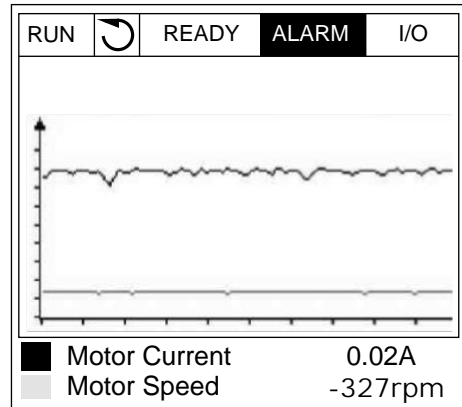

- 3 A vertical line comes into view on the display. The values at the bottom of the display agree to the location of the line.

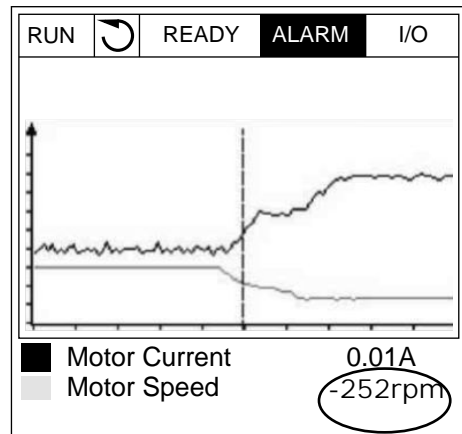

- 4 To move the line to see the values of some other location, use the arrow buttons Left and Right.

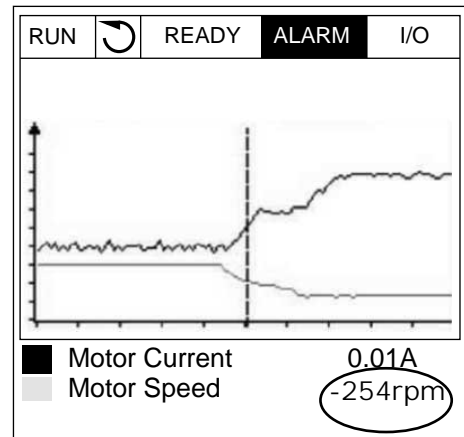

Table 20: The trend curve parameters

Index	Parameter	Min	Max	Unit	Default	ID	Description
M2.2.1	View Trend curve						Go into this menu to monitor values in a curve form.
P2.2.2	Sampling interval	100	432000	ms	100	2368	Set the sampling interval.
P2.2.3	Channel 1 min	-214748	1000		-1000	2369	Used in scaling by default. Adjustments can be necessary.
P2.2.4	Channel 1 max	-1000	214748		1000	2370	Used in scaling by default. Adjustments can be necessary.
P2.2.5	Channel 2 min	-214748	1000		-1000	2371	Used in scaling by default. Adjustments can be necessary.
P2.2.6	Channel 2 max	-1000	214748		1000	2372	Used in scaling by default. Adjustments can be necessary.
P2.2.7	Autoscale	0	1		0	2373	If the value of this parameter is 1, the signal is automatically scaled between the min and max values.

4.1.3 BASIC

You can see the basic monitoring values and their related data in the next table.

**NOTE!**

Only the standard I/O board statuses are available in the Monitor menu. You can find the statuses of all the I/O board signals as raw data in the I/O and Hardware menu.

Do a check of the statuses of the expander I/O board in the I/O and Hardware menu when the system asks you to do it.

Table 21: Items in the monitoring menu

Index	Monitoring value	Unit	Scale	ID	Description
V2.3.1	Output frequency	Hz	0.01	1	The output frequency to motor
V2.3.2	Frequency reference	Hz	0.01	25	The frequency reference to motor control
V2.3.3	Motor speed	rpm	1	2	The actual speed of the motor in rpm
V2.3.4	Motor current	A	Varies	3	
V2.3.5	Motor torque	%	0.1	4	The calculated shaft torque
V2.3.7	Motor shaft power	%	0.1	5	The calculated motor shaft power in percentage
V2.3.8	Motor shaft power	kW/hp	Varies	73	The calculated motor shaft power in kW or hp. The unit is set in the unit selection parameter.
V2.3.9	Motor voltage	V	0.1	6	The output voltage to motor
V2.3.10	DC link voltage	V	1	7	The measured voltage in the DC-link of the drive
V2.3.11	Unit temperature	°C	0.1	8	The heatsink temperature in Celsius or Fahrenheit
V2.3.12	Motor temperature	%	0.1	9	The calculated motor temperature in percentage of the nominal working temperature
V2.3.13	Motor Preheat		1	1228	The status of the Motor preheat function 0 = OFF 1 = Heating (feeding DC-current)
V2.3.14	Torque reference	%	0.1	18	The final torque reference to motor control

4.1.4 I/O

Table 22: I/O signal monitoring

Index	Monitoring value	Unit	Scale	ID	Description
V2.4.1	Slot A DIN 1, 2, 3		1	15	Shows the status of the digital inputs 1-3 in slot A (standard I/O)
V2.4.2	Slot A DIN 4, 5, 6		1	16	Shows the status of the digital inputs 4-6 in slot A (standard I/O)
V2.4.3	Slot B RO 1, 2, 3		1	17	Shows the status of the relay inputs 1-3 in slot B
V2.4.4	Analogue input 1	%	0.01	59	The input signal as a percentage of the used range. Slot A.1 as default.
V2.4.5	Analogue input 2	%	0.01	60	The input signal as a percentage of the used range. Slot A.2 as default.
V2.4.6	Analogue input 3	%	0.01	61	The input signal as a percentage of the used range. Slot D.1 as default.
V2.4.7	Analogue input 4	%	0.01	62	The input signal as a percentage of the used range. Slot D.2 as default.
V2.4.8	Analogue input 5	%	0.01	75	The input signal as a percentage of the used range. Slot E.1 as default.
V2.4.9	Analogue input 6	%	0.01	76	The input signal as a percentage of the used range. Slot E.2 as default.
V2.4.10	Slot A AO1	%	0.01	81	The analogue output signal as a percentage of the used range. Slot A (standard I/O)

4.1.5 TEMPERATURE INPUTS

**NOTE!**

This parameter group is visible when you have an option board for temperature measurement (OPT-BH).

Table 23: Monitoring the temperature inputs

Index	Monitoring value	Unit	Scale	ID	Description
V2.5.1	Temperature input 1	°C	0.1	50	The measured value of temperature input 1. The list of temperature inputs is made of the first 6 available temperature inputs. The list starts from slot A and ends in slot E. If an input is available but no sensor is connected, the list shows the maximum value because the measured resistance is endless. To make the value go to its minimum value, hardwire the input.
V2.5.2	Temperature input 2	°C	0.1	51	The measured value of temperature input 2. See more above.
V2.5.3	Temperature input 3	°C	0.1	52	The measured value of temperature input 3. See more above.
V2.5.4	Temperature input 4	°C	0.1	69	The measured value of temperature input 4. See more above.
V2.5.5	Temperature input 5	°C	0.1	70	The measured value of temperature input 5. See more above.
V2.5.6	Temperature input 6	°C	0.1	71	The measured value of temperature input 6. See more above.

4.1.6 EXTRAS AND ADVANCED

Table 24: Monitoring of the advanced values

Index	Monitoring value	Unit	Scale	ID	Description
V2.6.1	Drive Status Word		1	43	<p>The bit-coded word</p> <p>B1 = Ready B2 = Run B3 = Fault B6 = RunEnable B7 = AlarmActive B10 = DC current in stop B11 = DC brake active B12 = RunRequest B13 = MotorRegulatorActive</p>
V2.6.2	Ready status		1	78	<p>Bit-coded data about ready criteria. This data is useful for monitoring when the drive is not in the Ready state. The values are visible as checkboxes on the graphical display. If a box is ticked, the value is active.</p> <p>B0 = RunEnable high B1 = No fault active B2 = Charge switch closed B3 = DC voltage within limits B4 = Power manager initialised B5 = Power unit is not blocking start B6 = System software is not blocking start</p>
V2.6.3	Application Status Word1		1	89	<p>Bit-coded statuses of the application. The values are visible as checkboxes on graphical display. If a box is ticked, the value is active.</p> <p>B0 = Interlock 1 B1 = Interlock 2 B2 = Reserved B3 = Ramp 2 active B4 = Mechanical brake control B5 = I/O A control active B6 = I/O B control active B7 = Fieldbus Control Active B8 = Local control active B9 = PC control active B10 = Preset frequencies active B11 = Jogging active B12 = Fire Mode active B13 = Motor Preheat active B14 = Quick stop active B15 = Drive stopped from keypad</p>

Table 24: Monitoring of the advanced values

Index	Monitoring value	Unit	Scale	ID	Description
V2.6.4	Application Status Word2		1	90	Bit-coded statuses of the application. The values are visible as checkboxes on graphical display. If a box is ticked, the value is active. B0 = Acc/Dec prohibited B1 = Motor switch open B5 = Jockey pump active B6 = Priming pump active B7 = Input pressure supervision (Alarm/Fault) B8 = Frost protection (Alarm/Fault) B9 = Autocleaning active
V2.6.5	DIN Status Word 1		1	56	A 16-bit word where each bit shows the status of 1 digital input. 6 digital inputs from each slot are read. Word 1 starts from the input 1 in slot A (bit0) and goes all the way to input 4 in slot C (bit15).
V2.6.6	DIN Status Word 2		1	57	A 16-bit word where each bit shows the status of 1 digital input. 6 digital inputs from each slot are read. Word 2 starts from the input 5 in slot C (bit0) and goes all the way to input 6 in slot E (bit13).
V2.6.7	Motor current 1 decimal		0.1	45	The monitor value of the motor current with fixed number of decimals and less filtering. This can be used for example with fieldbus to get the correct value so that the frame size does not have an effect. or for monitoring when less filtering time is needed for the motor current.
V2.6.8	Frequency reference source		1	1495	Shows the momentary frequency reference source. 0 = PC 1 = Preset Freqs 2 = Keypad Reference 3 = Fieldbus 4 = AI1 5 = AI2 6 = AI1+AI2 7 = PID Controller 8 = Motor Potentiom. 9 = Joystick 10 = Jogging 100 = Not defined 101 = Alarm, PresetFreq 102 = Auto-cleaning
V2.6.9	Last active fault code		1	37	The fault code of the last fault that has not been reset.

Table 24: Monitoring of the advanced values

Index	Monitoring value	Unit	Scale	ID	Description
V2.6.10	Last active fault ID		1	95	The fault ID of the last fault that has not been reset.
V2.6.11	Last active alarm code		1	74	The alarm code of the last alarm that has not been reset.
V2.6.12	Last active alarm ID		1	94	The alarm ID of the last alarm that has not been reset.

4.1.7 TIMER FUNCTIONS MONITORING

Monitor the values of Timer functions and the Real Time Clock.

Table 25: Monitoring of the timer functions

Index	Monitoring value	Unit	Scale	ID	Description
V2.7.1	TC 1, TC 2, TC 3		1	1441	You can monitor the statuses of the 3 time channels (TC)
V2.7.2	Interval 1		1	1442	The status of the timer interval
V2.7.3	Interval 2		1	1443	The status of the timer interval
V2.7.4	Interval 3		1	1444	The status of the timer interval
V2.7.5	Interval 4		1	1445	The status of the timer interval
V2.7.6	Interval 5		1	1446	The status of the timer interval
V2.7.7	Timer 1	s	1	1447	The remaining time on the timer if the timer is active
V2.7.8	Timer 2	s	1	1448	The remaining time on the timer if the timer is active
V2.7.9	Timer 3	s	1	1449	The remaining time on the timer if the timer is active
V2.7.10	Real time clock			1450	hh:mm:ss

4.1.8 PID CONTROLLER MONITORING

Table 26: Monitoring of the values of the PID controller

Index	Monitoring value	Unit	Scale	ID	Description
V2.8.1	PID1 setpoint	Varies	As is set in P3.13.1.7 (See 5.13 Group 3.13: PID controller)	20	The setpoint value of the PID controller in process units. You can use a parameter to make the selection of the process unit.
V2.8.2	PID1 feedback	Varies	As is set in P3.13.1.7	21	The feedback value of the PID controller in process units. You can use a parameter to make the selection of the process unit.
V2.8.3	PID1 error value	Varies	As is set in P3.13.1.7	22	The error value of the PID controller. It is the deviation of feedback from the setpoint in process units. You can use a parameter to make the selection of the process unit.
V2.8.4	PID1 output	%	0.01	23	The PID output as a percentage (0..100%). It is possible to give this value to the motor control (frequency reference) or to an analogue output.
V2.8.5	PID1 status		1	24	0 = Stopped 1 = Running 3 = Sleep mode 4 = In dead band (see 5.13 Group 3.13: PID controller)

4.1.9 EXTERNAL PID CONTROLLER MONITORING

Table 27: Monitoring of the values of the external PID controller

Index	Monitoring value	Unit	Scale	ID	Description
V2.9.1	ExtPID setpoint	Varies	As set in P3.14.1.1 0 (See 5.14 Group 3.14: External PID controller)	83	The setpoint value of the external PID controller in process units. You can use a parameter to make the selection of the process unit.
V2.9.2	ExtPID feedback	Varies	As set in P3.14.1.1 0	84	The feedback value of the external PID controller in process units. You can use a parameter to make the selection of the process unit.
V2.9.3	ExtPID error value	Varies	As set in P3.14.1.1 0	85	The error value of the external PID controller. It is the deviation of feedback from the setpoint in process units. You can use a parameter to make the selection of the process unit.
V2.9.4	ExtPID output	%	0.01	86	The external PID controller output as a percentage (0..100%). It is possible to give this value to, for example, the analogue output.
V2.9.5	ExtPID status		1	87	0=Stopped 1=Running 2=In dead band (see 5.14 Group 3.14: External PID controller)

4.1.10 MULTIPUMP MONITORING

Table 28: Multipump monitoring

Index	Monitoring value	Unit	Scale	ID	Description
V2.10.1	Motors running		1	30	The number of motors that operate when the Multi-pump function is used.
V2.10.2	Autochange		1	1113	The system tells you if an autochange is necessary.

4.1.11 MAINTENANCE COUNTERS

Table 29: Maintenance counter monitoring

Index	Monitoring value	Unit	Scale	ID	Description
V2.11.1	Maintenance counter 1	h/ kRev	Varies	1101	The status of the maintenance counter as revolutions multiplied by 1000, or in hours. For the configuration and activation of this counter, see 5.16 Group 3.16: Maintenance counters.

4.1.12 FIELDBUS DATA MONITORING

Table 30: Fieldbus data monitoring

Index	Monitoring value	Unit	Scale	ID	Description
V2.12.1	FB Control Word		1	874	The fieldbus control word that the application uses in bypass mode/format. Depending on the fieldbus type or profile, the data can be modified before it is sent to the application.
V2.12.2	FB Speed Reference		Varies	875	The speed reference scaled between the minimum and the maximum frequency at the moment when the application received it. You can change the minimum and the maximum frequencies after the application received the reference without an effect on the reference.
V2.12.3	FB data in 1		1	876	The raw value of process data in a 32-bit signed format
V2.12.4	FB data in 2		1	877	The raw value of process data in a 32-bit signed format
V2.12.5	FB data in 3		1	878	The raw value of process data in a 32-bit signed format
V2.12.6	FB data in 4		1	879	The raw value of process data in a 32-bit signed format
V2.12.7	FB data in 5		1	880	The raw value of process data in a 32-bit signed format
V2.12.8	FB data in 6		1	881	The raw value of process data in a 32-bit signed format
V2.12.9	FB data in 7		1	882	The raw value of process data in a 32-bit signed format
V2.12.10	FB data in 8		1	883	The raw value of process data in a 32-bit signed format
V2.12.11	FB Status Word		1	864	The fieldbus status word that the application sends in bypass mode/format. Depending on the fieldbus type or profile, the data can be modified before it is sent to the fieldbus.
V2.12.12	FB Speed Actual		0.01	865	The actual speed as a percentage. The value 0% agrees with the minimum frequency and the value 100% agrees with the maximum frequency. This is continuously updated depending on the momentary min and max frequencies and the output frequency.
V2.12.13	FB data out 1		1	866	The raw value of process data in a 32-bit signed format
V2.12.14	FB data out 2		1	867	The raw value of process data in a 32-bit signed format

Table 30: Fieldbus data monitoring

Index	Monitoring value	Unit	Scale	ID	Description
V2.12.15	FB data out 3		1	868	The raw value of process data in a 32-bit signed format
V2.12.16	FB data out 4		1	869	The raw value of process data in a 32-bit signed format
V2.12.17	FB data out 5		1	870	The raw value of process data in a 32-bit signed format
V2.12.18	FB data out 6		1	871	The raw value of process data in a 32-bit signed format
V2.12.19	FB data out 7		1	872	The raw value of process data in a 32-bit signed format
V2.12.20	FB data out 8		1	873	The raw value of process data in a 32-bit signed format

5 PARAMETERS MENU

5.1 GROUP 3.1: MOTOR SETTINGS

Table 31: Motor nameplate parameters

Index	Parameter	Min	Max	Unit	Default	ID	Description
P3.1.1.1	Motor Nominal Voltage	Varies	Varies	V	Varies	110	Find the value U_n on the rating plate of the motor. Find out if the motor connection is Delta or Star.
P3.1.1.2	Motor Nominal Frequency	8.00	320.00	Hz	50 / 60	111	Find the value f_n on the rating plate of the motor.
P3.1.1.3	Motor Nominal Speed	24	19200	rpm	Varies	112	Find the value n_n on the rating plate of the motor.
P3.1.1.4	Motor Nominal Current	$I_H * 0.1$	$I_H * 2$	A	Varies	113	Find the value I_n on the rating plate of the motor.
P3.1.1.5	Motor Cos Phi (Power Factor)	0.30	1.00		Varies	120	Find the value on the rating plate of the motor.
P3.1.1.6	Motor Nominal Power	Varies	Varies	kW	Varies	116	Find the value P_n on the rating plate of the motor.

Table 32: Motor control settings



Index	Parameter	Min	Max	Unit	Default	ID	Description
P3.1.2.1 	Control Mode	0	2		0	600	0 = Frequency control (open loop) 1 = Speed control (open loop) 2 = Torque control (open loop)
P3.1.2.2 	Motor Type	0	1		0	650	0 = Induction motor 1 = PM motor
P3.1.2.3	Switching Frequency	1.5	Varies	kHz	Varies	601	If you increase the switching frequency, the capacity of the AC drive reduces. To reduce capacitive currents in the motor cable, when the cable is long, we recommend that you use a low switching frequency. To reduce the motor noise, use a high switching frequency.
P3.1.2.4 	Identification	0	2		0	631	Identification calculates or measures the motor parameters that are necessary for a good control of the motor and speed. 0 = No action 1 = At standstill 2 = With rotation Before you do the identification run, you must set the motor nameplate parameters in the menu M3.1.1.

Table 32: Motor control settings



Index	Parameter	Min	Max	Unit	Default	ID	Description
P3.1.2.5	Magnetizing Current	0.0	2*IH	A	0.0	612	The magnetising current (no-load current) of the motor. The magnetising current identifies the values of the U/f parameters if they are given before the identification run. If the value is set to 0, the magnetising current is calculated internally.
P3.1.2.6 	Motor Switch	0	1		0	653	When you enable this function, the drive does not trip when the motor switch is closed and opened, for example in a flying start. 0 = Disabled 1 = Enabled
P3.1.2.7 	Load Drooping	0.00	20.00	%	0.00	620	The function enables a speed drop as a function of load. The load drooping is given as a percentage of the nominal speed at a nominal load.
P3.1.2.8	Load Drooping Time	0.00	2.00	s	0.00	656	Use load drooping to get a dynamic speed drooping when the load changes. This parameter gives the time during which the speed is restored 63% of the change.
P3.1.2.9	Load Drooping Mode	0	1		0	1534	0 = Normal. The load drooping factor is constant through the frequency range. 1 = Linear removal. The load drooping is removed linearly from the nominal frequency to zero frequency.

Table 32: Motor control settings





Index	Parameter	Min	Max	Unit	Default	ID	Description
P3.1.2.10 	Overvoltage Control	0	1		1	607	0 = Disabled 1 = Enabled
P3.1.2.11 	Undervoltage Control	0	1		1	608	0 = Disabled 1 = Enabled
P3.1.2.12	Energy Optimization	0	1		0	666	To save energy and to lower the motor noise, the drive searches for the minimum motor current. You can use this function for example in fan and pump processes. Do not use the function with fast PID controlled processes. 0 = Disabled 1 = Enabled
P3.1.2.13 	Stator Voltage Adjust	50.0	150.0	%	100.0	659	Use this to adjust the stator voltage in permanent magnet motors.
P3.1.2.14 	Overmodulation	0	1		1	1515	0 = Disabled 1 = Enabled

Table 33: Motor limit settings

Index	Parameter	Min	Max	Unit	Default	ID	Description
P3.1.3.1 	Motor Current Limit	$I_H \cdot 0.1$	I_S	A	Varies	107	The maximum motor current from the AC drive
P3.1.3.2	Motor Torque Limit	0.0	300.0	%	300.0	1287	The maximum torque limit of the motoring side
P3.1.3.3	Generator Torque Limit	0.0	300.0	%	300.0	1288	The maximum torque limit of the generating side
P3.1.3.4	Motor Power Limit	0.0	300.0	%	300.0	1290	The maximum power limit of the motoring side
P3.1.3.5	Generator Power Limit	0.0	300.0	%	300.0	1289	The maximum power limit of the generating side

Table 34: Open loop settings

Index	Parameter	Min	Max	Unit	Default	ID	Description
P3.1.4.1 	U/f Ratio	0	2		0	108	The type of the U/f curve between zero frequency and the field weakening point. 0=Linear 1=Squared 2=Programmable
P3.1.4.2	Field Weakening Point Frequency	8.00	P3.3.1.2	Hz	Varies	602	The field weakening point is the output frequency at which the output voltage reaches the field weakening point voltage.
P3.1.4.3 	Voltage at Field Weakening Point	10.00	200.00	%	100.00	603	The voltage at the field weakening point as a percentage of the motor nominal voltage.
P3.1.4.4	U/f Midpoint Frequency	0.00	P3.1.4.2.	Hz	Varies	604	If the value of P3.1.4.1 is <i>programmable</i> , this parameter gives the middle point frequency of the curve.
P3.1.4.5	U/f Midpoint Voltage	0.0	100.0	%	100.0	605	If the value of P3.1.4.1 is <i>programmable</i> , this parameter gives the middle point voltage of the curve.
P3.1.4.6	Zero Frequency Voltage	0.00	40.00	%	Varies	606	This parameter gives the zero frequency voltage of the U/f curve. The default value is different for different unit sizes.

Table 34: Open loop settings

Index	Parameter	Min	Max	Unit	Default	ID	Description
P3.1.4.7 	Flying Start Options	0	63		0	1590	A checkbox selection B0 = Search the shaft frequency only from the same direction as the frequency reference B1 = Disable AC scanning B4 = Use the frequency reference for the initial guess B5 = Disable DC pulses
P3.1.4.8	Flying Start Scan Current	0.0	100.0	%	45.0	1610	As a percentage of the motor nominal current.
P3.1.4.9 	Auto Torque Boost	0	1		0	109	0=Disabled 1=Enabled
P3.1.4.10	Torque Boost Motor Gain	0.0	100.0	%	100.0	665	Scaling factor for the motoring side IR-compensation when the torque boost is used.
P3.1.4.11	Torque Boost Generator Gain	0.0	100.0	%	0.0	667	Scaling factor for the generating side IR-compensation when the torque boost is used.
M3.1.4.12	I/f Start	This menu includes 3 parameters. See the table below.					

Table 35: I/f start parameters







Index	Parameter	Min	Max	Unit	Default	ID	Description
P3.1.4.12.1 	I/f Start	0	1		0	534	0 = Disabled 1 = Enabled
P3.1.4.12.2 	I/f Start Frequency	5.0	0.5 * P3.1.1.2		0.2 * P3.1.1.2	535	The output frequency limit below which the set I/f start current is fed to motor.
P3.1.4.12.3 	I/f Start Current	0.0	100.0	%	80.0	536	The current that is fed to the motor when the I/f Start function is activated.

Table 36: Torque stabilator parameters

Index	Parameter	Min	Max	Unit	Default	ID	Description
P3.1.4.13.1 	Torque Stabilator Gain	0.0	500.0	%	50.0	1412	The gain of the torque stabilator in an open loop control operation.
P3.1.4.13.2 	Torque Stabilator Gain at Field Weakening Point	0.0	500.0	%	50.0	1414	The gain of the torque stabilator at field weakening point in an open loop control operation.
P3.1.4.13.3 	Torque Stabilator Damping Time Constant	0.0005	1.0000	s	0.0050	1413	The damping time constant of the torque stabilator.
P3.1.4.13.4 	Torque Stabilator Damping Time Constant (for PM motors)	0.0005	1.0000	s	0.0050	1735	The damping time constant of the torque stabilator for a PM motor.

5.2 GROUP 3.2: START/STOP SETUP

Table 37: Start/stop setup menu

Index	Parameter	Min	Max	Unit	Default	ID	Description
P3.2.1	Remote Control Place	0	1		0 *	172	The selection of the remote control place (start/stop). Use this to change back to remote control from Vacon Live, for example if the control panel is broken. 0 = I/O control 1 = Fieldbus control
P3.2.2	Local/Remote	0	1		0 *	211	Switch between the local and remote control places. 0 = Remote 1 = Local
P3.2.3	Keypad Stop Button	0	1		0	114	0 = The Stop button always enabled (Yes) 1 = Limited function of the Stop button (No)
P3.2.4	Start Function	0	1		0	505	0 = Ramping 1 = Flying start
P3.2.5 	Stop Function	0	1		0	506	0 = Coasting 1 = Ramping

Table 37: Start/stop setup menu

Index	Parameter	Min	Max	Unit	Default	ID	Description
P3.2.6 	I/O A Start/Stop Logic	0	4		2 *	300	<p>Logic = 0 Ctrl sgn 1 = Forward Ctrl sgn 2 = Backward</p> <p>Logic = 1 Ctrl sgn 1 = Forward (edge) Ctrl sgn 2 = Inverted Stop Ctrl sgn 3 = Bckwrđ (edge)</p> <p>Logic = 2 Ctrl sgn 1 = Forward (edge) Ctrl sgn 2 = Bckwrđ (edge)</p> <p>Logic = 3 Ctrl sgn 1 = Start Ctrl sgn 2 = Reverse</p> <p>Logic = 4 Ctrl sgn 1 = Start (edge) Ctrl sgn 2 = Reverse</p>
P3.2.7	I/O B Start/Stop Logic	0	4		2 *	363	See above.
P3.2.8	Fieldbus Start Logic	0	1		0	889	0 = A rising edge is necessary 1 = State
P3.2.9	Start Delay	0.000	60.000	s	0.000	524	The delay between the start command and the actual start of the drive.

Table 37: Start/stop setup menu

Index	Parameter	Min	Max	Unit	Default	ID	Description
P3.2.10	Remote to Local Function	0	2		2	181	The selection of copy settings when you go from Remote to Local (keypad) control. 0 = Keep Run 1 = Keep Run & Reference 2 = Stop

* = The selection of the application with parameter P1.2 Application gives the default value. See the default values in Chapter 11 Appendix 1.

5.3 GROUP 3.3: REFERENCES

Table 38: Frequency reference parameters

Index	Parameter	Min	Max	Unit	Default	ID	Description
P3.3.1.1	Minimum Frequency Reference	0.00	P3.3.1.2.	Hz	0.00	101	The minimum frequency reference
P3.3.1.2	Maximum Frequency Reference	P3.3.1.1.	320.00	Hz	50.00 / 60.00	102	The maximum frequency reference
P3.3.1.3	Positive Frequency Reference Limit	-320.0	320.0	Hz	320.00	1285	The final frequency reference limit for the positive direction.
P3.3.1.4	Negative Frequency Reference Limit	-320.0	320.0	Hz	-320.00	1286	The final frequency reference limit for the negative direction. Use this parameter for example to prevent the motor from running in the reverse direction.
P3.3.1.5	I/O Control Reference A Selection	0	19		5 *	117	<p>Selection of the reference source when the control place is I/O A.</p> <p>0 = Preset Frequency 1 = Keypad reference 2 = Fieldbus 3 = AI1 4 = AI2 5 = AI1+AI2 6 = PID reference 7 = Motor potentiometer 8 = Joystick reference 9 = Jogging reference 10 = Block Out.1 11 = Block Out.2 12 = Block Out.3 13 = Block Out.4 14 = Block Out.5 15 = Block Out.6 16 = Block Out.7 17 = Block Out.8 18 = Block Out.9 19 = Block Out.10</p> <p>The application that you set with parameter 1.2 gives the default value.</p>

Table 38: Frequency reference parameters

Index	Parameter	Min	Max	Unit	Default	ID	Description
P3.3.1.6	I/O Control Reference B Selection	0	9		4 *	131	Selection of the reference source when the control place is I/O B. See above. You can force the I/O B control place to be active only with a digital input (P3.5.1.7).
P3.3.1.7	Keypad Control Reference Selection	0	19		2 *	121	Selection of the reference source when the control place is keypad. 0 = Preset Frequency 0 1 = Keypad 2 = Fieldbus 3 = AI1 4 = AI2 5 = AI1+AI2 6 = PID reference 7 = Motor potentiometer 8 = Joystick 9 = Jogging reference 10 = Block Out.1 11 = Block Out.2 12 = Block Out.3 13 = Block Out.4 14 = Block Out.5 15 = Block Out.6 16 = Block Out.7 17 = Block Out.8 18 = Block Out.9 19 = Block Out.10
P3.3.1.8	Keypad Reference	P3.3.1.1	P3.3.1.2.	Hz	0.00	184	You can adjust the frequency reference on the keypad with this parameter.
P3.3.1.9	Keypad Direction	0	1		0	123	The rotation direction of the motor when the control place is keypad. 0 = Forward 1 = Reverse

Table 38: Frequency reference parameters

Index	Parameter	Min	Max	Unit	Default	ID	Description
P3.3.1.10	Fieldbus Control Reference Selection	0	19		3 *	122	Selection of the reference source when the control place is Fieldbus. 0 = Preset frequency 0 1 = Keypad 2 = Fieldbus 3 = AI1 4 = AI2 5 = AI1+AI2 6 = PID reference 7 = Motor potentiometer 8 = Joystick 9 = Jogging reference 10 = Block Out.1 11 = Block Out.2 12 = Block Out.3 13 = Block Out.4 14 = Block Out.5 15 = Block Out.6 16 = Block Out.7 17 = Block Out.8 18 = Block Out.9 19 = Block Out.10

* = The selection of the application with parameter P1.2 Application gives the default value. See the default values in Chapter 11 Appendix 1.

Table 39: Torque reference parameters

Index	Parameter	Min	Max	Unit	Default	ID	Description
P3.3.2.1	Torque Reference Selection	0	26		0 *	641	<p>The selection of torque reference. The torque reference is scaled between the values of P3.3.2.2. and P3.3.2.3.</p> <p>0 = Not used 1 = Keypad 2 = Joystick 3 = AI1 4 = AI2 5 = AI3 6 = AI4 7 = AI5 8 = AI6 9 = ProcessDataIn 1 10 = ProcessDataIn 2 11 = ProcessDataIn 3 12 = ProcessDataIn 4 13 = ProcessDataIn 5 14 = ProcessDataIn 6 15 = ProcessDataIn 7 16 = ProcessDataIn 8 17 = Block Out.1 18 = Block Out.2 19 = Block Out.3 20 = Block Out.4 21 = Block Out.5 22 = Block Out.6 23 = Block Out.7 24 = Block Out.8 25 = Block Out.9 26 = Block Out.10</p> <p>If you use a fieldbus protocol where the torque reference can be given in Nm units, you must set <i>ProcessDataIn1</i> as the value to this parameter.</p>
P3.3.2.2	 Torque Minimum Reference	-300.0	300.0	%	0.0	643	The torque reference that agrees to the minimum value of the reference signal.

Table 39: Torque reference parameters



Index	Parameter	Min	Max	Unit	Default	ID	Description
P3.3.2.3 	Torque Maximum Reference	-300.0	300.0	%	100.0	642	The torque reference that agrees to the maximum value of the reference signal. This value is used as the maximum torque reference for negative and positive values.
P3.3.2.4	Torque Reference Filter Time	0.00	300.00	s	0.00	1244	Gives the filtering time for the final torque reference.
P3.3.2.5	Torque Reference Dead Zone	0.0	300.0	%	0.0	1246	To ignore the small values around 0 of the torque reference, set this value to be bigger than 0. When the reference signal is between 0 and $0 \pm$ the value of this parameter, the torque reference is set to 0.
P3.3.2.6	Keypad Torque Reference	0.0	P3.3.2.3	%	0.0	1439	Used when P3.3.2.1. is set to 1. The value of this parameter is limited between P3.3.2.3. and P3.3.2.2.
P3.3.2.7 	Torque Control Frequency Limit	0	1		0	1278	The selection of the output frequency limit mode for the torque control. 0 = Pos/Neg frequency limits 1 = frequency reference
M3.3.2.8	Torque Control Open Loop	This menu includes 3 parameter. See table below.					

Table 40: Torque control Open Loop parameters

Index	Parameter	Min	Max	Unit	Default	ID	Description
P3.3.2.8.1	Open Loop Torque Control Minimum Frequency	0.0	P3.3.1.2	Hz	3.0	636	The output frequency limit below which the drive operates in the frequency control mode.
P3.3.2.8.2	Open Loop Torque Control P Gain	0.0	32000.0		0.01	639	Gives the P gain for the torque controller in the open loop control mode. The P Gain value 1.0 causes a 1 Hz change in the output frequency when the torque error is 1% of the motor nominal torque.
P3.3.2.8.3	Open Loop Torque Control I Gain	0.0	32000.0		2.0	640	Gives the I gain for the torque controller in the open loop control mode. The I Gain value 1.0 causes the integration to reach 1.0 Hz in 1 second when the torque error is 1% of the motor nominal torque.

Table 41: Preset frequency parameters











Index	Parameter	Min	Max	Unit	Default	ID	Description
P3.3.3.1 	Preset Frequency Mode	0	1		0 *	182	0 = Binary coded 1 = Number of inputs The number of preset speed digital inputs that are active define the preset frequency.
P3.3.3.2 	Preset Frequency 0	P3.3.1.1	P3.3.1.2	Hz	5.00	180	The basic preset frequency 0 when it is set with P3.3.1.5.
P3.3.3.3 	Preset Frequency 1	P3.3.1.1	P3.3.1.2	Hz	10.00 *	105	Make the selection with digital input Preset frequency selection 0 (P3.3.3.10).
P3.3.3.4 	Preset Frequency 2	P3.3.1.1	P3.3.1.2	Hz	15.00 *	106	Make the selection with digital input Preset frequency selection 1 (P3.3.3.11).
P3.3.3.5 	Preset Frequency 3	P3.3.1.1	P3.3.1.2	Hz	20.00 *	126	Make the selection with digital inputs Preset frequency selection 0 & 1.
P3.3.3.6 	Preset Frequency 4	P3.3.1.1	P3.3.1.2	Hz	25.00 *	127	Make the selection with digital input Preset frequency selection 2 (P3.3.3.12).
P3.3.3.7 	Preset Frequency 5	P3.3.1.1	P3.3.1.2	Hz	30.00 *	128	Make the selection with digital inputs Preset frequency selection 0 & 2.
P3.3.3.8 	Preset Frequency 6	P3.3.1.1	P3.3.1.2	Hz	40.00 *	129	Make the selection with digital inputs Preset frequency selection 1 & 2.
P3.3.3.9 	Preset Frequency 7	P3.3.1.1	P3.3.1.2	Hz	50.00 *	130	Make the selection with digital inputs Preset frequency selection 0 & 1 & 2.
P3.3.3.10 	Preset Frequency Selection 0				DigIN SlotA.4	419	A binary selector for Preset speeds (0-7). See parameters P3.3.3.2 to P3.3.3.9.

Table 41: Preset frequency parameters



Index	Parameter	Min	Max	Unit	Default	ID	Description
P3.3.3.11 	Preset Frequency Selection 1				DigIN SlotA.5	420	A binary selector for Preset speeds (0-7). See parameters P3.3.3.2 to P3.3.3.9.
P3.3.3.12 	Preset Frequency Selection 2				DigIN Slot0.1	421	A binary selector for Preset speeds (0-7). See parameters P3.3.3.2 to P3.3.3.9.

Table 42: Motor potentiometer parameters



Index	Parameter	Min	Max	Unit	Default	ID	Description
P3.3.4.1 	Motor Potentiometer UP				DigIN Slot0.1	418	FALSE = Not active TRUE = Active. The motor potentiometer reference INCREASES until the contact is opened.
P3.3.4.2 	Motor Potentiometer DOWN				DigIN Slot0.1	417	FALSE = Not active TRUE = Active. The motor potentiometer reference DECREASES until the contact is opened.
P3.3.4.3	Motor Potentiometer Ramp Time	0.1	500.0	Hz/s	10.0	331	The rate of change in the motor potentiometer reference when it is increased or decreased with P3.3.4.1. or P3.3.4.2.
P3.3.4.4 	Motor Potentiometer Reset	0	2		1	367	The reset logic for the motor potentiometer frequency reference. 0 = No reset 1 = Reset if stopped 2 = Reset if powered down

Table 43: Joystick control parameters

Index	Parameter	Min	Max	Unit	Default	ID	Description
P3.3.5.1 	Joystick Signal Selection	0	6		0	451	0 = Not Used 1 = AI1 (0-100%) 2 = AI2 (0-100%) 3 = AI3 (0-100%) 4 = AI4 (0-100%) 5 = AI5 (0-100%) 6 = AI6 (0-100%)
P3.3.5.2 	Joystick Dead Zone	0.0	20.0	%	2.0	384	When the reference is between 0 and 0 ± this parameter, the reference is set to 0.
P3.3.5.3 	Joystick Sleep Zone	0.0	20.0	%	0.0	385	The AC drive stops if the joystick reference stays in the sleep zone for longer than the sleep delay. 0 = Not used The Sleep function is available only if you use joystick to control the frequency reference.
P3.3.5.4 	Joystick Sleep Delay	0.00	300.00	s	0.00	386	The AC drive stops if the joystick reference stays in the sleep zone for longer than the sleep delay. The Sleep function is available only if you use joystick to control the frequency reference.

Table 44: Jogging parameters

Index	Parameter	Min	Max	Unit	Default	ID	Description
P3.3.6.1 	Enable DI Jogging	Varies	Varies		DigIN Slot0.1	532	Enables the Jogging function from digital inputs. Does not have an effect on the jogging from the fieldbus. It is possible to enable Jogging only when the drive is in STOP state.
P3.3.6.2 	Jogging Reference 1 Activation	Varies	Varies		DigIN Slot0.1	530	Connect to a digital input to activate P3.3.6.4. If the input is activated, the drive starts.
P3.3.6.3 	Jogging Reference 2 Activation	Varies	Varies		DigIN Slot0.1	531	Connect to a digital input to activate P3.3.6.5. If the input is activated, the drive starts.
P3.3.6.4 	Jogging Reference 1	-MaxRef	MaxRef	Hz	0.00	1239	Gives the frequency reference when Jogging Reference 1 is activated.
P3.3.6.5 	Jogging Reference 2	-MaxRef	MaxRef	Hz	0.00	1240	Gives the frequency reference when Jogging Reference 2 is activated.
P3.3.6.6	Jogging Ramp	0.1	300.0	s	10.0	1257	Gives the acceleration and deceleration times when the Jogging function is active.

* = The selection of the application with parameter P1.2 Application gives the default value. See the default values in Chapter 11 Appendix 1.

5.4 GROUP 3.4: RAMPS AND BRAKES SETUP

Table 45: Ramp 1 setup

Index	Parameter	Min	Max	Unit	Default	ID	Description
P3.4.1.1 	Ramp 1 Shape	0.0	100.0	%	0.0	500	You can make smoother the start and the end of the acceleration and deceleration ramps.
P3.4.1.2	Acceleration Time 1	0.1	300.0	s	5.0	103	Gives the time that is necessary for the output frequency to increase from zero frequency to maximum frequency.
P3.4.1.3	Deceleration Time 1	0.1	300.0	s	5.0	104	Gives the time that is necessary for the output frequency to decrease from maximum frequency to zero frequency.

Table 46: Ramp 2 setup

Index	Parameter	Min	Max	Unit	Default	ID	Description
P3.4.2.1 	Ramp 2 Shape	0.0	100.0	%	0.0	501	You can make smoother the start and the end of the acceleration and deceleration ramps.
P3.4.2.2	Acceleration Time 2	0.1	300.0	s	10.0	502	Gives the time that is necessary for the output frequency to increase from zero frequency to maximum frequency.
P3.4.2.3	Deceleration Time 2	0.1	300.0	s	10.0	503	Gives the time that is necessary for the output frequency to decrease from maximum frequency to zero frequency.
P3.4.2.4	Ramp 2 Selection	Varies	Varies		DigIN Slot0.1	408	The selection of the ramp 1 or 2. FALSE = Ramp 1 Shape, Acceleration Time 1 and Deceleration Time 1. TRUE = Ramp 2 Shape, Acceleration Time 2 and Deceleration Time 2.

Table 47: Start magnetisation parameters

Index	Parameter	Min	Max	Unit	Default	ID	Description
P3.4.3.1	Start Magnetising Current	0.00	IL	A	IH	517	Gives the DC current that is fed into the motor at the start. 0 = Disabled
P3.4.3.2	Start Magnetising Time	0.00	600.00	s	0.00	516	Gives the time during which the DC current is fed to the motor before the acceleration starts.

Table 48: DC brake parameters

Index	Parameter	Min	Max	Unit	Default	ID	Description
P3.4.4.1	DC Brake Current	0	IL	A	IH	507	Gives the current that is fed into the motor during DC braking. 0 = Disabled
P3.4.4.2	DC Braking Time at Stop	0.00	600.00	s	0.00	508	Tells if the braking is ON or OFF and gives the braking time when the motor stops.
P3.4.4.3	Frequency to Start DC Braking at Ramp Stop	0.10	10.00	Hz	1.50	515	The output frequency at which the DC braking starts.

Table 49: Flux braking parameters

Index	Parameter	Min	Max	Unit	Default	ID	Description
P3.4.5.1 	Flux Braking	0	1		0	520	0 = Disabled 1 = Enabled
P3.4.5.2	Flux Braking Current	0	IL	A	IH	519	Gives the current level for the flux braking.

5.5 GROUP 3.5: I/O CONFIGURATION

Table 50: Digital input settings

Index	Parameter	Default	ID	Description
P3.5.1.1	Control Signal 1 A	DigIN SlotA.1 *	403	Ctrl signal 1 when the control place is I/O A (FWD).
P3.5.1.2	Control Signal 2 A	DigIN SlotA.2 *	404	Ctrl signal 2 when the control place is I/O A (REV).
P3.5.1.3	Control Signal 3 A	DigIN Slot0.1	434	Ctrl signal 3 when the control place is I/O A.
P3.5.1.4	Control Signal 1 B	DigIN Slot0.1 *	423	Start signal 1 when the control place is I/O B.
P3.5.1.5	Control Signal 2 B	DigIN Slot0.1 *	424	Start signal 2 when the control place is I/O B.
P3.5.1.6	Control Signal 3 B	DigIN Slot0.1	435	Start signal 3 when the control place is I/O B.
P3.5.1.7	I/O B Control Force	DigIN Slot0.1 *	425	TRUE = Force the control place to I/O B.
P3.5.1.8	I/O B Reference Force	DigIN Slot0.1 *	343	TRUE = I/O reference B (P3.3.1.6) gives the frequency reference.
P3.5.1.9	Fieldbus Control Force	DigIN Slot0.1 *	411	Force the control to fieldbus.
P3.5.1.10	Keypad Control Force	DigIN Slot0.1 *	410	Force the control to keypad.
P3.5.1.11	External Fault Close	DigIN SlotA.3 *	405	FALSE = OK TRUE = External fault
P3.5.1.12	External Fault Open	DigIN Slot0.2	406	FALSE = External fault TRUE = OK
P3.5.1.13	Fault Reset Close	DigIN SlotA.6 *	414	TRUE = Resets all active faults.
P3.5.1.14	Fault Reset Open	DigIN Slot0.1	213	FALSE = Resets all active faults.
P3.5.1.15	Run Enable	DigIN Slot0.2	407	You can set the drive in Ready state, when this is ON.
P3.5.1.16 	Run Interlock 1	DigIN Slot0.2	1041	The drive can be ready, but the start is not possible when the interlock is on (Damper interlock).

Table 50: Digital input settings

Index	Parameter	Default	ID	Description
P3.5.1.17 	Run Interlock 2	DigIN Slot0.2	1042	As above.
P3.5.1.18	Motor Preheat ON	DigIN Slot0.1	1044	FALSE = No action. TRUE = Uses the DC current of the motor preheat in Stop state. Used when the value of P3.18.1 is 2.
P3.5.1.19	Ramp 2 Selection	DigIN Slot0.1 *	408	Switch between ramps 1 and 2. FALSE = Ramp 1 Shape, Acceleration Time 1 and Deceleration Time 1. TRUE = Ramp 2 Shape, Acceleration Time 2 and Deceleration Time 2.
P3.5.1.20	Acc/Dec Prohibit	DigIN Slot0.1	415	No acceleration or deceleration is possible until the contact is open.
P3.5.1.21	Preset Frequency Selection 0	DigIN SlotA.4 *	419	A binary selector for preset speeds (0-7). See <i>Table 41 Preset frequency parameters</i> .
P3.5.1.22	Preset Frequency Selection 1	DigIN SlotA.5 *	420	A binary selector for preset speeds (0-7). See <i>Table 41 Preset frequency parameters</i> .
P3.5.1.23	Preset Frequency Selection 2	DigIN Slot0.1 *	421	A binary selector for preset speeds (0-7). See <i>Table 41 Preset frequency parameters</i> .
P3.5.1.24	Motor Potentiometer UP	DigIN Slot0.1 *	418	FALSE = Not active TRUE = Active. The motor potentiometer reference INCREASES until the contact is open.
P3.5.1.25	Motor Potentiometer DOWN	DigIN Slot0.1 *	417	FALSE = Not active TRUE = Active. The motor potentiometer reference DECREASES until the contact is open.
P3.5.1.26	Quick Stop Activation	DigIN Slot0.2	1213	FALSE = Activated To configure these functions, see <i>Table 67 Quick stop settings</i> .



Table 50: Digital input settings

Index	Parameter	Default	ID	Description
P3.5.1.27	Timer 1	DigIN Slot0.1	447	The rising edge starts Timer 1 that was programmed in Group 3.12.
P3.5.1.28	Timer 2	DigIN Slot0.1	448	See above.
P3.5.1.29	Timer 3	DigIN Slot0.1	449	See above.
P3.5.1.30	PID1 Setpoint Boost	DigIN Slot0.1	1046	FALSE = No boost TRUE = Boost
P3.5.1.31	PID1 Select Setpoint	DigIN Slot0.1	1047	FALSE = Setpoint 1 TRUE = Setpoint 2
P3.5.1.32	External PID Start Signal	DigIN Slot0.2	1049	FALSE = PID2 in stop mode TRUE = PID2 regulating This parameter has no effect if the external PID controller is not enabled in Group 3.14.
P3.5.1.33	External PID Select Setpoint	DigIN Slot0.1	1048	FALSE = Setpoint 1 TRUE = Setpoint 2
P3.5.1.34	Motor 1 Interlock	DigIN Slot0.1	426	FALSE = Not active TRUE = Active <i>See Table 96 Multipump parameters.</i>
P3.5.1.35	Motor 2 Interlock	DigIN Slot0.1	427	FALSE = Not active TRUE = Active <i>See Table 96 Multipump parameters.</i>
P3.5.1.36	Motor 3 Interlock	DigIN Slot0.1	428	FALSE = Not active TRUE = Active <i>See Table 96 Multipump parameters.</i>
P3.5.1.37	Motor 4 Interlock	DigIN Slot0.1	429	FALSE = Not active TRUE = Active <i>See Table 96 Multipump parameters.</i>

Table 50: Digital input settings

Index	Parameter	Default	ID	Description
P3.5.1.38	Motor 5 Interlock	DigIN Slot0.1	430	FALSE = Not active TRUE = Active See Table 96 Multipump parameters.
P3.5.1.39	Motor 6 Interlock	DigIN Slot0.1	486	FALSE = Not active TRUE = Active See Table 96 Multipump parameters.
P3.5.1.40	Reset Maintenance Counter	DigIN Slot0.1	490	TRUE = Reset
P3.5.1.41	Enable DI Jogging	DigIN Slot0.1	532	Enables the Jogging function from digital inputs. Does not have an effect on the jogging from fieldbus.
P3.5.1.42	Jogging Reference 1 Activation	DigIN Slot0.1	530	Connect to a digital input to activate P3.3.6.4. NOTE! If the input is activated, the drive starts.
P3.5.1.43	Jogging Reference 2 Activation	DigIN Slot0.1	531	Connect to a digital input to activate P3.3.6.5. NOTE! If the input is activated, the drive starts.
P3.5.1.44	Mechanical Brake Feedback	DigIN Slot0.1	1210	Connect this input signal to the auxiliary contact of the mechanical brake. If the contact is not closed within the given time, the drive shows a fault.
P3.5.1.45	Fire Mode Activation OPEN	DigIN Slot0.2	1596	Activates the Fire mode if it is enabled with a correct password. FALSE = Fire Mode active TRUE = No action
P3.5.1.46	Fire Mode Activation CLOSE	DigIN Slot0.1	1619	Activates the Fire mode if it is enabled with a correct password. FALSE = No action TRUE = Fire Mode active

Table 50: Digital input settings

Index	Parameter	Default	ID	Description
P3.5.1.47	Fire Mode Reverse	DigIN Slot0.1	1618	Gives a command of reverse rotation direction during Fire mode. This function has no effect in normal operation. FALSE = Forward TRUE = Reverse
P3.5.1.48	Auto-cleaning Activation	DigIN Slot0.1	1715	Start the Auto-cleaning. The process stops if the activation signal is removed before the process is complete. NOTE! If the input is activated, the drive starts.
P3.5.1.49	 Parameter Set 1/2 Selection	DigIN Slot0.1	496	OPEN = Parameter set 1 CLOSED = Parameter set 2
P3.5.1.50	 User Defined Fault 1 Activation	DigIN Slot0.1	15523	OPEN = No action CLOSED = Fault activated
P3.5.1.51	 User Defined Fault 2 Activation	DigIN Slot0.1	15524	OPEN = No action CLOSED = Fault activated

**NOTE!**

Your option board and board setup gives the number of available analogue inputs. The standard I/O board has 2 analogue inputs.

* = The selection of the application with parameter P1.2 Application gives the default value. See the default values in Chapter 11 Appendix 1.

Table 51: Analogue input 1 settings

Index	Parameter	Min	Max	Unit	Default	ID	Description
P3.5.2.1.1	AI1 Signal Selection				AnIN SlotA.1	377	Connect the AI1 signal to the analogue input of your choice with this parameter. Programmable. See 9.7.1 Programming of digital and analogue inputs.
P3.5.2.1.2	 AI1 Signal Filter Time	0.00	300.00	s	0.1 *	378	The filter time for the analogue input.
P3.5.2.1.3	 AI1 Signal Range	0	1		0 *	379	0 = 0...10V / 0...20mA 1 = 2...10V / 4...20mA
P3.5.2.1.4	 AI1 Custom. Min	-160.00	160.00	%	0.00 *	380	The custom range minimum setting, 20% = 4-20 mA/2-10 V
P3.5.2.1.5	 AI1 Custom. Max	-160.00	160.00	%	100.00 *	381	The custom range maximum setting.
P3.5.2.1.6	 AI1 Signal Inversion	0	1		0 *	387	0 = Normal 1 = Signal inverted

Table 52: Analogue input 2 settings

Index	Parameter	Min	Max	Unit	Default	ID	Description
P3.5.2.2.1	AI2 Signal Selection				AnIN SlotA.2	388	See P3.5.2.1.1.
P3.5.2.2.2	AI2 Signal Filter Time	0.00	300.00	s	0.1 *	389	See P3.5.2.1.2.
P3.5.2.2.3	AI2 Signal Range	0	1		1 *	390	See P3.5.2.1.3.
P3.5.2.2.4	AI2 Custom. Min	-160.00	160.00	%	0.00 *	391	See P3.5.2.1.4.
P3.5.2.2.5	AI2 Custom. Max	-160.00	160.00	%	100.00 *	392	See P3.5.2.1.5.
P3.5.2.2.6	AI2 Signal Inversion	0	1		0 *	398	See P3.5.2.1.6.

Table 53: Analogue input 3 settings

Index	Parameter	Min	Max	Unit	Default	ID	Description
P3.5.2.3.1	AI3 Signal Selection				AnIN SlotD.1	141	See P3.5.2.1.1.
P3.5.2.3.2	AI3 Signal Filter Time	0.00	300.00	s	0.1	142	See P3.5.2.1.2.
P3.5.2.3.3	AI3 Signal Range	0	1		0	143	See P3.5.2.1.3.
P3.5.2.3.4	AI3 Custom. Min	-160.00	160.00	%	0.00	144	See P3.5.2.1.4.
P3.5.2.3.5	AI3 Custom. Max	-160.00	160.00	%	100.00	145	See P3.5.2.1.5.
P3.5.2.3.6	AI3 Signal Inversion	0	1		0	151	See P3.5.2.1.6.

Table 54: Analogue input 4 settings

Index	Parameter	Min	Max	Unit	Default	ID	Description
P3.5.2.4.1	AI4 Signal Selection				AnIN SlotD.2	152	See P3.5.2.1.1.
P3.5.2.4.2	AI4 Signal Filter Time	0.00	300.00	s	0.1	153	See P3.5.2.1.2.
P3.5.2.4.3	AI4 Signal Range	0	1		0	154	See P3.5.2.1.3.
P3.5.2.4.4	AI4 Custom. Min	-160.00	160.00	%	0.00	155	See P3.5.2.1.4.
P3.5.2.4.5	AI4 Custom. Max	-160.00	160.00	%	100.00	156	See P3.5.2.1.5.
P3.5.2.4.6	AI4 Signal Inversion	0	1		0	162	See P3.5.2.1.6.

Table 55: Analogue input 5 settings

Index	Parameter	Min	Max	Unit	Default	ID	Description
P3.5.2.5.1	AI5 Signal Selection				AnIN SlotE.1	188	See P3.5.2.1.1.
P3.5.2.5.2	AI5 Signal Filter Time	0.00	300.00	s	0.1	189	See P3.5.2.1.2.
P3.5.2.5.3	AI5 Signal Range	0	1		0	190	See P3.5.2.1.3.
P3.5.2.5.4	AI5 Custom. Min	-160.00	160.00	%	0.00	191	See P3.5.2.1.4.
P3.5.2.5.5	AI5 Custom. Max	-160.00	160.00	%	100.00	192	See P3.5.2.1.5.
P3.5.2.5.6	AI5 Signal Inversion	0	1		0	198	See P3.5.2.1.6.

Table 56: Analogue input 6 settings

Index	Parameter	Min	Max	Unit	Default	ID	Description
P3.5.2.6.1	AI6 Signal Selection				AnIN SlotE.2	199	See P3.5.2.1.1.
P3.5.2.6.2	AI6 Signal Filter Time	0.00	300.00	s	0.1	200	See P3.5.2.1.2.
P3.5.2.6.3	AI6 Signal Range	0	1		0	201	See P3.5.2.1.3.
P3.5.2.6.4	AI6 Custom. Min	-160.00	160.00	%	0.00	202	See P3.5.2.1.4.
P3.5.2.6.5	AI6 Custom. Max	-160.00	160.00	%	100.00	203	See P3.5.2.1.5.
P3.5.2.6.6	AI6 Signal Inversion	0	1		0	209	See P3.5.2.1.6.

Table 57: Digital output settings on standard I/O board

Index	Parameter	Min	Max	Unit	Default	ID	Description
P3.5.3.2.1 	Basic R01 Function	0	59		2 *	11001	<p>The function selection for Basic R01</p> <p>0 = None 1 = Ready 2 = Run 3 = General fault 4 = General fault inverted 5 = General alarm 6 = Reversed 7 = At speed 8 = Thermistor fault 9 = Motor regulator active 10 = Start signal active 11 = Keypad control active 12 = I/O B control activated 13 = Limit supervision 1 14 = Limit supervision 2 15 = Fire Mode active 16 = Jogging activated 17 = Preset speed active 18 = Quick stop activated 19 = PID in Sleep mode 20 = PID soft fill active 21 = PID feedback supervision (limits) 22 = Ext. PID supervision (limits) 23 = Input press. alarm/fault 24 = Frost prot. alarm/fault 25 = Motor 1 control 26 = Motor 2 control 27 = Motor 3 control 28 = Motor 4 control</p>

Table 57: Digital output settings on standard I/O board

Index	Parameter	Min	Max	Unit	Default	ID	Description
P3.5.3.2.1 	Basic R01 Function	0	59		2 *	11001	29 = Motor 5 control 30 = Motor 6 control 31 = Time Channel 1 32 = Time Channel 2 33 = Time Channel 3 34 = FB ControlWord B13 35 = FB ControlWord B14 36 = FB ControlWord B15 37 = FB ProcessData1.B0 38 = FB ProcessData1.B1 39 = FB ProcessData1.B2 40 = Maintenance alarm 41 = Maintenance fault 42 = Mechanical brake (Open brake command) 43 = Mech. brake inverted 44 = Block Out.1 45 = Block Out.2 46 = Block Out.3 47 = Block Out.4 48 = Block Out.5 49 = Block Out.6 50 = Block Out.7 51 = Block Out.8 52 = Block Out.9 53 = Block Out.10 54 = Jockey pump control 55 = Priming pump control 56 = Auto-cleaning active 57 = Motor Switch Open 58 = TEST (Always Closed) 59 = Motor preheat active
P3.5.3.2.2	Basic R01 ON Delay	0.00	320.00	s	0.00	11002	The ON delay for the relay.
P3.5.3.2.3	Basic R01 OFF Delay	0.00	320.00	s	0.00	11003	The OFF delay for the relay.

Table 57: Digital output settings on standard I/O board

Index	Parameter	Min	Max	Unit	Default	ID	Description
P3.5.3.2.4	Basic R02 Function	0	56		3 *	11004	See P3.5.3.2.1.
P3.5.3.2.5	Basic R02 ON Delay	0.00	320.00	s	0.00	11005	See M3.5.3.2.2.
P3.5.3.2.6	Basic R02 OFF Delay	0.00	320.00	s	0.00	11006	See M3.5.3.2.3.
P3.5.3.2.7	Basic R03 Function	0	56		1 *	11007	See P3.5.3.2.1. Not visible if only 2 output relays are installed.

* = The selection of the application with parameter P1.2 Application gives the default value. See the default values in Chapter 11 Appendix 1.

THE DIGITAL OUTPUTS OF THE EXPANDER SLOTS C, D AND E

Shows only the parameters for the outputs on option boards in slots C, D and E. Make the selections as in Basic R01 Function (P3.5.3.2.1).

This group or these parameters are not visible if there are no digital outputs in slots C, D or E.

Table 58: Standard I/O board analogue output settings

Index	Parameter	Min	Max	Unit	Default	ID	Description
P3.5.4.1.1 	A01 function	0	31		2 *	10050	0 = TEST 0% (Not used) 1 = TEST 100% 2 = Output freq (0 - fmax) 3 = Freq reference (0 - fmax) 4 = Motor speed (0 - Motor nominal speed) 5 = Output current (0 - InMotor) 6 = Motor torque (0 - TnMotor) 7 = Motor power (0 - PnMotor) 8 = Motor voltage (0 - UnMotor) 9 = DC link voltage (0 - 1000V) 10 = PID Setpoint (0-100%) 11 = PID Feedback (0-100%) 12 = PID1 output (0-100%) 13 = Ext.PID output (0-100%) 14 = ProcessDataIn1 (0-100%) 15 = ProcessDataIn2 (0-100%) 16 = ProcessDataIn3 (0-100%)

Table 58: Standard I/O board analogue output settings



Index	Parameter	Min	Max	Unit	Default	ID	Description
P3.5.4.1.1 	AO1 function	0	31		2 *	10050	17 = ProcessDataIn4 (0-100%) 18 = ProcessDataIn5 (0-100%) 19 = ProcessDataIn6 (0-100%) 20 = ProcessDataIn7 (0-100%) 21 = ProcessDataIn8 (0-100%) 22 = Block Out.1 (0-100%) 23 = Block Out.2 (0-100%) 24 = Block Out.3 (0-100%) 25 = Block Out.4 (0-100%) 26 = Block Out.5 (0-100%) 27 = Block Out.6 (0-100%) 28 = Block Out.7 (0-100%) 29 = Block Out.8 (0-100%) 30 = Block Out.9 (0-100%) 31 = Block Out.10 (0-100%)
P3.5.4.1.2	AO1 filter time	0.0	300.0	s	1.0 *	10051	The filter time of the analogue output signal. See P3.5.2.1.2. 0 = No filtering
P3.5.4.1.3	AO1 minimum	0	1		0 *	10052	0 = 0 mA / 0V 1 = 4 mA / 2V Make the selection of the signal type (current/voltage) with the dip switches. The analogue output scaling is different in P3.5.4.1.4. See also P3.5.2.1.3.

Table 58: Standard I/O board analogue output settings

Index	Parameter	Min	Max	Unit	Default	ID	Description
P3.5.4.1.4 	A01 minimum scale	Varies	Varies	Varies	0.0 *	10053	The minimum scale in process unit. Depends on the selection of the A01 function.
P3.5.4.1.5 	A01 maximum scale	Varies	Varies	Varies	0.0 *	10054	The maximum scale in process unit. Depends on the selection of the A01 function.

* = The selection of the application with parameter P1.2 Application gives the default value. See the default values in Chapter 11 Appendix 1.

THE ANALOGUE OUTPUTS OF THE EXPANDER SLOTS C, D AND E

Shows only the parameters for the outputs on option boards in slots C, D and E. Make the selections as in Basic A01 Function (P3.5.4.1.1).

This group or these parameters are not visible if there are no digital outputs in slots C, D or E.

5.6 GROUP 3.6: FIELDBUS DATA MAPPING

Table 59: Fieldbus data mapping

Index	Parameter	Min	Max	Unit	Default	ID	Description
P3.6.1	Fieldbus Data Out 1 Selection	0	35000		1	852	Make the selection of the data that is sent to fieldbus with the ID of the parameter or monitor. The data is scaled to an unsigned 16-bit format according to the format on the control panel. For example, 25.5 on the display agrees with 255.
P3.6.2	Fieldbus Data Out 2 Selection	0	35000		2	853	Make the selection of the Process Data Out with the parameter ID.
P3.6.3	Fieldbus Data Out 3 Selection	0	35000		3	854	Make the selection of the Process Data Out with the parameter ID.
P3.6.4	Fieldbus Data Out 4 Selection	0	35000		4	855	Make the selection of the Process Data Out with the parameter ID.
P3.6.5	Fieldbus Data Out 5 Selection	0	35000		5	856	Make the selection of the Process Data Out with the parameter ID.
P3.6.6	Fieldbus Data Out 6 Selection	0	35000		6	857	Make the selection of the Process Data Out with the parameter ID.
P3.6.7	Fieldbus Data Out 7 Selection	0	35000		7	858	Make the selection of the Process Data Out with the parameter ID.
P3.6.8	Fieldbus Data Out 8 Selection	0	35000		37	859	Make the selection of the Process Data Out with the parameter ID.







Table 60: The default values for Process Data Out in fieldbus

Data	Default value	Scale
Process Data Out 1	Output frequency	0.01 Hz
Process Data Out 2	Motor speed	1 rpm
Process Data Out 3	Motor current	0.1 A
Process Data Out 4	Motor torque	0.1%
Process Data Out 5	Motor power	0.1%
Process Data Out 6	Motor voltage	0.1 V
Process Data Out 7	DC link voltage	1 V
Process Data Out 8	Last active fault code	1

For example, the value 2500 for Output frequency agrees with 25.00 Hz, because the scale is 0.01. All the monitoring values that you can find in Chapter 4.1 *Monitor group* are given the scale value.

5.7 GROUP 3.7: PROHIBIT FREQUENCIES

Table 61: Prohibit frequencies

Index	Parameter	Min	Max	Unit	Default	ID	Description
P3.7.1 	Prohibit Frequency Range 1 Low Limit	-1.00	320.00	Hz	0.00	509	0 = Not used
P3.7.2 	Prohibit Frequency Range 1 High Limit	0.00	320.00	Hz	0.00	510	0 = Not used
P3.7.3 	Prohibit Frequency Range 2 Low Limit	0.00	320.00	Hz	0.00	511	0 = Not used
P3.7.4 	Prohibit Frequency Range 2 High Limit	0.00	320.00	Hz	0.00	512	0 = Not used
P3.7.5 	Prohibit Frequency Range 3 Low Limit	0.00	320.00	Hz	0.00	513	0 = Not used
P3.7.6 	Prohibit Frequency Range 3 High Limit	0.00	320.00	Hz	0.00	514	0 = Not used
P3.7.7 	Ramp Time Factor	0.1	10.0	Times	1.0	518	A multiplier of the set ramp time between prohibit frequency limits.

5.8 GROUP 3.8: SUPERVISIONS

Table 62: Supervision settings

Index	Parameter	Min	Max	Unit	Default	ID	Description
P3.8.1	Supervision #1 Item Selection	0	17		0	1431	0 = Output frequency 1 = Frequency reference 2 = Motor current 3 = Motor torque 4 = Motor power 5 = DC-link voltage 6 = Analogue input 1 7 = Analogue input 2 8 = Analogue input 3 9 = Analogue input 4 10 = Analogue input 5 11 = Analogue input 6 12 = Temperature input 1 13 = Temperature input 2 14 = Temperature input 3 15 = Temperature input 4 16 = Temperature input 5 17 = Temperature input 6
P3.8.2	Supervision #1 Mode	0	2		0	1432	0 = Not used 1 = Low limit supervision (output active under limit) 2 = High limit supervision (output active over limit)
P3.8.3	Supervision #1 Limit	-50.00	50.00	Varies	25.00	1433	The supervision limit for the set item. The unit shows automatically.
P3.8.4	Supervision #1 Limit Hysteresis	0.00	50.00	Varies	5.00	1434	The supervision limit hysteresis for the set item. The unit is set automatically.
P3.8.5	Supervision #2 Item Selection	0	17		1	1435	See P3.8.1
P3.8.6	Supervision #2 Mode	0	2		0	1436	See P3.8.2
P3.8.7	Supervision #2 Limit	-50.00	50.00	Varies	40.00	1437	See P3.8.3
P3.8.8	Supervision #2 Limit Hysteresis	0.00	50.00	Varies	5.00	1438	See P3.8.4

5.9 GROUP 3.9: PROTECTIONS

Table 63: General protections settings

Index	Parameter	Min	Max	Unit	Default	ID	Description
P3.9.1.2 	Response to External Fault	0	3		2	701	0 = No action 1 = Alarm 2 = Fault (Stop according to stop function) 3 = Fault (Stop by coasting)
P3.9.1.3	Input Phase Fault	0	1		0	730	0 = 3-phase support 1 = 1-phase support If you use the 1-phase supply, the value must be 1-phase support.
P3.9.1.4	Undervoltage Fault	0	1		0	727	0 = Fault stored in history 1 = Fault not stored in history
P3.9.1.5	Response to Output Phase Fault	0	3		2	702	See P3.9.1.2.
P3.9.1.6	Response to Fieldbus Communication Fault	0	5		3	733	0 = No action 1 = Alarm 2 = Alarm + preset fault frequency (P3.9.1.12) 3 = Fault (Stop according to stop function) 4 = Fault (Stop by coasting)
P3.9.1.7	Slot Communication Fault	0	3		2	734	See P3.9.1.2.
P3.9.1.8	Thermistor Fault	0	3		0	732	See P3.9.1.2.
P3.9.1.9	PID Soft Fill Fault	0	3		2	748	See P3.9.1.2.
P3.9.1.10	Response to PID Supervision Fault	0	3		2	749	See P3.9.1.2.
P3.9.1.11	Response to External PID Supervision Fault	0	3		2	757	See P3.9.1.2.

Table 63: General protections settings

Index	Parameter	Min	Max	Unit	Default	ID	Description
P3.9.1.12	Earth Fault	0	3		3	703	See P3.9.1.2. You can configure this fault only in frames MR7, MR8, and MR9.
P3.9.1.13	Preset Alarm Frequency	P3.3.1.1	P3.3.1.2	Hz	25.00	183	Used when the fault response (in Group 3.9 Protections) is Alarm + preset frequency.
P3.9.1.14 	Response to Safe Torque Off (STO) Fault	0	3		3	775	See P3.9.1.2.

Table 64: Motor thermal protection settings



Index	Parameter	Min	Max	Unit	Default	ID	Description
P3.9.2.1	Motor Thermal Protection	0	3		2	704	<p>0 = No action 1 = Alarm 2 = Fault (Stop according to stop mode) 3 = Fault (Stop by coasting)</p> <p>If you have a motor thermistor, use it to protect the motor. Set the value to be 0.</p>
P3.9.2.2	Ambient Temperature	-20.0	100.0	°C	40.0	705	The ambient temperature in °C.
P3.9.2.3 	Zero Speed Cooling Factor	5.0	150.0	%	Varies	706	Gives the cooling factor at zero speed in relation to the point where the motor operates at nominal speed without an external cooling.
P3.9.2.4 	Motor Thermal Time Constant	1	200	min	Varies	707	The time constant is the time within which the calculated thermal stage has reached 63% of its final value.
P3.9.2.5 	Motor Thermal Loadability	10	150	%	100	708	

Table 65: Motor stall protection settings



Index	Parameter	Min	Max	Unit	Default	ID	Description
P3.9.3.1	Motor Stall Fault	0	3		0	709	0 = No action 1 = Alarm 2 = Fault (Stop according to stop mode) 3 = Fault (Stop by coasting)
P3.9.3.2 	Stall Current	0.00	5.2	A	3.7	710	For a stall state to occur, the current must be above this limit.
P3.9.3.3 	Stall Time Limit	1.00	120.00	s	15.00	711	This is the maximum time for a stall state.
P3.9.3.4	Stall Frequency Limit	1.00	P3.3.1.2	Hz	25.00	712	For a stall state to occur, the output frequency must be below this limit for a certain time.

Table 66: Motor underload protection settings



Index	Parameter	Min	Max	Unit	Default	ID	Description
P3.9.4.1	Underload Fault	0	3		0	713	0 = No action 1 = Alarm 2 = Fault (Stop according to stop mode) 3 = Fault (Stop by coasting)
P3.9.4.2 	Underload Protection: Field Weakening Area Load	10.0	150.0	%	50.0	714	Gives the value for the minimum torque that is possible when the output frequency is bigger than the field weakening point.
P3.9.4.3	Underload Protection: Zero Frequency Load	5.0	150.0	%	10.0	715	Gives the value for the minimum torque that is possible with zero frequency. If you change the value of parameter P3.1.1.4, this parameter is automatically restored to the default value.
P3.9.4.4 	Underload Protection: Time Limit	2.00	600.00	s	20.00	716	This is the maximum time for an underload state.

Table 67: Quick stop settings





Index	Parameter	Min	Max	Unit	Default	ID	Description
P3.9.5.1 	Quick Stop Mode	0	2		1	1276	How the drive stops when the Quick stop function is activated from DI or fieldbus. 0 = Coasting 1 = Quick stop deceleration time 2 = Stop according to Stop function (P3.2.5)
P3.9.5.2 	Quick Stop Activation	Varies	Varies		DigIN Slot0.2	1213	FALSE = Activated
P3.9.5.3 	Quick Stop Deceleration Time	0.1	300.0	s	3.0	1256	
P3.9.5.4 	Response to Quick Stop Fault	0	2		1	744	0 = No action 1 = Alarm 2 = Fault (Stop according to Quick stop mode)

Table 68: Temperature input fault 1 settings

Index	Parameter	Min	Max	Unit	Default	ID	Description
P3.9.6.1	Temperature Signal 1	0	63		0	739	<p>Selection of signals to use for alarm and fault triggering.</p> <p>B0 = Temperature Signal 1 B1 = Temperature Signal 2 B2 = Temperature Signal 3 B3 = Temperature Signal 4 B4 = Temperature Signal 5 B5 = Temperature Signal 6</p> <p>The maximum value is taken from the set signals and used for alarm and fault triggering.</p> <p>NOTE!</p> <p>Only the 6 first temperature inputs are supported (the boards from slot A to slot E).</p>
P3.9.6.2	Alarm Limit 1	-30.0	200.0	°C	120.0	741	<p>The temperature limit for an alarm.</p> <p>NOTE!</p> <p>Only the inputs that are set with parameter P3.9.6.1 are compared.</p>
P3.9.6.3	Fault Limit 1	-30.0	200.0	°C	120.0	742	<p>The temperature limit for an alarm.</p> <p>NOTE!</p> <p>Only the inputs that are set with parameter P3.9.6.1 are compared.</p>

Table 68: Temperature input fault 1 settings

Index	Parameter	Min	Max	Unit	Default	ID	Description
P3.9.6.4	Fault Limit Response 1	0	3		2	740	0 = No response 1 = Alarm 2 = Fault (Stop according to stop mode) 3 = Fault (Stop by coasting)

Table 69: Temperature input fault 2 settings

Index	Parameter	Min	Max	Unit	Default	ID	Description
P3.9.6.5	Temperature Signal 2	0	63		0	763	<p>The selection of signals to use for alarm and fault triggering.</p> <p>B0 = Temperature Signal 1 B1 = Temperature Signal 2 B2 = Temperature Signal 3 B3 = Temperature Signal 4 B4 = Temperature Signal 5 B5 = Temperature Signal 6</p> <p>The maximum value is taken from the set signals and used for alarm and fault triggering.</p> <p>NOTE!</p> <p>Only the 6 first temperature inputs are supported (the boards from slot A to slot E).</p>
P3.9.6.6	Alarm Limit 2	-30.0	200.0	°C	120.0	764	<p>The temperature limit for an alarm.</p> <p>NOTE!</p> <p>Only the inputs that are set with parameter P3.9.6.5 are compared.</p>
P3.9.6.7	Fault Limit 2	-30.0	200.0	°C	120.0	765	<p>The temperature limit for an alarm.</p> <p>NOTE!</p> <p>Only the inputs that are set with parameter P3.9.6.5 are compared.</p>

Table 69: Temperature input fault 2 settings

Index	Parameter	Min	Max	Unit	Default	ID	Description
P3.9.6.8	Fault Limit Response 2	0	3		2	766	0 = No response 1 = Alarm 2 = Fault (Stop according to stop mode) 3 = Fault (Stop by coasting)

Table 70: AI low protection settings





Index	Parameter	Min	Max	Unit	Default	ID	Description
P3.9.8.1 	Analogue Input Low Protection	0	2			767	0 = No protection 1 = Protection enabled in Run state 2 = Protection enabled in Run and Stop state
P3.9.8.2 	Analogue Input Low Fault	0	5		0	700	0 = No action 1 = Alarm 2 = Alarm + preset fault frequency (P3.9.1.13) 3 = Alarm + previous frequency reference 4 = Fault (Stop according to stop mode) 5 = Fault (Stop by coasting)

Table 71: User-defined fault parameters

Index	Parameter	Min	Max	Unit	Default	ID	Description
P3.9.9.1	User Defined Fault 1 Activation				DigIN Slot0.1	15523	OPEN = No action CLOSED = Fault activated
P3.9.9.2 	Response to User Defined Fault 1	0	3		3	15525	0 = No action 1 = Alarm 2 = Fault (Stop according to stop mode) 3 = Fault (Stop by coasting)
P3.9.10.1	User Defined Fault 2 Activation				DigIN Slot0.1	15524	OPEN = No action CLOSED = Fault activated
P3.9.10.2 	Response to User Defined Fault 2	0	3		3	15526	See P3.9.9.2

5.10 GROUP 3.10: AUTOMATIC RESET

Table 72: Autoreset settings





Index	Parameter	Min	Max	Unit	Default	ID	Description
P3.10.1 	Automatic Reset	0	1		0	731	0 = Disabled 1 = Enabled
P3.10.2	Restart Function	0	1		1	719	The selection of the start mode for Automatic reset. 0 = Flying start 1 = According to P3.2.4.
P3.10.3 	Wait Time	0.10	10000.0 0	s	0.50	717	The wait time before the first reset is done.
P3.10.4 	Trial Time	0.00	10000.0 0	s	60.00	718	When the trial time is over, and the fault is still active, the drive will trip.
P3.10.5 	Number of Trials	1	10		4	759	The total quantity of trials. The fault type does not have an effect on it. If the drive is not able to be reset with the quantity of trials and the set trial time, a fault shows.
P3.10.6	Autoreset: Undervoltage	0	1		1	720	Autoreset permitted? 0 = No 1 = Yes
P3.10.7	Autoreset: Overvoltage	0	1		1	721	Autoreset permitted? 0 = No 1 = Yes
P3.10.8	Autoreset: Overcurrent	0	1		1	722	Autoreset permitted? 0 = No 1 = Yes

Table 72: Autoreset settings

Index	Parameter	Min	Max	Unit	Default	ID	Description
P3.10.9	Autoreset: AI Low	0	1		1	723	Autoreset permitted? 0 = No 1 = Yes
P3.10.10	Autoreset: Unit Overtemperature	0	1		1	724	Autoreset permitted? 0 = No 1 = Yes
P3.10.11	Autoreset: Motor Overtemperature	0	1		1	725	Autoreset permitted? 0 = No 1 = Yes
P3.10.12	Autoreset: External Fault	0	1		0	726	Autoreset permitted? 0 = No 1 = Yes
P3.10.13	Autoreset: Underload Fault	0	1		0	738	Autoreset permitted? 0 = No 1 = Yes
P3.10.14	Autoreset: PID Supervision Fault	0	1		0	776	Autoreset permitted? 0 = No 1 = Yes
P3.10.15	Autoreset: Ext PID Supervision Fault	0	1		0	777	Autoreset permitted? 0 = No 1 = Yes

5.11 GROUP 3.11: APPLICATION SETTINGS

Table 73: Application settings

Index	Parameter	Min	Max	Unit	Default	ID	Description
P3.11.1	Password	0	9999		0	1806	The password of the administrator.
P3.11.2	C/F Selection	0	1		0 *	1197	0 = Celsius 1 = Fahrenheit The system shows all the temperature-related parameters and monitoring values in the set unit.
P3.11.3	kW/hp Selection	0	1		0 *	1198	0 = kW 1 = hp The system shows all the power-related parameters and monitoring values in the set unit.
P3.11.4	Multimonitor View	0	2		1	1196	The division of the display of the control panel into sections in the multimonitor view. 0 = 2x2 sections 1 = 3x2 sections 2 = 3x3 sections
P3.11.5	FUNCT Button Configuration	0	15		15	1195	The values that you set with this parameter will be available when you push the FUNCT button on the keypad. B0 = Local / Remote B1 = Control Page B2 = Change Direction B3 = Quick Edit

* = The default value in the US is 1.

5.12 GROUP 3.12: TIMER FUNCTIONS

Table 74: Interval 1

Index	Parameter	Min	Max	Unit	Default	ID	Description
P3.12.1.1	ON Time	00:00:00	23:59:59	hh:mm:ss	00:00:00	1464	The ON time
P3.12.1.2	OFF Time	00:00:00	23:59:59	hh:mm:ss	00:00:00	1465	The OFF time
P3.12.1.3	Days					1466	The days of the week when a function is active. A checkbox selection B0 = Sunday B1 = Monday B2 = Tuesday B3 = Wednesday B4 = Thursday B5 = Friday B6 = Saturday
P3.12.1.4	Assign to Channel					1468	The selection of the time channel. A checkbox selection B0 = Time channel 1 B1 = Time channel 2 B2 = Time channel 3

Table 75: Interval 2

Index	Parameter	Min	Max	Unit	Default	ID	Description
P3.12.2.1	ON Time	00:00:00	23:59:59	hh:mm:ss	00:00:00	1469	See Interval 1.
P3.12.2.2	OFF Time	00:00:00	23:59:59	hh:mm:ss	00:00:00	1470	See Interval 1.
P3.12.2.3	Days					1471	See Interval 1.
P3.12.2.4	Assign to Channel					1473	See Interval 1.

Table 76: Interval 3

Index	Parameter	Min	Max	Unit	Default	ID	Description
P3.12.3.1	ON Time	00:00:00	23:59:59	hh:mm:ss	00:00:00	1474	See Interval 1.
P3.12.3.2	OFF Time	00:00:00	23:59:59	hh:mm:ss	00:00:00	1475	See Interval 1.
P3.12.3.3	Days					1476	See Interval 1.
P3.12.3.4	Assign to Channel					1478	See Interval 1.

Table 77: Interval 4

Index	Parameter	Min	Max	Unit	Default	ID	Description
P3.12.4.1	ON Time	00:00:00	23:59:59	hh:mm:ss	00:00:00	1479	See Interval 1.
P3.12.4.2	OFF Time	00:00:00	23:59:59	hh:mm:ss	00:00:00	1480	See Interval 1.
P3.12.4.3	Days					1481	See Interval 1.
P3.12.4.4	Assign to Channel					1483	See Interval 1.

Table 78: Interval 5

Index	Parameter	Min	Max	Unit	Default	ID	Description
P3.12.5.1	ON Time	00:00:00	23:59:59	hh:mm:ss	00:00:00	1484	See Interval 1.
P3.12.5.2	OFF Time	00:00:00	23:59:59	hh:mm:ss	00:00:00	1485	See Interval 1.
P3.12.5.3	Days					1486	See Interval 1.
P3.12.5.4	Assign to Channel					1488	See Interval 1.

Table 79: Timer 1

Index	Parameter	Min	Max	Unit	Default	ID	Description
P3.12.6.1	Duration	0	72000	s	0	1489	The time that the timer runs when it is activated by DI.
P3.12.6.2	Timer 1				DigINSlot 0.1	447	The rising edge starts Timer 1 that is programmed in Group 3.12.
P3.12.6.3	Assign to Channel					1490	The selection of the time channel. A checkbox selection B0 = Time channel 1 B1 = Time channel 2 B2 = Time channel 3

Table 80: Timer 2

Index	Parameter	Min	Max	Unit	Default	ID	Description
P3.12.7.1	Duration	0	72000	s	0	1491	See Timer 1.
P3.12.7.2	Timer 2				DigINSlot 0.1	448	See Timer 1.
P3.12.7.3	Assign to Channel					1492	See Timer 1.

Table 81: Timer 3

Index	Parameter	Min	Max	Unit	Default	ID	Description
P3.12.8.1	Duration	0	72000	s	0	1493	See Timer 1.
P3.12.8.2	Timer 3				DigINSlot 0.1	449	See Timer 1.
P3.12.8.3	Assign to Channel					1494	See Timer 1.

5.13 GROUP 3.13: PID CONTROLLER

Table 82: PID controller basic settings

Index	Parameter	Min	Max	Unit	Default	ID	Description
P3.13.1.1	PID Gain	0.00	1000.00	%	100.00	118	If the value of the parameter is set to 100%, a change of 10% in the error value causes the controller output to change by 10%.
P3.13.1.2	PID Integration Time	0.00	600.00	s	1.00	119	If this parameter is set to 1,00 s, a change of 10% in the error value causes the controller output to change by 10.00%/s.
P3.13.1.3	PID Derivation Time	0.00	100.00	s	0.00	132	If this parameter is set to 1,00 s, a change of 10% in the error value during 1.00 s causes the controller output to change by 10.00%.
P3.13.1.4	Process Unit Selection	1	38		1	1036	Make a selection of the unit for the actual value.
P3.13.1.5	Process Unit Min	Varies	Varies	Varies	0	1033	The value in process units at a 0% feedback or setpoint. This scaling is done for monitoring purposes only. The PID controller still uses the percentage internally for feedbacks and setpoints.
P3.13.1.6	Process Unit Max	Varies	Varies	Varies	100	1034	See above.
P3.13.1.7	Process Unit Decimals	0	4		2	1035	The quantity of decimals of the process unit value.
P3.13.1.8	Error Inversion	0	1		0	340	0 = Normal (Feedback < Setpoint -> Increase PID output) 1 = Inverted (Feedback < Setpoint -> Decrease PID output)

Table 82: PID controller basic settings



Index	Parameter	Min	Max	Unit	Default	ID	Description
P3.13.1.9 	Dead Band	Varies	Varies	Varies	0	1056	The dead band area around the setpoint in process units. The PID output is locked if the feedback stays within the dead band area for the set time.
P3.13.1.10 	Dead Band Delay	0.00	320.00	s	0.00	1057	If the feedback stays in the dead band area for the set time, the output is locked.

Table 83: Setpoint settings

Index	Parameter	Min	Max	Unit	Default	ID	Description
P3.13.2.1	Keypad setpoint 1	Varies	Varies	Varies	0	167	
P3.13.2.2	Keypad setpoint 2	Varies	Varies	Varies	0	168	
P3.13.2.3	Setpoint ramp time	0.00	300.0	s	0.00	1068	Gives the rising and falling ramp times for the setpoint changes. That is, the time to change from the minimum to the maximum.
P3.13.2.4	PID setpoint boost activation	Varies	Varies		DigIN Slot0.1	1046	FALSE = No boost TRUE = Boost
P3.13.2.5	PID select setpoint	Varies	Varies		DigIN Slot0.1	1047	FALSE = Setpoint 1 TRUE = Setpoint 2

Table 83: Setpoint settings

Index	Parameter	Min	Max	Unit	Default	ID	Description
P3.13.2.6	Setpoint source 1 selection	0	32		3 *	332	<p>0 = Not used 1 = Keypad setpoint 1 2 = Keypad setpoint 2 3 = AI1 4 = AI2 5 = AI3 6 = AI4 7 = AI5 8 = AI6 9 = ProcessDataIn1 10 = ProcessDataIn2 11 = ProcessDataIn3 12 = ProcessDataIn4 13 = ProcessDataIn5 14 = ProcessDataIn6 15 = ProcessDataIn7 16 = ProcessDataIn8 17 = Temperature input 1 18 = Temperature input 2 19 = Temperature input 3 20 = Temperature input 4 21 = Temperature input 5 22 = Temperature input 6 23 = Block Out.1 24 = Block Out.2 25 = Block Out.3 26 = Block Out.4 27 = Block Out.5 28 = Block Out.6 29 = Block Out.7 30 = Block Out.8 31 = Block Out.9 32 = Block Out.10</p> <p>The AIs and the ProcessDataIn are handled as percentages (0.00-100.00%) and scaled according to the setpoint minimum and maximum.</p> <p>NOTE!</p> <p>The ProcessDataIn signals use 2 decimals. If you set temperature inputs, you must set the setpoint minimum and maximum scaling parameters between -50 and 200 °C.</p>

Table 83: Setpoint settings

Index	Parameter	Min	Max	Unit	Default	ID	Description
P3.13.2.7	Setpoint 1 minimum	-200.00	200.00	%	0.00	1069	The minimum value at the analogue signal minimum.
P3.13.2.8	Setpoint 1 maximum	-200.00	200.00	%	100.00	1070	The maximum value at the analogue signal maximum.
P3.13.2.9	Setpoint 1 boost	-2.0	2.0	x	1.0	1071	It is possible to boost the setpoint with a digital input.
P3.13.2.10	Setpoint source 2 selection	0	22		2	431	See P3.13.2.6.
P3.13.2.11	Setpoint 2 minimum	-200.00	200.00	%	0.00	1073	The minimum value at the analogue signal minimum.
P3.13.2.12	Setpoint 2 maximum	-200.00	200.00	%	100.00	1074	The maximum value at the analogue signal maximum.
P3.13.2.13	Setpoint 2 boost	-2.0	2.0	x	1.0	1078	See P3.13.2.10.

* = The selection of the application with parameter P1.2 Application gives the default value. See the default values in Chapter 11 Appendix 1.

Table 84: Feedback settings

Index	Parameter	Min	Max	Unit	Default	ID	Description
P3.13.3.1	Feedback Function	1	9		1 *	333	1 = Only Source1 in use 2 = SQRT(Source1); (Flow=Constant x SQRT(Pressure)) 3 = SQRT(Source1- Source 2) 4 = SQRT(Source 1) + SQRT (Source 2) 5 = Source 1 + Source 2 6 = Source 1 - Source 2 7 = MIN (Source 1, Source 2) 8 = MAX (Source 1, Source 2) 9 = MEAN (Source 1, Source 2)
P3.13.3.2	Feedback Function Gain	-1000.0	1000.0	%	100.0	1058	Used for example with the value 2 in Feedback Function.

Table 84: Feedback settings

Index	Parameter	Min	Max	Unit	Default	ID	Description
P3.13.3.3	Feedback 1 Source Selection	0	30		2 *	334	<p>0 = Not used 1 = AI1 2 = AI2 3 = AI3 4 = AI4 5 = AI5 6 = AI6 7 = ProcessDataIn1 8 = ProcessDataIn2 9 = ProcessDataIn3 10 = ProcessDataIn4 11 = ProcessDataIn5 12 = ProcessDataIn6 13 = ProcessDataIn7 14 = ProcessDataIn8 15 = Temperature input 1 16 = Temperature input 2 17 = Temperature input 3 18 = Temperature input 4 19 = Temperature input 5 20 = Temperature input 6 21 = Block Out.1 22 = Block Out.2 23 = Block Out.3 24 = Block Out.4 25 = Block Out.5 26 = Block Out.6 27 = Block Out.7 28 = Block Out.8 29 = Block Out.9 30 = Block Out.10</p> <p>The AIs and the ProcessDataIn are handled as percentage (0.00-100.00%) and scaled according to Feedback minimum and maximum.</p> <p>NOTE!</p> <p>The ProcessDataIn signals use 2 decimals. If you set temperature inputs, you must set the setpoint minimum and maximum scaling parameters between -50 and 200 °C.</p>
P3.13.3.4	Feedback 1 Minimum	-200.00	200.00	%	0.00	336	The minimum value at the analogue signal minimum.

Table 84: Feedback settings

Index	Parameter	Min	Max	Unit	Default	ID	Description
P3.13.3.5	Feedback 1 Maximum	-200.00	200.00	%	100.00	337	The maximum value at the analogue signal maximum.
P3.13.3.6	Feedback 2 Source Selection	0	20		0	335	See P3.13.3.3.
P3.13.3.7	Feedback 2 Minimum	-200.00	200.00	%	0.00	338	The minimum value at the analogue signal minimum.
M3.13.3.8	Feedback 2 Maximum	-200.00	200.00	%	100.00	339	The maximum value at the analogue signal maximum.

* = The selection of the application with parameter P1.2 Application gives the default value. See the default values in Chapter 11 Appendix 1.

Table 85: Feedforward settings

Index	Parameter	Min	Max	Unit	Default	ID	Description
P3.13.4.1 	Feedforward Function	1	9		1	1059	See P3.13.3.1
P3.13.4.2	Feedforward Function Gain	-1000	1000	%	100.0	1060	See P3.13.3.2
P3.13.4.3	Feedforward 1 Source Selection	0	25		0	1061	See P3.13.3.3
P3.13.4.4	Feedforward 1 Minimum	-200.00	200.00	%	0.00	1062	See P3.13.3.4
P3.13.4.5	Feedforward 1 Maximum	-200.00	200.00	%	100.00	1063	See P3.13.3.5
P3.13.4.6	Feedforward 2 Source Selection	0	25		0	1064	See P3.13.3.6
P3.13.4.7	Feedforward 2 Min	-200.00	200.00	%	0.00	1065	See P3.13.3.7
P3.13.4.8	Feedforward 2 Max	-200.00	200.00	%	100.00	1066	See M3.13.3.8

Table 86: Sleep function settings









Index	Parameter	Min	Max	Unit	Default	ID	Description
P3.13.5.1 	SP1 Sleep Frequency	0.00	320.00	Hz	0.00	1016	The drive goes to sleep mode when the output frequency stays below this limit for a longer time than set by SP1 Sleep Delay.
P3.13.5.2 	SP1 Sleep Delay	0	300	s	0	1017	The minimum quantity of time during which the frequency has to stay below the sleep level before the drive stops.
P3.13.5.3 	SP1 Wake-up Level			Varies	0.0000	1018	Gives the level for the PID feedback value wake-up supervision. Uses the set process units.
P3.13.5.4 	SP1 Wake-up Mode	0	1		0	1019	The selection for the operation of P3.13.5.3. 0 = Absolute level 1 = Relative setpoint
P3.13.5.5 	SP2 Sleep Frequency	0.00	320.00	Hz	0.00	1075	See P3.13.5.1.
P3.13.5.6 	SP2 Sleep Delay	0	3000	s	0	1076	See P3.13.5.2.
P3.13.5.7 	SP2 Wake-up Level			Varies	0.0000	1077	See P3.13.5.3.
P3.13.5.8 	SP2 Wake-up Mode	0	1		0	1020	The selection for the operation of P3.13.5.7. 0 = Absolute level 1 = Relative setpoint

Table 87: Feedback supervision parameters



Index	Parameter	Min	Max	Unit	Default	ID	Description
P3.13.6.1 	Enable Feedback Supervision	0	1		0	735	0 = Disabled 1 = Enabled
P3.13.6.2 	Upper Limit	Varies	Varies	Varies	Varies	736	The supervision of the upper actual/process value.
P3.13.6.3 	Lower Limit	Varies	Varies	Varies	Varies	758	The supervision of the lower actual/process value.
P3.13.6.4	Delay	0	30000	s	0	737	If the target value is not reached in this time, a fault or alarm shows.
P3.13.6.5	Response to PID Supervision Fault	0	3		2	749	0 = No action 1 = Alarm 2 = Fault (Stop according to stop mode) 3 = Fault (Stop by coasting)

Table 88: Pressure loss compensation parameters



Index	Parameter	Min	Max	Unit	Default	ID	Description
P3.13.7.1 	Enable Setpoint 1	0	1		0	1189	Enables pressure loss compensation for the setpoint 1. 0 = Disabled 1 = Enabled
P3.13.7.2 	Setpoint 1 Max Compensation	Varies	Varies	Varies	Varies	1190	The value that is added proportionally to the frequency. Setpoint compensation = max compensation * (FreqOut-MinFreq)/(MaxFreq-MinFreq).
P3.13.7.3	Enable Setpoint 2	0	1		0	1191	See P3.13.7.1.
P3.13.7.4	Setpoint 2 Max Compensation	Varies	Varies	Varies	Varies	1192	See P3.13.7.2.

Table 89: Soft fill settings

Index	Parameter	Min	Max	Unit	Default	ID	Description
P3.13.8.1 	Enable Soft Fill	0	1		0	1094	0 = Disabled 1 = Enabled
P3.13.8.2 	Soft Fill Frequency	0.00	50.00	Hz	20.00	1055	The drive accelerates to this frequency before it starts to control. After this, the drive goes to normal PID control mode.
P3.13.8.3 	Soft Fill Level	Varies	Varies	Varies	0.0000	1095	The drive operates at the PID start frequency until the feedback reaches this value. Then the controller starts to control.
P3.13.8.4 	Soft Fill Timeout	0	30000	s	0	1096	If the target value is not reached in this time, a fault or alarm shows. 0 = No timeout NOTE! If you set the value to be 0, no fault shows.
P3.13.8.5	PID Soft Fill Timeout Response	0	3		2	738	0 = No action 1 = Alarm 2 = Fault (Stop according to stop mode) 3 = Fault (Stop by coasting)

Table 90: Input pressure supervision parameters

Index	Parameter	Min	Max	Unit	Default	ID	Description
P3.13.9.1	Enable Supervision	0	1		0	1685	0 = Disabled 1 = Enabled Enables the input pressure supervision.
P3.13.9.2	Supervision Signal	0	23		0	1686	The source of the signal of the input pressure measurement. 0 = Analogue input 1 1 = Analogue input 2 2 = Analogue input 3 3 = Analogue input 4 4 = Analogue input 5 5 = Analogue input 6 6 = ProcessDataIn1 (0-100%) 7 = ProcessDataIn2 (0-100%) 8 = ProcessDataIn3 (0-100%) 9 = ProcessDataIn4 (0-100%) 10 = ProcessDataIn5 (0-100%) 11 = ProcessDataIn6 (0-100%) 12 = ProcessDataIn7 (0-100%) 13 = ProcessDataIn8 (0-100%) 14 = Block Out.1 15 = Block Out.2 16 = Block Out.3 17 = Block Out.4 18 = Block Out.5 19 = Block Out.6 20 = Block Out.7 21 = Block Out.8 22 = Block Out.9 23 = Block Out.10
P3.13.9.3	Supervision Unit Selection	0	8	Varies	2	1687	The selection of the unit for the supervision. You can scale the supervision signal (P3.13.9.2) to process units on the panel.

Table 90: Input pressure supervision parameters

Index	Parameter	Min	Max	Unit	Default	ID	Description
P3.13.9.4	Supervision Unit Decimals	0	4		2	1688	The selection of the quantity of decimals.
P3.13.9.5	Supervision Unit Minimum Value	Varies	Varies	Varies	Varies	1689	The signal value minimum agrees to, for example, 4mA, and the signal value maximum agrees to 20mA. The values are scaled linearly between these 2.
P3.13.9.6	Supervision Unit Maximum Value	Varies	Varies	Varies	Varies	1690	
P3.13.9.7	Supervision Alarm Level	Varies	Varies	Varies	Varies	1691	An alarm shows (fault ID 1363) if the supervision signal stays below the alarm level longer than the time set in P3.13.9.9.
P3.13.9.8	Supervision Fault Level	Varies	Varies	Varies	Varies	1692	A fault shows (fault ID 1409) if the supervision signal stays below the fault level longer than the time set in P3.13.9.9.
P3.13.9.9	Supervision Fault Delay	0.00	60.00	s	5.00	1693	The delay time during which to show the supervision alarm or fault.
P3.13.9.10	PID Setpoint Reduction	0.0	100.0	%	10.0	1694	Gives the rate of the setpoint reduction of the PID controller when the alarm for the input pressure supervision is active.
V3.13.9.11	Input Pressure	Varies	Varies	Varies	Varies	1695	The monitoring value for the set signal of the input pressure supervision. Scaling value as in P3.13.9.4.

Table 91: Frost protection parameters

Index	Parameter	Min	Max	Unit	Default	ID	Description
P3.13.10.1	Frost Protection	0	1		0	1704	0 = Disabled 1 = Enabled
P3.13.10.2	Temperature Signal	0	29		6	1705	0 = Temperature Input 1 (-50..200 C) 1 = Temperature Input 2 (-50..200 C) 2 = Temperature Input 3 (-50..200 C) 3 = Temperature Input 4 (-50..200 C) 4 = Temperature Input 5 (-50..200 C) 5 = Temperature Input 6 (-50..200) 6 = Analogue input 1 7 = Analogue input 2 8 = Analogue input 3 9 = Analogue input 4 10 = Analogue input 5 11 = Analogue input 6 12 = ProcessDataIn1 (0-100%) 13 = ProcessDataIn2 (0-100%) 14 = ProcessDataIn3 (0-100%) 15 = ProcessDataIn4 (0-100%) 16 = ProcessDataIn5 (0-100%) 17 = ProcessDataIn6 (0-100%) 18 = ProcessDataIn7 (0-100%) 19 = ProcessDataIn8 (0-100%) 20 = Block Out.1 21 = Block Out.2 22 = Block Out.3 23 = Block Out.4 24 = Block Out.5 25 = Block Out.6 26 = Block Out.7 27 = Block Out.8 28 = Block Out.9 29 = Block Out.10
P3.13.10.3	Temperature Signal Minimum	-100.0	P3.13.10.4	°C/°F	-50.0 (°C)	1706	The temperature value that agrees to the minimum value of the set temperature signal.

Table 91: Frost protection parameters

Index	Parameter	Min	Max	Unit	Default	ID	Description
P3.13.10.4	Temperature Signal Maximum	P3.13.10.3	300.0	°C/°F	200.0 (°C)	1707	The temperature value that agrees to the maximum value of the set temperature signal.
P3.13.10.5	Frost Protection Temperature	P3.13.10.3	P3.13.10.4	°C/°F	5.00	1708	The temperature limit below which the Frost protection function activates.
P3.13.10.6	Frost Protection Frequency	0.0	Varies	Hz	10.0	1710	The constant frequency reference that is used when the Frost protection function activates.
V3.13.10.7	Frost Temperature Monitoring	Varies	Varies	°C/°F		1711	The monitoring value for the measured temperature signal in the Frost protection function. Scaling value: 0.1.

5.14 GROUP 3.14: EXTERNAL PID CONTROLLER

Table 92: Basic settings for the external PID controller

Index	Parameter	Min	Max	Unit	Default	ID	Description
P3.14.1.1	Enable External PID	0	1		0	1630	0 = Disabled 1 = Enabled
P3.14.1.2	Start Signal				DigIN Slot0.2	1049	FALSE = PID2 in stop mode TRUE = PID2 regulating If the PID2 controller is not enabled in the Basic menu for PID2, this parameter has no effect.
P3.14.1.3	Output in Stop	0.0	100.0	%	0.0	1100	The output value of the PID controller as a percentage of its maximum output value when it is stopped from a digital output.
P3.14.1.4	PID Gain	0.00	1000.00	%	100.00	1631	
P3.14.1.5	PID Integration Time	0.00	600.00	s	1.00	1632	
P3.14.1.6	PID Derivation Time	0.00	100.00	s	0.00	1633	
P3.14.1.7	Process Unit Selection	0	37		0	1635	
P3.14.1.8	Process Unit Min	Varies	Varies	Varies	0	1664	
P3.14.1.9	Process Unit Max	Varies	Varies	Varies	100	1665	
P3.14.1.10	Process Unit Decimals	0	4		2	1666	
P3.14.1.11	Error Inversion	0	1		0	1636	
P3.14.1.12	Dead Band	Varies	Varies	Varies	0.0	1637	
P3.14.1.13	Dead Band Delay	0.00	320.00	s	0.00	1638	

Table 93: Setpoints of the external PID controller

Index	Parameter	Min	Max	Unit	Default	ID	Description
P3.14.2.1	Keypad Setpoint 1	0.00	100.00	Varies	0.00	1640	
P3.14.2.2	Keypad Setpoint 2	0.00	100.00	Varies	0.00	1641	
P3.14.2.3	Setpoint Ramp Time	0.00	300.00	s	0.00	1642	
P3.14.2.4	Select Setpoint	Varies	Varies		DigIN Slot0.1	1048	FALSE = Setpoint 1 TRUE = Setpoint 2

Table 93: Setpoints of the external PID controller

Index	Parameter	Min	Max	Unit	Default	ID	Description
P3.14.2.5	Setpoint Source 1 Selection	0	32		1	1643	<p>0 = Not Used 1 = Keypad Setpoint 1 2 = Keypad Setpoint 2 3 = AI1 4 = AI2 5 = AI3 6 = AI4 7 = AI5 8 = AI6 9 = ProcessDataIn1 10 = ProcessDataIn2 11 = ProcessDataIn3 12 = ProcessDataIn4 13 = ProcessDataIn5 14 = ProcessDataIn6 15 = ProcessDataIn7 16 = ProcessDataIn8 17 = Temperature Input 1 18 = Temperature Input 2 19 = Temperature Input 3 20 = Temperature Input 4 21 = Temperature Input 5 22 = Temperature Input 6 23 = Block Out.1 24 = Block Out.2 25 = Block Out.3 26 = Block Out.4 27 = Block Out.5 28 = Block Out.6 29 = Block Out.7 30 = Block Out.8 31 = Block Out.9 32 = Block Out.10</p> <p>The AIs and the ProcessDataIn are handled as percentages (0.00- 100.00%) and scaled according to the setpoint minimum and maximum.</p> <p>NOTE!</p> <p>The ProcessDataIn signals use 2 decimals. If you set temperature inputs, you must set the setpoint minimum and maximum scaling parameters between -50 and 200 °C.</p>

Table 93: Setpoints of the external PID controller

Index	Parameter	Min	Max	Unit	Default	ID	Description
P3.14.2.6	Setpoint 1 minimum	-200.00	200.00	%	0.00	1644	The minimum value at the analogue signal minimum.
P3.14.2.7	Setpoint 1 maximum	-200.00	200.00	%	100.00	1645	The maximum value at the analogue signal maximum.
P3.14.2.8	Setpoint source 2 selection	0	22		0	1646	See P3.14.2.5.
P3.14.2.9	Setpoint 2 minimum	-200.00	200.00	%	0.00	1647	The minimum value at the analogue signal minimum.
P3.14.2.10	Setpoint 2 maximum	-200.00	200.00	%	100.00	1648	The maximum value at the analogue signal maximum.

Table 94: Feedback of the external PID controller

Index	Parameter	Min	Max	Unit	Default	ID	Description
P3.14.3.1	Feedback Function	1	9		1	1650	
P3.14.3.2	Feedback Function Gain	-1000.0	1000.0	%	100.0	1651	
P3.14.3.3	Feedback 1 Source Selection	0	25		1	1652	See P3.13.3.3.
P3.14.3.4	Feedback 1 Minimum	-200.00	200.00	%	0.00	1653	The minimum value at the analogue signal minimum.
P3.14.3.5	Feedback 1 Maximum	-200.00	200.00	%	100.00	1654	The maximum value at the analogue signal maximum.
P3.14.3.6	Feedback 2 Source Selection	0	25		2	1655	See P3.13.3.6.
P3.14.3.7	Feedback 2 Minimum	-200.00	200.00	%	0.00	1656	The minimum value at the analogue signal minimum.
P3.14.3.8	Feedback 2 Maximum	-200.00	200.00	%	100.00	1657	The maximum value at the analogue signal maximum.

Table 95: Process supervision of the external PID controller

Index	Parameter	Min	Max	Unit	Default	ID	Description
P3.14.4.1	Enable Supervision	0	1		0	1659	0 = Disabled 1 = Enabled
P3.14.4.2	Upper Limit	Varies	Varies	Varies	Varies	1660	
P3.14.4.3	Lower Limit	Varies	Varies	Varies	Varies	1661	
P3.14.4.4	Delay	0	30000	s	0	1662	If the target value is not reached in this time, a fault or an alarm shows.
P3.14.4.5	Response to External PID Supervision Fault	0	3		2	757	See P3.9.1.11.

5.15 GROUP 3.15: MULTIPUMP

Table 96: Multipump parameters





Index	Parameter	Min	Max	Unit	Default	ID	Description
P3.15.1	Number of Motors	1	6		1	1001	The quantity of motors (or pumps or fans) that there are in the multipump system.
P3.15.2 	Interlock Function	0	1		1	1032	Enable or disable the interlocks. You can use the interlocks to tell the system if a motor is connected. 0 = Disabled 1 = Enabled
P3.15.3 	Include FC	0	1		1	1028	Include the AC drive in the autochange and interlock system. 0 = Disabled 1 = Enabled
P3.15.4 	Autochange	0	1		1	1027	Enable or disable the rotation of the start sequence and the priority of motors. 0 = Disabled 1 = Enabled
P3.15.5	Autochange Interval	0.0	3000.0	h	48.0	1029	When this time is over, the autochange occurs if the capacity is below the level set with P3.15.6. and P3.15.7.
P3.15.6	Autochange: Frequency Limit	0.00	P3.3.1.2	Hz	25.00	1031	These parameters define the level below which the capacity must stay for the autochange to occur.
P3.15.7	Autochange: Motor Limit	1	6		1	1030	

Table 96: Multipump parameters

Index	Parameter	Min	Max	Unit	Default	ID	Description
P3.15.8	Bandwidth	0	100	%	10	1097	The percentage of the setpoint. For example, if setpoint = 5 bar, bandwidth = 10%. When the feedback value stays between 4.5 and 5.5 bar, the motor is not disconnected or removed.
P3.15.9	Bandwidth Delay	0	3600	s	10	1098	If the feedback is outside the bandwidth, this time must be over before you can add or remove pumps.
P3.15.10	Motor 1 Interlock	Varies	Varies		DigIN Slot0.1	426	FALSE = Not active TRUE = Active
P3.15.11	Motor 2 Interlock	Varies	Varies		DigIN Slot0.1	427	FALSE = Not active TRUE = Active
P3.15.12	Motor 3 Interlock	Varies	Varies		DigIN Slot0.1	428	FALSE = Not active TRUE = Active
P3.15.13	Motor 4 Interlock	Varies	Varies		DigIN Slot0.1	429	FALSE = Not active TRUE = Active
P3.15.14	Motor 5 Interlock	Varies	Varies		DigIN Slot0.1	430	FALSE = Not active TRUE = Active
P3.15.15	Motor 6 Interlock	Varies	Varies		DigIN Slot0.1	486	FALSE = Not active TRUE = Active
M3.15.16	Overpressure Supervision	See the overpressure supervision parameters below.					

Table 97: Overpressure supervision parameters

Index	Parameter	Min	Max	Unit	Default	ID	Description
P3.15.16.1 	Enable Overpressure Supervision	0	1		0	1698	0 = Disabled 1 = Enabled
P3.15.16.2	Supervision Alarm Level	P3.13.1.5	P3.13.1.6	P3.13.1.4	0.00	1699	Set the overpressure alarm level.

5.16 GROUP 3.16: MAINTENANCE COUNTERS

Table 98: Maintenance counters

Index	Parameter	Min	Max	Unit	Default	ID	Description
P3.16.1	Counter 1 Mode	0	2		0	1104	0 = Not used 1 = Hours 2 = Revolutions * 1000
P3.16.2	Counter 1 Alarm Limit	0	2147483647	h/kRev	0	1105	When a maintenance alarm shows for the counter 1. 0 = Not used
P3.16.3	Counter 1 Fault Limit	0	2147483647	h/kRev	0	1106	When a maintenance fault shows for the counter 1. 0 = Not used
B3.16.4	Counter 1 Reset	0	1		0	1107	Activate to reset counter 1.
P3.16.5	Counter 1 DI Reset	Varies	Varies		0	490	TRUE = Reset

5.17 GROUP 3.17: FIRE MODE

Table 99: Fire mode parameters





Index	Parameter	Min	Max	Unit	Default	ID	Description
P3.17.1 	Fire Mode Password	0	9999		0	1599	1002 = Enabled 1234 = Test mode
P3.17.2	Fire Mode Frequency Source	0	18		0	1617	Selection of the frequency reference source when Fire mode is active. This enables the selection of for example the AI1 or the PID controller as the reference source when you operate Fire Mode. 0 = Fire Mode frequency 1 = Preset speeds 2 = Keypad 3 = Fieldbus 4 = AI1 5 = AI2 6 = AI1 + AI2 7 = PID1 8 = Motor potentiometer 9 = Block Out.1 10 = Block Out.2 11 = Block Out.3 12 = Block Out.4 13 = Block Out.5 14 = Block Out.6 15 = Block Out.7 16 = Block Out.8 17 = Block Out.9 18 = Block Out.10
P3.17.3	Fire Mode Frequency	8.00	P3.3.1.2	Hz	50.00	1598	The frequency that is used when Fire mode is active.
P3.17.4 	Fire Mode Activation on OPEN				DigIN Slot0.2	1596	FALSE = Fire Mode active TRUE = No action
P3.17.5 	Fire Mode Activation on CLOSE				DigIN Slot0.1	1619	FALSE = No action TRUE = Fire Mode active

Table 99: Fire mode parameters

Index	Parameter	Min	Max	Unit	Default	ID	Description
P3.17.6 	Fire Mode Reverse				DigIN Slot0.1	1618	The command of the reverse rotation direction during Fire mode. This function has no effect in normal operation. DigIN Slot0.1 = Forward DigIN Slot0.2 = Reverse
V3.17.7	Fire Mode Status	0	3		0	1597	A monitoring value. See Table <i>Table 21 Items in the monitoring menu</i> . 0 = Disabled 1 = Enabled 2 = Activated (Enabled + DI Open) 3 = Test Mode The scaling value is 1.
V3.17.8	Fire Mode Counter					1679	Shows how many times Fire mode has been activated in the enabled mode. You cannot reset this counter. The scaling value is 1.

5.18 GROUP 3.18: MOTOR PREHEAT PARAMETERS

Table 100: Motor preheat parameters

Index	Parameter	Min	Max	Unit	Default	ID	Description
P3.18.1 	Motor Preheat Function	0	4		0	1225	<p>0 = Not used 1 = Always in stop state 2 = Controlled by DI 3 = Temperature limit 4 = Temperature limit (Measured motor temperature)</p> <p>NOTE! To set the selection 4, you must install an option board for temperature measurement.</p>
P3.18.2	Preheat Temperature Limit	-20	100	°C	0	1226	The motor preheat becomes active when the heatsink temperature or the measured motor temperature goes below this level, and when P3.18.1 is set to 3 or 4.
P3.18.3	Motor Preheat Current	0	31048	A	Varies	1227	The DC current for the pre-heating of the motor and the drive in stop state. Activated as in P3.18.1.
P3.18.4	Motor Preheat ON	Varies	Varies		DigIN Slot0.1	1044	<p>FALSE = No action TRUE = Preheat activated in Stop state</p> <p>Used when P3.18.1 is set to 2. When the value for P3.18.1 is 2, you can also connect time channels to this parameter.</p>

Table 100: Motor preheat parameters

Index	Parameter	Min	Max	Unit	Default	ID	Description
P3.18.5	Preheat Motor Temperature	0	6		0	1045	<p>The selection for the temperature measurement of the motor.</p> <p>0 = Not Used 1 = Temperature Input 1 2 = Temperature Input 2 3 = Temperature Input 3 4 = Temperature Input 4 5 = Temperature Input 5 6 = Temperature Input 6</p> <p>NOTE! This parameter is not available if there is no option board for temperature measurement.</p>

5.19 GROUP 3.20: MECHANICAL BRAKE

Table 101: Mechanical brake parameters

Index	Parameter	Min	Max	Unit	Default	ID	Description
P3.20.1 	Brake Control	0	2		0	1541	0 = Disabled 1 = Enabled 2 = Enabled with brake status supervision
P3.20.2 	Brake Mechanical Delay	0.00	60.00	s	0.00	353	The mechanical delay that is necessary to open the brake.
P3.20.3 	Brake Opening Frequency Limit	P3.20.4	P3.3.1.2	Hz	2.00	1535	The frequency limit for opening the mechanical brake.
P3.20.4 	Brake Closing Frequency Limit	P3.3.1.1	P3.3.1.2	Hz	2.00	1539	The frequency limit for closing the mechanical brake.
P3.20.5 	Brake Current Limit	0.0	Varies	A	0.0	1085	The mechanical brake closes immediately if the motor current is below this value.
P3.20.6	Brake Fault Delay	0.00	60.00	s	2.00	352	If the correct brake feedback signal is not received during this delay, a fault shows. This delay is only used if the value of P3.20.1 is set to 2.
P3.20.7	Response to Brake Fault	0	3		0	1316	0 = No action 1 = Alarm 2 = Fault (Stop according to stop mode) 3 = Fault (Stop by coasting)
P3.20.8 	Brake Feedback				DigIN Slot0.1	1210	Connect this input signal to the auxiliary contact of the mechanical brake. If the contact is not closed during the set time, a fault shows.

5.20 GROUP 3.21: PUMP CONTROL

Table 102: Auto-cleaning parameters

Index	Parameter	Min	Max	Unit	Default	ID	Description
P3.21.1.1 	Cleaning Function	0	1		0	1714	0 = Disabled 1 = Enabled
P3.21.1.2 	Cleaning Activation				DigIN Slot0.1	1715	The digital input signal that starts the Auto-cleaning sequence. The auto-cleaning stops if the activation signal is removed before the sequence is complete. NOTE! If the input is activated, the drive starts.
P3.21.1.3 	Cleaning Cycles	1	100		5	1716	The quantity of forward or reverse cleaning cycles.
P3.21.1.4 	Clean Forward Frequency	0.00	50.00	Hz	45.00	1717	The forward direction frequency in the Auto-cleaning cycle.
P3.21.1.5 	Clean Forward Time	0.00	320.00	s	2.00	1718	The operation time for the forward direction frequency in the Auto-cleaning cycle.
P3.21.1.6 	Clean Reverse Frequency	0.00	50.00	Hz	45.00	1719	The reverse direction frequency in the Auto-cleaning cycle.
P3.21.1.7 	Clean Reverse Time	0.00	320.00	s	0.00	1720	The operation time for reverse direction frequency in the Auto-cleaning cycle.
P3.21.1.8 	Cleaning Acceleration Time	0.1	300.0	s	0.1	1721	The motor acceleration time when the Auto-cleaning is active.

Table 102: Auto-cleaning parameters



Index	Parameter	Min	Max	Unit	Default	ID	Description
P3.21.1.9 	Cleaning Deceleration Time	0.1	300.0	s	0.1	1722	The motor deceleration time when the Auto-cleaning is active.

Table 103: Jockey pump parameters

Index	Parameter	Min	Max	Unit	Default	ID	Description
P3.21.2.1 	Jockey Function	0	2		0	1674	0 = Not used 1 = PID sleep: the jockey pump runs continuously when PID sleep is active. 2 = PID sleep (level): the jockey pump starts at predefined levels when PID sleep is active.
P3.21.2.2	Jockey Start Level	0.00	100.00	%	0.00	1675	The jockey pump starts when PID Sleep is active and the PID feedback signal goes below the level set in this parameter. NOTE! This parameter is used only if P3.21.2.1 = 2 PID sleep (level).
P3.21.2.3	Jockey Stop Level	0.00	100.00	%	0.00	1676	The jockey pump stops when PID Sleep is active and the PID feedback signal goes above the level set in this parameter, or when the PID controller wakes up from sleep mode. NOTE! This parameter is used only if P3.21.2.1 = 2 PID sleep level.

Table 104: Priming pump parameters

Index	Parameter	Min	Max	Unit	Default	ID	Description
P3.21.3.1 	Priming Function	0	1		0	1677	0 = Disabled 1 = Enabled
P3.21.3.2 	Priming Time	0.0	320.00		3.0	1678	Gives the time to start the priming pump before the main pump starts.

6 DIAGNOSTICS MENU

6.1 ACTIVE FAULTS

When there is a fault or many faults, the display shows the name of the fault and blinks. Push OK to go back to the Diagnostics menu. The submenu Active faults shows the number of faults. To see the fault-time data, make a selection of a fault and push OK.

The fault stays active until you reset it. There are 4 ways to reset a fault.

- Push the Reset button for 2 s.
- Go into the submenu Reset faults and use the parameter Reset Faults.
- Give a reset signal in the I/O terminal.
- Give a reset signal with the fieldbus.

The Active faults submenu can keep a storage of maximum 10 faults. The submenu shows the faults in the sequence in which they occurred.

6.2 RESET FAULTS

In this menu, you can reset faults. See instructions in Chapter *10.1 A fault comes into view*.



CAUTION!

Before you reset the fault, remove the external Control signal to prevent that you restart the drive.

6.3 FAULT HISTORY

You can see 40 faults in the Fault history.

To see the details of a fault, go into Fault history, find the fault and push OK.

6.4 TOTAL COUNTERS

If you read a counter value through fieldbus, see Chapter *9.19 Total and trip counters*.

Table 105: The total counter parameters in the diagnostics menu

Index	Parameter	Min	Max	Unit	Default	ID	Description
V4.4.1	Energy Counter			Varies		2291	The quantity of energy taken from the supply network. You cannot reset the counter. In the text display: the highest energy unit that the display shows is MW. If the counted energy becomes more than 999.9 MW, no unit shows on the display.
V4.4.3	Operating Time (graphical keypad)			a d hh:min		2298	The operating time of the control unit.
V4.4.4	Operating Time (text keypad)			a			The operating time of the control unit in total years.
V4.4.5	Operating Time (text keypad)			d			The operating time of the control unit in total days.
V4.4.6	Operating Time (text keypad)			hh:min: ss			The operating time of the control unit in hours, minutes and seconds.
V4.4.7	Run Time (graphical keypad)			a d hh:min		2293	The motor run time.
V4.4.8	Run Time (text keypad)			a			The motor run time in total years.
V4.4.9	Run Time (text keypad)			d			The motor run time in total days.
V4.4.10	Run Time (text keypad)			hh:min: ss			The motor run time in hours, minutes and seconds.
V4.4.11	Power On Time (graphical keypad)			a d hh:min		2294	The quantity of time that the power unit has been powered on. You cannot reset the counter.
V4.4.12	Power On Time (text keypad)			a			The power on time in total years.
V4.4.13	Power On Time (text keypad)			d			The power on time in total days.

Table 105: The total counter parameters in the diagnostics menu

Index	Parameter	Min	Max	Unit	Default	ID	Description
V4.4.14	Power On Time (text keypad)			hh:min:ss			The power on time in hours, minutes and seconds.
V4.4.15	Start Command Counter					2295	The number of times that the power unit has been started.

6.5 TRIP COUNTERS

If you read a counter value through fieldbus, see Chapter 9.19 *Total and trip counters*.

Table 106: The trip counter parameters in the diagnostics menu

Index	Parameter	Min	Max	Unit	Default	ID	Description
P4.5.1	Energy Trip Counter			Varies		2296	<p>You can reset this counter. In the text display: the highest energy unit that the display shows is MW. If the counted energy becomes more than 999.9 MW, no unit shows on the display.</p> <p>Resetting the counter</p> <ul style="list-style-type: none"> In the text display: Push the OK button for 4 s. In the graphical display: Push OK. A Reset counter page shows. Push OK again.
P4.5.3	Operating Time (graphical keypad)			a d hh:min		2299	You can reset this counter. See instructions in P4.5.1 above.
P4.5.4	Operating Time (text keypad)			a			The operating time in total years.
P4.5.5	Operating Time (text keypad)			d			The operating time in total days.
P4.5.6	Operating Time (text keypad)			hh:min:ss			The operating time in hours, minutes and seconds.

6.6 SOFTWARE INFO

Table 107: The software info parameters in the diagnostics menu

Index	Parameter	Min	Max	Unit	Default	ID	Description
V4.6.1	Software Package (graphical keypad)						The code for the software identification
V4.6.2	Software Package ID (text keypad)						
V4.6.3	Software Package Version (text keypad)						
V4.6.4	System Load	0	100	%		2300	The load on the control unit CPU
V4.6.5	Application Name (graphical keypad)						The name of the application
V4.6.6	Application ID						The code of the application
V4.6.7	Application Version						

7 I/O AND HARDWARE MENU

In this menu, there are different settings that are related to the options. The values in this menu are raw values, that is, they are not scaled by the application.

7.1 BASIC I/O

In the Basic I/O menu, you can monitor the statuses of the inputs and the outputs.

Table 108: The basic I/O parameters in the I/O and Hardware menu

Index	Parameter	Min	Max	Unit	Default	ID	Description
V5.1.1	Digital Input 1	0	1		0		Status of the digital input signal
V5.1.2	Digital Input 2	0	1		0		Status of the digital input signal
V5.1.3	Digital Input 3	0	1		0		Status of the digital input signal
V5.1.4	Digital Input 4	0	1		0		Status of the digital input signal
V5.1.5	Digital Input 5	0	1		0		Status of the digital input signal
V5.1.6	Digital Input 6	0	1		0		Status of the digital input signal
V5.1.7	Analogue Input 1 Mode	1	3		3		Shows the mode that is set for the analogue input signal. The selection is made with a DIP switch on the control board. 1 = 0...20mA 3 = 0...10V
V5.1.8	Analogue Input 1	0	100	%	0.00		Status of the analogue input signal
V5.1.9	Analogue Input 2 Mode	1	3		3		Shows the mode that is set for the analogue input signal. The selection is made with a DIP switch on the control board. 1 = 0...20mA 3 = 0...10V
V5.1.10	Analogue Input 2	0	100	%	0.00		Status of the analogue input signal

Table 108: The basic I/O parameters in the I/O and Hardware menu

Index	Parameter	Min	Max	Unit	Default	ID	Description
V5.1.11	Analogue Output 1 Mode	1	3		1		Shows the mode that is set for the analogue input signal. The selection is made with a DIP switch on the control board. 1 = 0...20mA 3 = 0...10V
V5.1.12	Analogue Output 1	0	100	%	0.00		Status of the analogue output signal
V5.1.13	Relay Output 1	0	1		0		Status of the relay output signal
V5.1.14	Relay Output 2	0	1		0		Status of the relay output signal
V5.1.15	Relay Output 3	0	1		0		Status of the relay output signal

7.2 OPTION BOARD SLOTS

The parameters in this menu are different for all the option boards. You see the parameters of the option board that you installed. If there is no option board in the slots C, D or E, you do not see parameters. See more about the location of the slots in Chapter 9.7.1 *Programming of digital and analogue inputs*.

When you remove an option board, the fault code 39 and the fault name *Device removed* show on the display. See Chapter 10.3 *Fault codes*.

Table 109: Option board related parameters

Menu	Function	Description
Slot C	Settings	The settings that are related to the option board
	Monitoring	Monitor the data that is related to the option board
Slot D	Settings	The settings that are related to the option board
	Monitoring	Monitor the data that is related to the option board
Slot E	Settings	The settings that are related to the option board
	Monitoring	Monitor the data that is related to the option board

7.3 REAL TIME CLOCK

Table 110: The real time clock parameters in the I/O and Hardware menu

Index	Parameter	Min	Max	Unit	Default	ID	Description
V5.5.1	Battery State	1	3		2	2205	Status of the battery. 1 = Not installed 2 = Installed 3 = Replace the battery
P5.5.2	Time			hh:mm:ss		2201	The current time of the day
P5.5.3	Date			dd.mm.		2202	The current date
P5.5.4	Year			yyyy		2203	The current year
P5.5.5	Daylight Saving	1	4		1	2204	The daylight saving rule 1 = Off 2 = EU: starts on the last Sunday in March, ends on the last Sunday in October 3 = US: starts on the 2nd Sunday in March, ends on the 1st Sunday in November 4 = Russia (permanent)

7.4 POWER UNIT SETTINGS

In this menu, you can change the settings of the fan, the brake chopper and the sine filter.

The fan operates in the optimised or the always on mode. In the optimised mode, the internal logic of the drive receives data about the temperature and controls the fan speed. After the drive goes in the Ready state, the fan stops in 5 minutes. In the always on mode, the fan operates in full speed, and does not stop.

The Sine filter keeps the overmodulation depth in limits and does not let the thermal management functions decrease the switching frequency.

Table 111: Power unit settings

Index	Parameter	Min	Max	Unit	Default	ID	Description
P5.6.1.1	Fan Control Mode	0	1		1	2377	0 = Always on 1 = Optimised
P5.6.2.1	Brake Chopper Mode	0	3		0		0 = Disabled 1 = Enabled (Run) 2 = Enabled (Run & Stop) 3 = Enabled (Run, no testing)
P5.6.4.1	Sine Filter	0	1		0		0 = Disabled 1 = Enabled

7.5 KEYPAD

Table 112: The keypad parameters in the I/O and Hardware menu

Index	Parameter	Min	Max	Unit	Default	ID	Description
P5.7.1	Timeout Time	0	60	min	0		The time after which the display goes back to the page that is set with parameter P5.7.2. 0 = Not used
P5.7.2	Default Page	0	4		0		The page that the display shows when the drive is powered up, or when the time that is set with P5.7.1 is expired. If the value is set to 0, the display shows the last page that it showed. 0 = None 1 = A menu index 2 = Main menu 3 = Control page 4 = Multimonitor
P5.7.3	Menu Index						Set a page to be the menu index. (The selection 1 in P5.7.2.)
P5.7.4	Contrast *	30	70	%	50		Set the contrast of the display.
P5.7.5	Backlight Time	0	60	min	5		Set the time after which the backlight of the display turns off. If the value is set to 0, the backlight is always on.

* Only available with the graphical keypad.

7.6 FIELDBUS

In the I/O and Hardware menu, there are the parameters that are related to fieldbus boards. You can find the instructions on how to use these parameters in the related fieldbus manual.

Submenu level 1	Submenu level 2	Submenu level 3	Submenu level 4
RS-485	Common settings	Protocol	Modbus RTU
			N2
			Bacnet MSTP
RS-485	Modbus RTU	Parameters	Slave address
			Baud rate
			Parity type
			Stop bits
			Communication timeout
			Operate mode
		Monitoring	Fieldbus protocol status
			Communication status
			Illegal functions
			Illegal data addresses
			Illegal data values
			Slave device busy
			Memory parity error
			Slave device failure
			Last fault response
			Control Word
			Status Word

Submenu level 1	Submenu level 2	Submenu level 3	Submenu level 4
RS-485	N2	Parameters	Slave address
			Communication timeout
		Monitoring	Fieldbus protocol status
			Communication status
			Invalid data
			Invalid commands
			Command not accepted
			Control word
			Status word
			RS-485
Autobauding			
MAC address			
Instance number			
Communication timeout			
Monitoring	Fieldbus protocol status		
	Communication status		
	Actual instance number		
	Fault code		
	Control word		
Status word			
Ethernet	Common settings	IP address mode	
		Fixed IP	IP address
			Subnet mask
			Default gateway
		IP address	
		Subnet mask	
		Default gateway	
		MAC address	

Submenu level 1	Submenu level 2	Submenu level 3	Submenu level 4
Ethernet	Modbus TCP	Parameters	Connection limit
			Unit Identifier number
			Communication timeout
		Monitoring	Fieldbus protocol status
			Communication status
			Illegal functions
			Illegal data addresses
			Illegal data values
			Slave device busy
			Memory parity error
			Slave device failure
			Last fault response
			Control word
			Status word
Ethernet	Bacnet IP	Parameters	Instance number
			Communication timeout
			Protocol in use
			BBMD IP
			BBMD Port
			Time to live
		Monitoring	Fieldbus protocol status
			Communication status
			Actual instance number
			Control word
			Status word

Submenu level 1	Submenu level 2	Submenu level 3	Submenu level 4
Ethernet	Ethernet/ IP	Parameters	Protocol in use
			Output Instance
			Input Instance
			Communication Timeout
		Monitoring	Reset Counters
			Open Request
			Open Format Reject
			Open Resource Rejects
			Open Other Rejects
			Close Requests
			Close Format Rejects
			Close Other Rejects
			Connection Timeouts
			Communication Status
			Control Word
			Status Word
Fieldbus Protocol Status			
Ethernet	Profinet IO	Parameters	Protocol in use
			Communication timeout
		Monitoring	FB Protocol Status
			Comm. Status
			Setpoint Telegram
			Actual Value Telegram
			Number of Process Data
			Control Word
			Status Word
			Connection Timeouts
			Parameter accesses

8 USER SETTINGS, FAVOURITES AND USER LEVEL MENUS

8.1 USER SETTINGS

Table 113: General settings in the user settings menu

Index	Parameter	Min	Max	Unit	Default	ID	Description
P6.1	Language selection	Varies	Varies		Varies	802	The selection is different in all the language packages
M6.5	Parameter backup						See Table 8.1.1 <i>Parameter backup.</i>
M6.6	Parameter compare						
P6.7	Drive name						Give a name to the drive if you think that it is necessary.

8.1.1 PARAMETER BACKUP

Table 114: The parameter backup parameters in the user settings menu

Index	Parameter	Min	Max	Unit	Default	ID	Description
P6.5.1	Restore Factory Defaults					831	Restores the default parameter values and starts the Startup wizard.
P6.5.2	Save to Keypad *	0	1		0		Saves the parameter values to the control panel, for example to copy them to another drive. 0 = No 1 = Yes
P6.5.3	Restore from Keypad *						Loads the parameter values from the control panel to the drive.
B6.5.4	Save to Set 1						Keeps a customised parameter set (that is, all the parameters included in the application).
B6.5.5	Restore from Set 1						Loads the customised parameter set to the drive.
B6.5.6	Save to Set 2						Keeps another customised parameter set (that is, all the parameters included in the application).
B6.5.7	Restore from Set 2						Loads the customised parameter set 2 to the drive.

* Only available with the graphical display.

8.2 FAVOURITES

**NOTE!**

This menu is not available in the text display.

If you use the same items frequently, you can add them into Favourites. You can collect a set of parameters or monitoring signals from all the keypad menus. It is not necessary to find

them in the menu structure one by one. As an alternative, add them into the Favourites folder where it is easy to find them.

ADDING AN ITEM TO THE FAVOURITES

- 1 Find the item that you want to add to Favourites. Push the OK button.

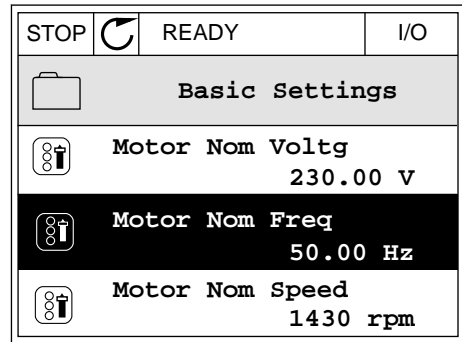

- 2 Make a selection of *Add to favourites* and push the OK button.

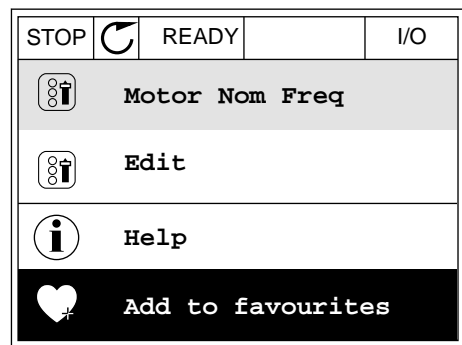

- 3 The steps are now completed. To continue, read the instructions on the display.

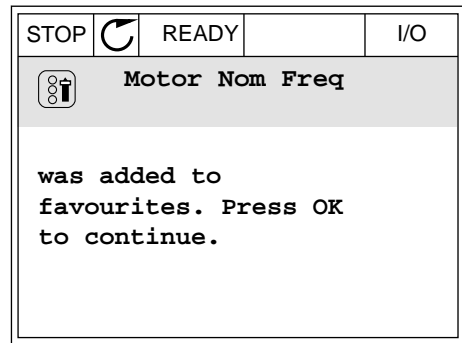

REMOVING AN ITEM FROM THE FAVOURITES

- 1 Go to the Favourites.

- 2 Find the item that you want to remove. Push the OK button.

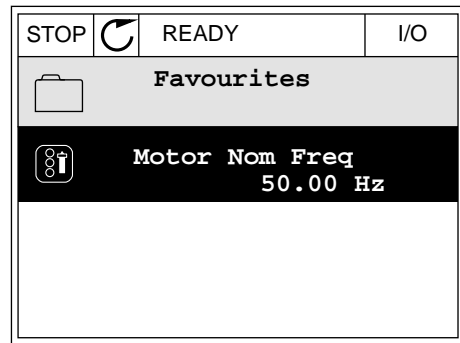

- 3 Make a selection of *Rem from favourites*.

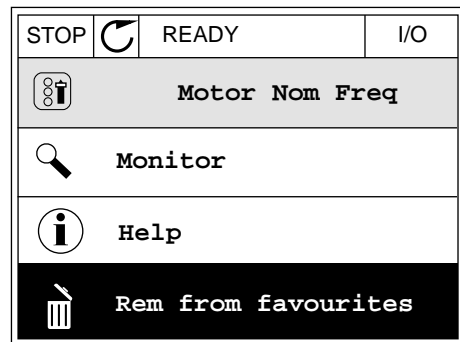

- 4 To remove the item, push the OK button again.

8.3 USER LEVELS

Use the User level parameters to keep the personnel who are not approved from making changes in the parameters. You can also prevent accidental changes in the parameters.

When you make a selection of a user level, the user cannot see all the parameters on the display of the control panel.

Table 115: The user level parameters

Index	Parameter	Min	Max	Unit	Default	ID	Description
P8.1	User Level	1	3		1	1194	1 = Normal. All the menus are visible in the main menu. 2 = Monitoring. Only the monitoring and user level menus are visible in the main menu. 3 = Favourites. Only the favourites and user level menus are visible in the main menu.
P8.2	Access Code	0	99999		0	2362	If you set the value to be to other than 0 before you go to <i>Monitoring</i> from, for example, <i>Normal</i> , you have to give the access code when you go back to <i>Normal</i> . This prevents personnel who are not approved from making changes in the parameters on the control panel.



CAUTION!

Do not lose the access code. If the access code is lost, contact your nearest service center or partner.

CHANGING THE ACCESS CODE OF THE USER LEVELS

- 1 Go to the User levels.
- 2 Go to the item Access code and push the arrow button Right.

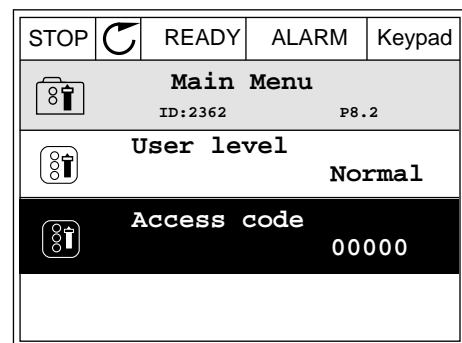

- To change the digits of the access code, use all the arrow buttons.

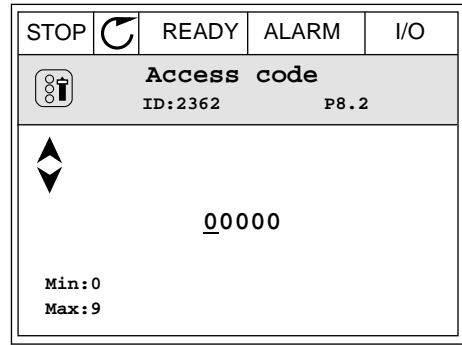

- Accept the change with the OK button.

9 PARAMETER DESCRIPTIONS

In this chapter, you can find data on the most special parameters of the application. For most parameters of the Vacon 100 application, a basic description is sufficient. You can find these basic descriptions in the parameter tables of Chapter 5 *Parameters menu*. If other data is necessary, your distributor will help you.

P1.2 APPLICATION (ID212)

In P1.2 you can make a selection of an application that is best for your process. The applications include preset application configurations, that is, sets of predefined parameters. The selection of the application makes the commissioning of the drive easy and reduces the manual work with the parameters.

These configurations are loaded to the drive when the value of parameter P1.2 Application changes. You can change the value of this parameter when you make the start up or the commissioning of the drive.

If you use the control panel to change this parameter, an application wizard starts and helps you to set the basic parameters related to the application. The wizard does not start, if you use the PC tool to change this parameter. You can find data about the application wizards in Chapter 2 *Wizards*.

These applications are available:

- 0 = Standard
- 1 = Local/Remote
- 2 = Multi-step speed
- 3 = PID control
- 4 = Multi-purpose
- 5 = Motor potentiometer



NOTE!

When you change the application, the contents of the Quick Setup menu change.

9.1 MOTOR SETTINGS

P3.1.1.2 MOTOR NOMINAL FREQUENCY (ID 111)

When this parameter changes, parameters P3.1.4.2 Field Weakening Point Frequency and P3.1.4.3 Voltage at Field Weakening Point start automatically. The 2 parameters have different values for each motor type. See the tables in *P3.1.2.2 Motor Type (ID 650)*.

P3.1.2.1 CONTROL MODE (ID 600)

Selection number	Selection name	Description
0	Frequency control (open loop)	The frequency reference of the drive is set to the output frequency without slip compensation. The actual speed of the motor is specified by the motor load.
1	Speed control (sensorless control)	The frequency reference of the drive is set to the motor speed reference. The motor load does not have an effect on the motor speed. There is slip compensation.
2	Torque control (open loop)	The motor torque is controlled. The motor produces torque in the set speed limits to achieve torque reference. P3.3.2.7 (Torque Control Frequency Limit) controls the motor speed limit.

P3.1.2.2 MOTOR TYPE (ID 650)

In this parameter, you can set the type of motor in your process.

Selection number	Selection name	Description
0	Induction motor (IM)	Make this selection if you use an induction motor.
1	Permanent Magnet Motor (PM)	Make this selection if you use a permanent magnet motor.

When this parameter changes, parameters P3.1.4.2 and P3.1.4.3 start automatically. The 2 parameters have different values for each motor type.

Parameter	Induction motor (IM)	Permanent magnet motor (PM)
P3.1.4.2 (Field Weakening Point Frequency)	Motor nominal frequency	Internally calculated
P3.1.4.3 (Voltage at Field Weakening Point)	100.0%	Internally calculated

P3.1.2.4 IDENTIFICATION (ID 631)

The identification run calculates or measures the motor parameters that are necessary for a good control of the motor and speed.

The identification run helps you to adjust the motor-specific and the drive-specific parameters. It is a tool for the commissioning and the servicing of the drive. The goal is to find the parameter values that are optimal for the operation of the drive.

**NOTE!**

Before you do the identification run, you have to set the motor nameplate parameters.

Selection number	Selection name	Description
0	No action	No identification requested.
1	Identification at standstill	The drive operates without speed when you do the identification run for the motor parameters. The motor receives current and voltage, but the frequency is zero. The U/f ratio and start magnetisation parameters are identified.
2	Identification with motor rotating	The drive operates with speed when you do the identification run for the motor parameters. The U/f ratio, the magnetisation current and start magnetisation parameters are identified. To get accurate results, do this identification run with no load on the motor shaft.

To activate the Identification function, set the parameter P3.1.2.4 and give a start command. You have to give the start command in 20 s. If there is no start command in that time, the identification run does not start. The parameter P3.1.2.4 is reset to the default value and an identification alarm shows.

To stop the identification run before it is completed, give a stop command. This resets the parameter to the default value. If the identification run is not completed, an identification alarm shows.



NOTE!

To start the drive after the identification, a new start command is necessary.

P3.1.2.6 MOTOR SWITCH (ID 653)

You can use this parameter if there is a switch between the drive and the motor in your system. The operation of a motor switch makes sure that an electrical circuit is de-energized from the motor during the servicing.

When you enable this parameter, the motor switch opens and disconnects the motor from the drive. This does not cause the drive to trip. It is not necessary to change the run command or the reference signal to the drive.

When the servicing is done, disable the parameter P3.1.2.6 to connect the motor again. The drive operates the motor speed to agree with the reference speed of the process commands. If the motor rotates when you connect it, the drive finds the speed of the motor with the Flying start function. Then the drive increases the speed to agree with the process commands.

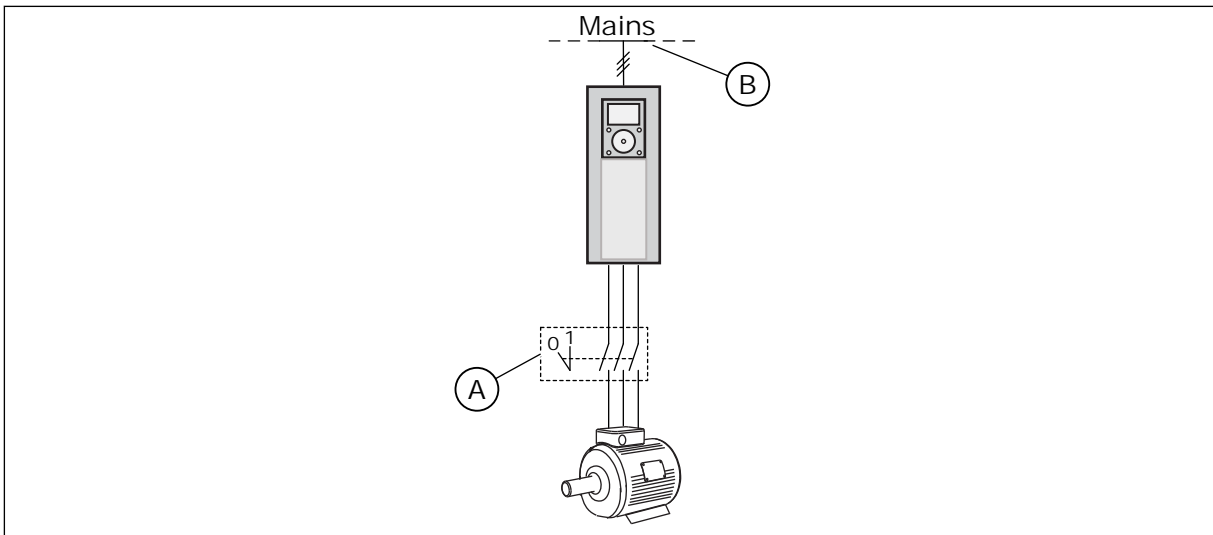

Fig. 20: The motor switch between the drive and the motor

- A. The motor switch
- B. Mains

P3.1.2.7 LOAD DROOPING (ID 620)

The Load drooping function enables a speed drop. This parameter sets the drooping in percentage of the nominal torque of the motor.

You can use this function when a balanced load is necessary for mechanically connected motors. This is called static drooping. You can also use the function when a dynamic drooping is necessary because the load changes. In static drooping, the Load Drooping Time is set to 0, so that the drooping cannot decay. In dynamic drooping, the Load Drooping Time is set. The load is momentarily drooped with energy from the system inertia. This decreases the current torque spikes when the load changes suddenly.

If the motor has a nominal frequency of 50 Hz, the motor is loaded with the nominal load (100% of the torque), and Load Drooping is set to 10%, the output frequency is let to decrease 5 Hz from the frequency reference.

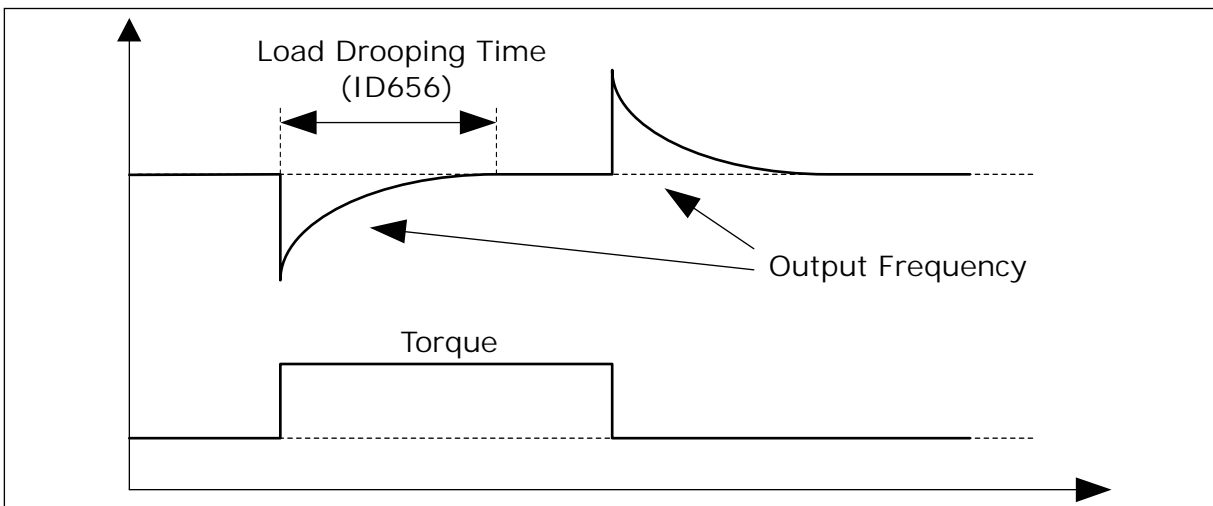

Fig. 21: The Load drooping function

P3.1.2.10 OVERVOLTAGE CONTROL (ID 607)

See the description in P3.1.2.11 Undervoltage Control.

P3.1.2.11 UNDERVOLTAGE CONTROL (ID 608)

When you enable P3.1.2.10 or P3.1.2.11, the controllers start to monitor the changes in the supply voltage. The controllers change the output frequency if it becomes too high or too low.

To stop the operation of the undervoltage and the overvoltage controllers, disable these 2 parameters. This is useful if the supply voltage changes more than -15% to +10%, and if the application does not tolerate the operation of the controllers.

P3.1.2.13 STATOR VOLTAGE ADJUST (ID 659)



NOTE!

The identification run sets a value for this parameter automatically. We recommend that you make the identification run, if it is possible. You can make the identification run with the parameter P3.1.2.4.

It is possible to use this parameter only when the parameter P3.1.2.2 Motor Type has the value *PM motor*. If you set *induction motor* as the motor type, the value is automatically set to 100%, and you cannot change the value.

When you change the value of P3.1.2.2 (Motor type) to *PM Motor*, the parameters P3.1.4.2 (Field Weakening Point Frequency) and P3.1.4.3 (Voltage at Field Weakening Point) will increase automatically to be equal with output voltage of the drive. The set U/f ratio does not change. This is done to prevent the operation of the PM motor in the field weakening area. The nominal voltage of the PM motor is much lower than the full output voltage of the drive.

The nominal voltage of the PM motor agrees to the back-EMF voltage of the motor at nominal frequency. But in a different motor manufacturer, it can be equal to, for example, the stator voltage at nominal load.

Stator Voltage Adjust helps you to adjust the U/f curve of the drive near the back-EMF curve. It is not necessary to change the values of many U/f curve parameters.

The parameter P3.1.2.13 gives the output voltage of the drive in percentage of the nominal voltage of the motor at the nominal frequency of the motor. Adjust the U/f curve of the drive above the back-EMF curve of the motor. The motor current increases the more the U/f curve is different from the back-EMF curve.

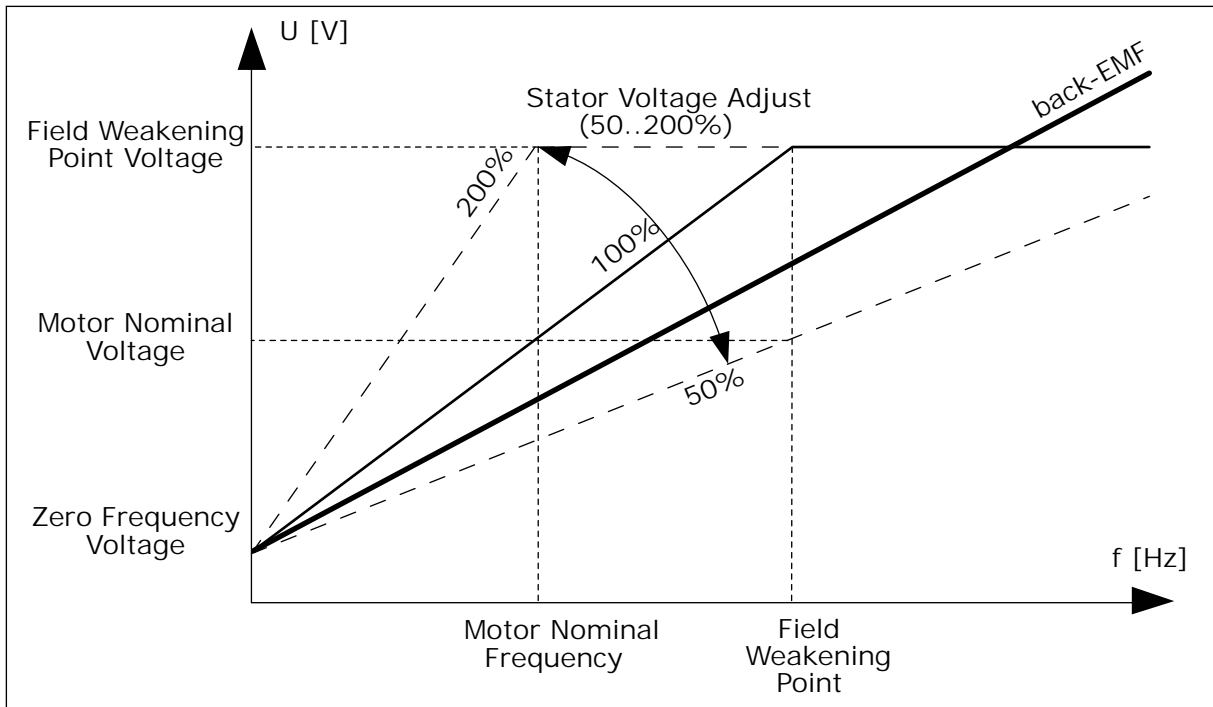

Fig. 22: The stator voltage adjustment

P3.1.2.14 OVERMODULATION (ID 1515)

Overmodulation maximises the output voltage of the drive, but increases the motor current harmonics.

P3.1.3.1 MOTOR CURRENT LIMIT (ID 107)

This parameter tells the maximum motor current from the AC drive. The range of values for the parameter is different for each frame size of the drive.

When the current limit is active, the drive output frequency is decreases.



NOTE!

The Motor Current Limit is not an overcurrent trip limit.

P3.1.4.1 U/F RATIO (ID 108)

Selection number	Selection name	Description
0	Linear	The voltage of the motor changes linearly as a function of the output frequency. The voltage changes from the value of P3.1.4.6 (Zero Frequency Voltage) to the value of P3.1.4.3 (Voltage at Field Weakening Point) at a frequency set in P3.1.4.2 (Field Weakening Point Frequency). Use this default setting if a different setting is not necessary.
1	Squared	The voltage of the motor changes from the value of P3.1.4.6 (Zero Frequency Voltage) to the value of P3.1.4.2 (Field Weakening Point Frequency) at a squared curve. The motor operates undermagnetised below the field weakening point and produces less torque. You can use the squared U/f ratio in applications where the torque demand is in relation to the square of the speed, for example in centrifugal fans and pumps.
2	Programmable	It is possible to program the U/f curve with 3 different points: the zero frequency voltage (P1), the midpoint voltage/frequency (P2), and the field weakening point (P3). You can use the programmable U/f curve at low frequencies if it is necessary to have more torque. You can find the optimal settings automatically with an identification run (P3.1.2.4).

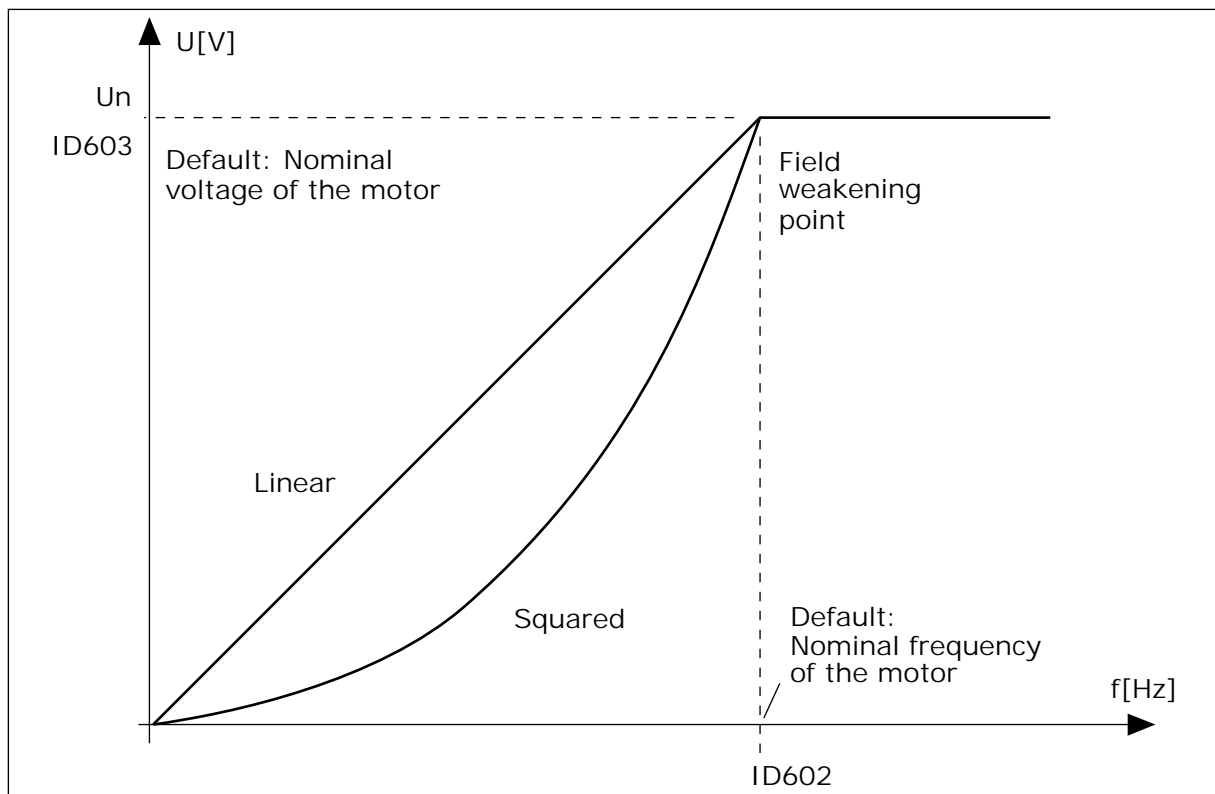

Fig. 23: Linear and squared change of the motor voltage

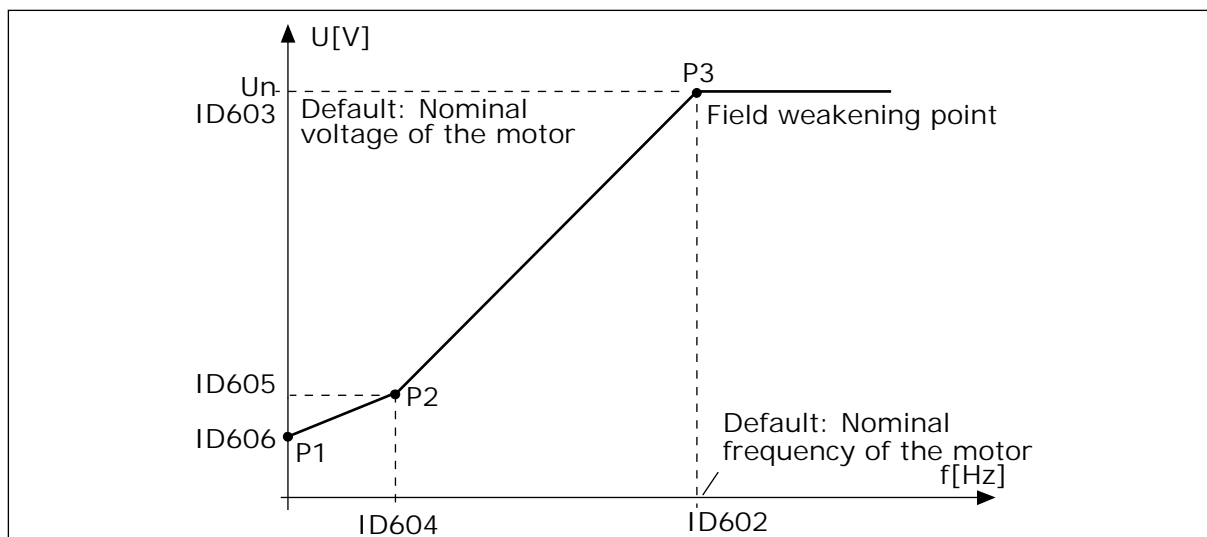

Fig. 24: The programmable U/f curve

When the parameter Motor Type has the value *PM motor (Permanent Magnet Motor)*, this parameter is automatically set to the value *Linear*.

When the parameter Motor Type has the value *Induction Motor*, and when this parameter is changed, these parameters are set to their default values.

- P3.1.4.2 Field Weakening Point Frequency
- P3.1.4.3 Voltage at Field Weakening Point
- P3.1.4.4 U/f Midpoint Frequency
- P3.1.4.5 U/f Midpoint Voltage
- P3.1.4.6 Zero Frequency Voltage

P3.1.4.3 VOLTAGE AT FIELD WEAKENING POINT (ID 603)

Above the frequency at the field weakening point, the output voltage stays at the set maximum value. Below the frequency at the field weakening point, the U/f curve parameters control the output voltage. See the U/f parameters P3.1.4.1, P3.1.4.4 and P3.1.4.5.

When you set the parameters P3.1.1.1 (Motor nominal voltage) and P3.1.1.2 (Motor nominal frequency), the parameters P3.1.4.2 and P3.1.4.3 automatically receive related values. To have different values for P3.1.4.2 and P3.1.4.3, change these parameters only after you set the parameters P3.1.1.1 and P3.1.1.2.

P3.1.4.7 FLYING START OPTIONS (ID 1590)

The parameter Flying Start Options has a checkbox selection of values.

The bits can receive these values.

- Search the shaft frequency only from the same direction as the frequency reference
- Disable the AC scanning
- Use the frequency reference for an initial guess
- Disable the DC pulses

The bit B0 controls the search direction. When you set the bit to 0, the shaft frequency is searched in 2 directions, the positive and the negative. When you set the bit to 1, the shaft frequency is searched only in the frequency reference direction. This prevents the shaft movements for the other direction.

The bit B1 controls the AC scanning that premagnetises the motor. In the AC scanning, the system sweeps the frequency from the maximum towards zero frequency. The AC scanning stops when an adaptation to the shaft frequency occurs. To disable the AC scanning, set the bit B1 to 1. If the value of Motor Type is permanent magnet motor, the AC scanning is disabled automatically.

With the bit B5 you can disable the DC pulses. The primary function of the DC pulses is to premagnetise the motor and examine the rotation of the motor. If the DC pulses and the AC scanning are enabled, the slip frequency tells which procedure is applied. If the slip frequency is less than 2 Hz, or the motor type is PM motor, the DC pulses are disabled automatically.

P3.1.4.9 AUTOMATIC TORQUE BOOST (ID 109)

Use this parameter with a process that has a high starting torque because of friction.

The voltage to the motor changes in relation to the necessary torque. This makes the motor give more torque at the start and when the motor operates at low frequencies.

The torque boost has an effect with a linear U/f curve. You can get the best result when you have done the identification run and activated the programmable U/f curve.

9.1.1 I/F START FUNCTION

When you have a PM motor, use the I/f Start function to start the motor with constant current control. You can receive the best effect with a high power motor. With a high power motor, the resistance is low and it is not easy to change the U/f curve.

The I/f Start function can also give a sufficient torque for the motor at startup.

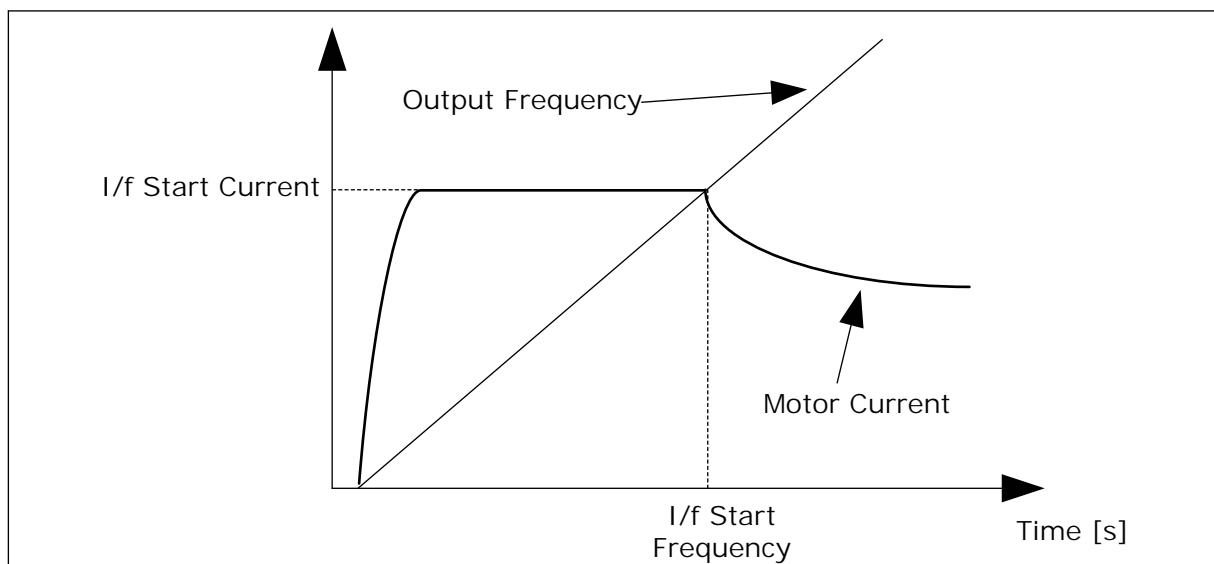

Fig. 25: The I/f start parameters

P3.1.4.12.1 I/F START (ID 534)

When you activate the I/f Start function, the drive starts to operate in the current control mode. A constant current is led to the motor until the output frequency increases above the level that is set in P3.1.4.12.2. When the output frequency increases above I/f Start Frequency level, the operation mode changes back to the normal U/f control mode.

P3.1.4.12.2 I/F START FREQUENCY (ID 535)

When the output frequency of the drive is below the limit of this parameter, I/f Start function activates. When the output frequency is more than the limit, the drive operation mode changes back to the normal U/f control mode.

P3.1.4.12.3 I/F START CURRENT (ID 536)

With this parameter, you can set the current that is used when the I/f Start function is enabled.

9.1.2 TORQUE STABILATOR FUNCTION

P3.1.4.13.1 TORQUE STABILATOR GAIN (ID 1412)

P3.1.4.13.2 TORQUE STABILATOR GAIN AT FIELD WEAKENING POINT (ID 1414)

The torque stabiliser stabilises the possible oscillations in the estimated torque.

Two gains are used. TorqStabGainFWP is a constant gain at all the output frequencies. TorqStabGain changes linearly between the zero frequency and the field weakening point frequency. The full gain is at 0 Hz and the gain is zero at the field weakening point. The figure shows the gains as a function of output frequency.

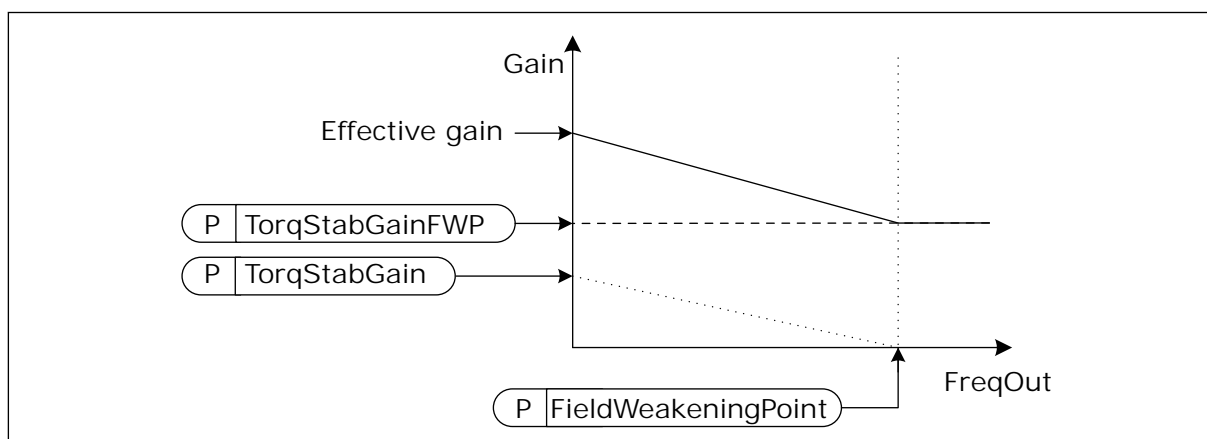

Fig. 26: The torque stabilator gain

P3.1.4.13.3 TORQUE STABILATOR DAMPING TIME CONSTANT (ID 1413)

The damping time constant of the torque stabiliser.

P3.1.4.13.4 TORQUE STABILATOR DAMPING TIME CONSTANT FOR PMM (ID 1735)

The damping time constant of the torque stabiliser for PM motors (Permanent Magnet motors).

9.2 START/STOP SETUP

You must give the start and stop commands differently in each control place.

REMOTE CONTROL PLACE (I/O A)

Use the parameters P3.5.1.1 (Control signal 1 A), P3.5.1.2 (Control signal 2 A) and P3.5.1.3 (Control signal 3 A) to make a selection of digital inputs. These digital inputs control the start, stop and reverse commands. Then make a selection of a logic for these inputs with P3.2.6 I/O A Logic.

REMOTE CONTROL PLACE (I/O B)

Use the parameters P3.5.1.4 (Control signal 1 B), P3.5.1.5 (Control signal 2 B) and P3.5.1.6 (Control signal 3 B) to make a selection of digital inputs. These digital inputs control the start, stop and reverse commands. Then make a selection of a logic for these inputs with P3.2.7 I/O B Logic.

LOCAL CONTROL PLACE (KEYPAD)

The start and stop commands come from the keypad buttons. The direction of the rotation is set with parameter P3.3.1.9 Keypad direction.

REMOTE CONTROL PLACE (FIELDBUS)

Start, stop and reverse commands come from the fieldbus.

P3.2.5 STOP FUNCTION (ID 506)

Table 116:

Selection number	Selection name	Description
0	Coasting	The motor stops on its inertia. When the stop command is given, the control by the drive stops and the current from the drive goes to 0.
1	Ramp	After the stop command, the speed of the motor is decreased to zero speed according to the deceleration parameters.

P3.2.6 I/O A START/STOP LOGIC (ID 300)

It is possible to control the start and stop of the drive with the digital signals in this parameter.

The selections that include the word edge help you to prevent an accidental start.

An accidental start can occur, for example, in these conditions

- When you connect the power.
- When the power is connected again after a power cut.
- After you reset a fault.
- After Run Enable stops the drive.
- When you change the control place to I/O control.

Before you can start the motor, you must open the Start/Stop contact.

In all the examples of the next pages, the stop mode is coasting. CS = Control signal.

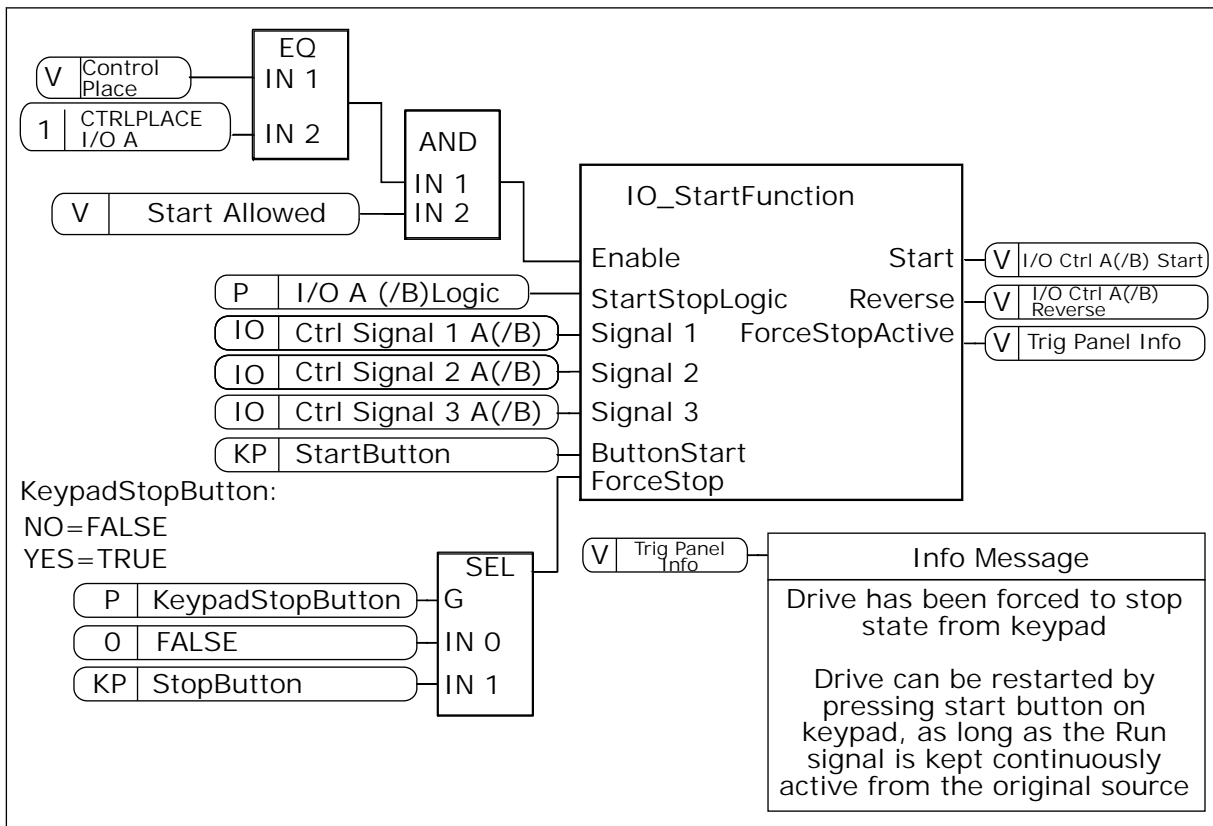

Fig. 27: The block diagram of the I/O A Start/stop logic

Selection number	Selection name	Description
0	CS1 = Forward CS2 = Backward	The functions activate when the contacts are closed.

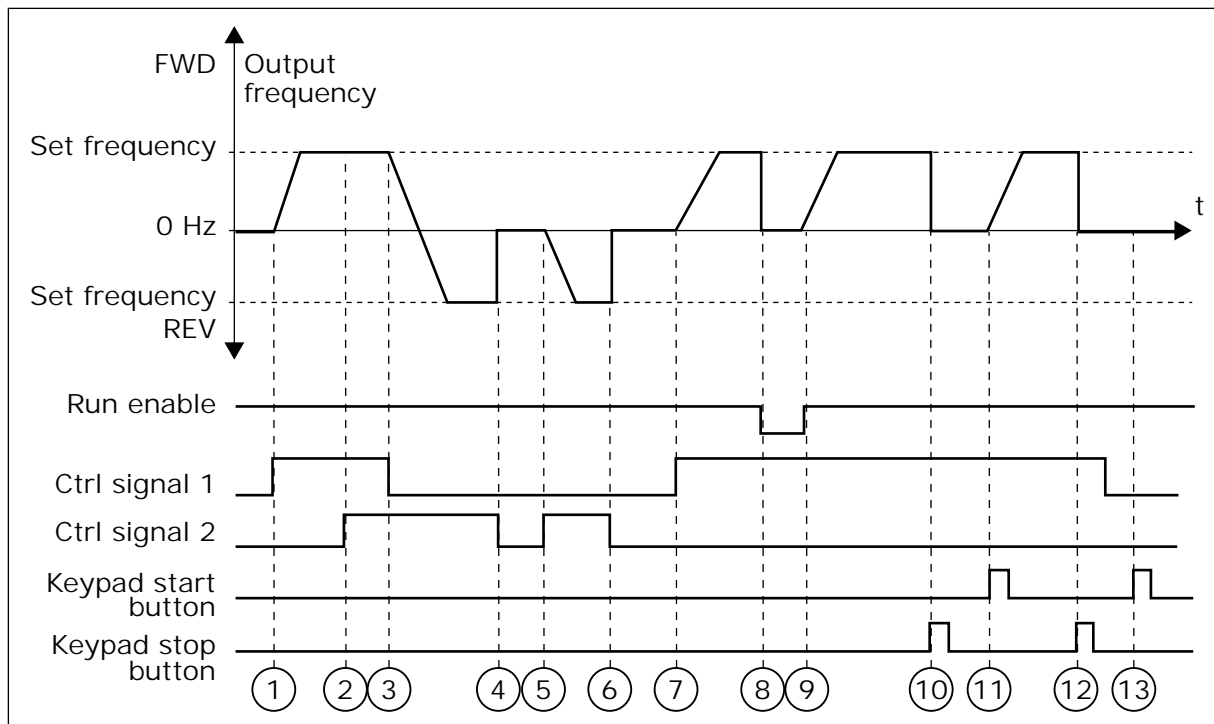

Fig. 28: I/O A Start/stop logic = 0

1. Control signal (CS) 1 activates and causes the output frequency to increase. The motor operates forward.
2. CS2 activates, but it does not have an effect on the output frequency, because the direction that is set first has the highest priority.
3. CS1 becomes inactive and causes the direction to start to change (FWD to REV), because CS2 is still active.
4. CS2 becomes inactive and the frequency that is fed to the motor goes to 0.
5. CS2 activates again and causes the motor to accelerate (REV) to the set frequency.
6. CS2 becomes inactive and the frequency fed to the motor drops to 0.
7. CS1 activates and the motor accelerates (FWD) to the set frequency
8. The Run enable signal is set to FALSE, which causes the frequency to go to 0. Configure the Run enable signal with parameter P3.5.1.15.
9. The Run enable signal is set to TRUE, which causes the frequency to increase to the set frequency, because CS1 is still active.
10. The STOP button on the keypad is pushed, and the frequency that is fed to the motor goes to 0. (This signal only works if the value of P3.2.3 Keypad Stop Button is Yes.)
11. The drive starts because the START button on the keypad was pushed.
12. The STOP button on the keypad is pushed again to stop the drive.
13. The attempt to start the drive with the START button is not successful, because CS1 is inactive.

Selection number	Selection name	Description
1	CS1 = Forward (edge) CS2 = Inverted stop CS3 = Backward (edge)	For a 3-wire control (pulse control)

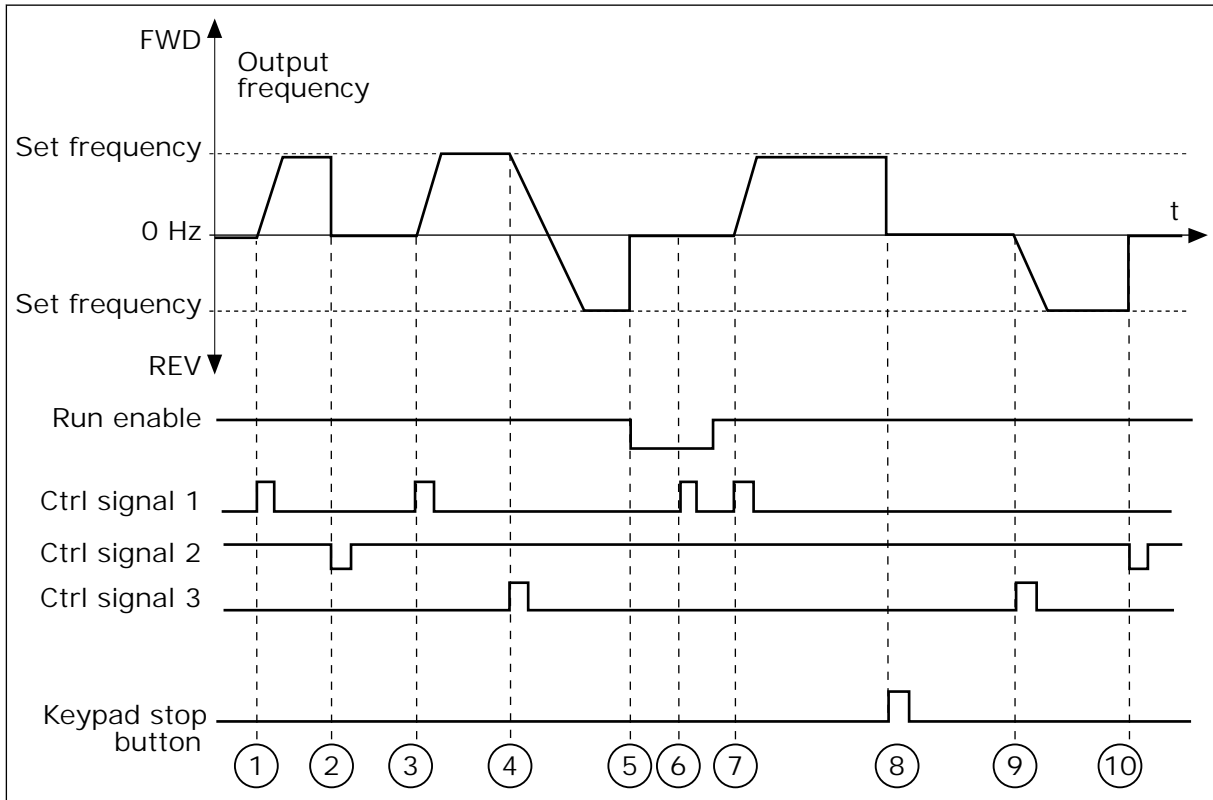

Fig. 29: I/O A Start/stop logic = 1

- Control signal (CS) 1 activates and causes the output frequency to increase. The motor operates forward.
- CS2 becomes inactive and causes the frequency to go to 0.
- CS1 activates and causes the output frequency to increase again. The motor operates forward.
- CS3 activates and causes the direction to start to change (FWD to REV).
- The Run enable signal is set to FALSE, which causes the frequency to go to 0. Configure the Run enable signal with parameter 3.5.1.15.
- The start attempt with CS1 is not successful, because the Run enable signal is still FALSE.
- CS1 activates and the motor accelerates (FWD) to the set frequency, because the Run enable signal was set to TRUE.
- The STOP button on the keypad is pushed, and the frequency that is fed to the motor goes to 0. (This signal only works if the value of P3.2.3 Keypad Stop Button is Yes.)
- CS3 activates and causes the motor to start and to operate in the reverse direction.
- CS2 becomes inactive and causes the frequency to go to 0.

Selection number	Selection name	Description
2	CS1 = Forward (edge) CS2 = Backward (edge)	Use this function to prevent an accidental start. Before you can start the motor again, you must open the start/stop contact.

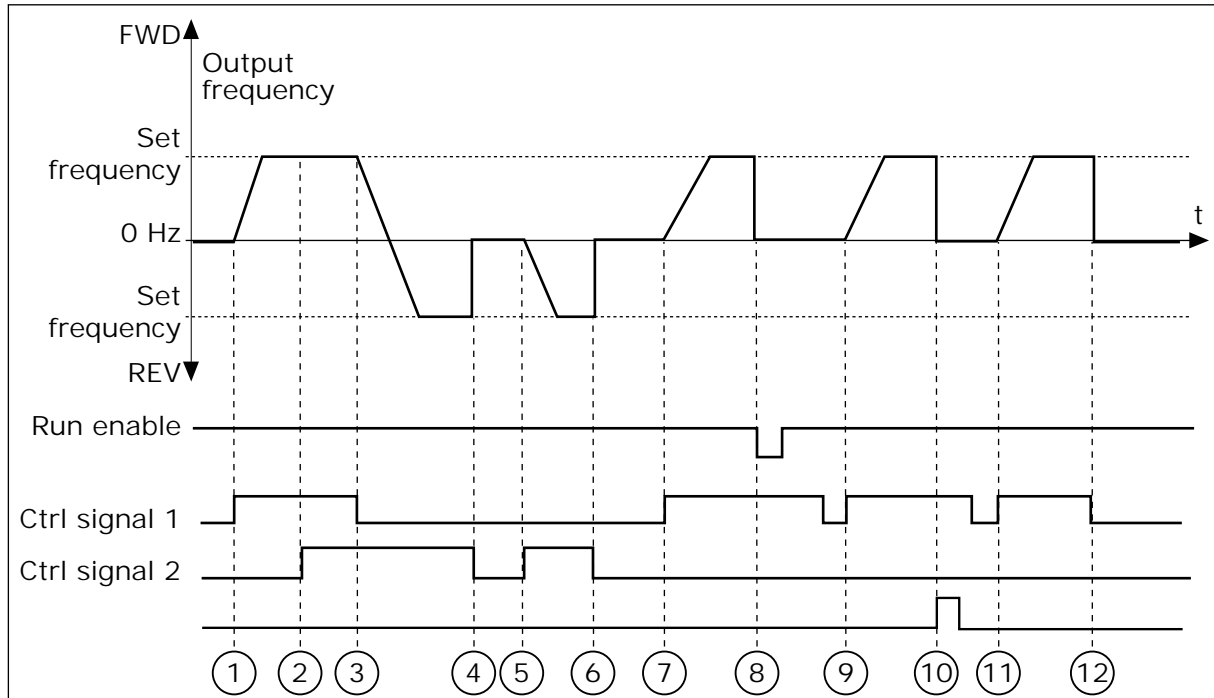

Fig. 30: I/O A Start/stop logic = 2

- Control signal (CS) 1 activates and causes the output frequency to increase. The motor operates forward.
- CS2 activates, but it does not have an effect on the output frequency, because the direction that is set first has the highest priority.
- CS1 becomes inactive and causes the direction to start to change (FWD to REV), because CS2 is still active.
- CS2 becomes inactive and the frequency that is fed to the motor goes to 0.
- CS2 activates again and causes the motor to accelerate (REV) to the set frequency.
- CS2 becomes inactive and the frequency that is fed to the motor goes to 0.
- CS1 activates and the motor accelerates (FWD) to the set frequency.
- The Run enable signal is set to FALSE, which causes the frequency to go to 0. Configure the Run enable signal with parameter P3.5.1.15.
- The Run enable signal is set to TRUE, which does not have an effect, because a rising edge is necessary for the start, even if CS1 is active.
- The STOP button on the keypad is pushed and the frequency that is fed to the motor goes to 0. (This signal only works if the value of P3.2.3 Keypad Stop Button is Yes.)
- CS1 is opened and closed again, which causes the motor to start.
- CS1 becomes inactive and the frequency that is fed to the motor goes to 0.

Selection number	Selection name	Description
3	CS1 = Start CS2 = Reverse	

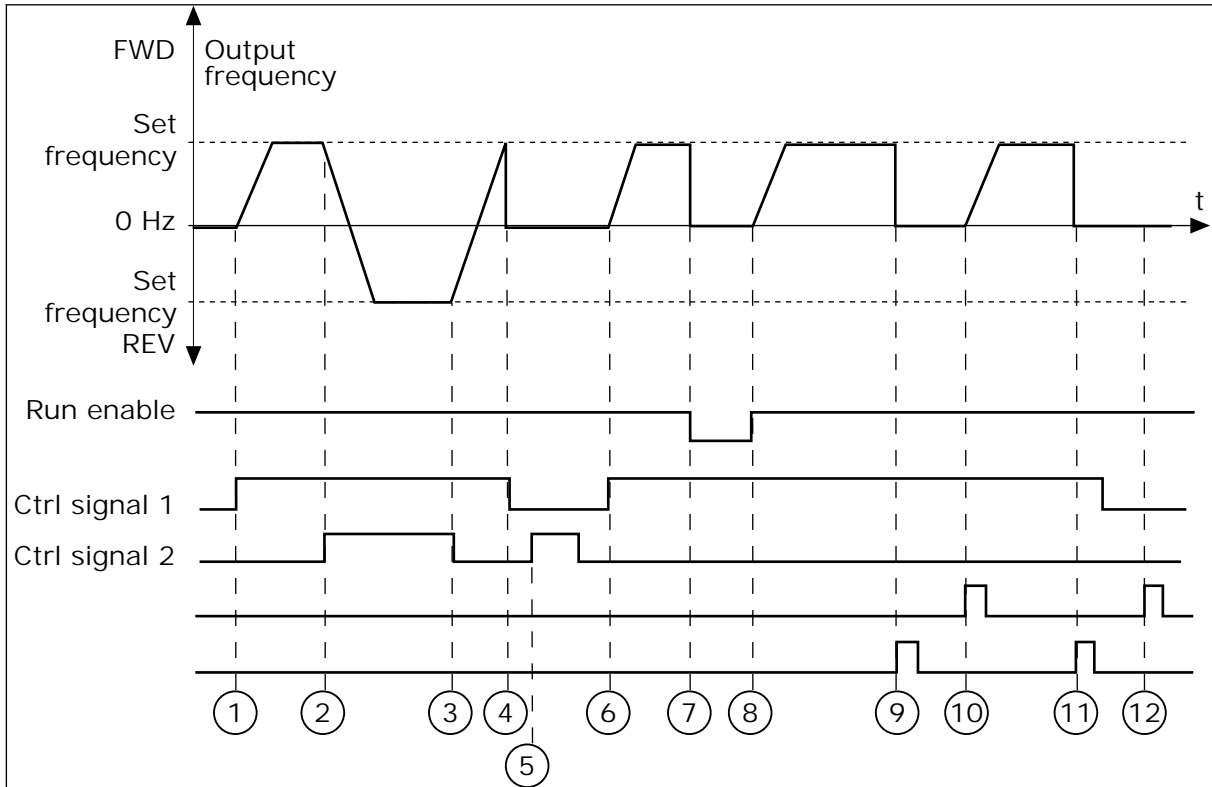

Fig. 31: I/O A Start/stop logic = 3

- Control signal (CS) 1 activates and causes the output frequency to increase. The motor operates forward.
- CS2 activates and causes the direction to start to change (FWD to REV).
- CS2 becomes inactive, which causes the direction to start to change (REV to FWD), because CS1 is still active.
- CS1 becomes inactive and the frequency goes to 0.
- CS2 activates, but the motor does not start because CS1 is inactive.
- CS1 activates and causes the output frequency to increase again. The motor operates forward because CS2 is inactive.
- The Run enable signal is set to FALSE, which causes the frequency to go to 0. Configure the Run enable signal with parameter P3.5.1.15.
- The Run enable signal is set to TRUE, which causes the frequency to increase to the set frequency, because CS1 is still active.
- The STOP button on the keypad is pushed and the frequency that is fed to the motor goes to 0. (This signal only works if the value of P3.2.3 Keypad Stop Button is Yes.)
- The drive starts because the START button on the keypad was pushed.
- The drive is stopped again with the STOP button on the keypad.

- The attempt to start the drive with the START button is not successful, because CS1 is inactive.

Selection number	Selection name	Description
4	CS1 = Start (edge) CS2 = Reverse	Use this function to prevent an accidental start. Before you can start the motor again, you must open the start/stop contact.

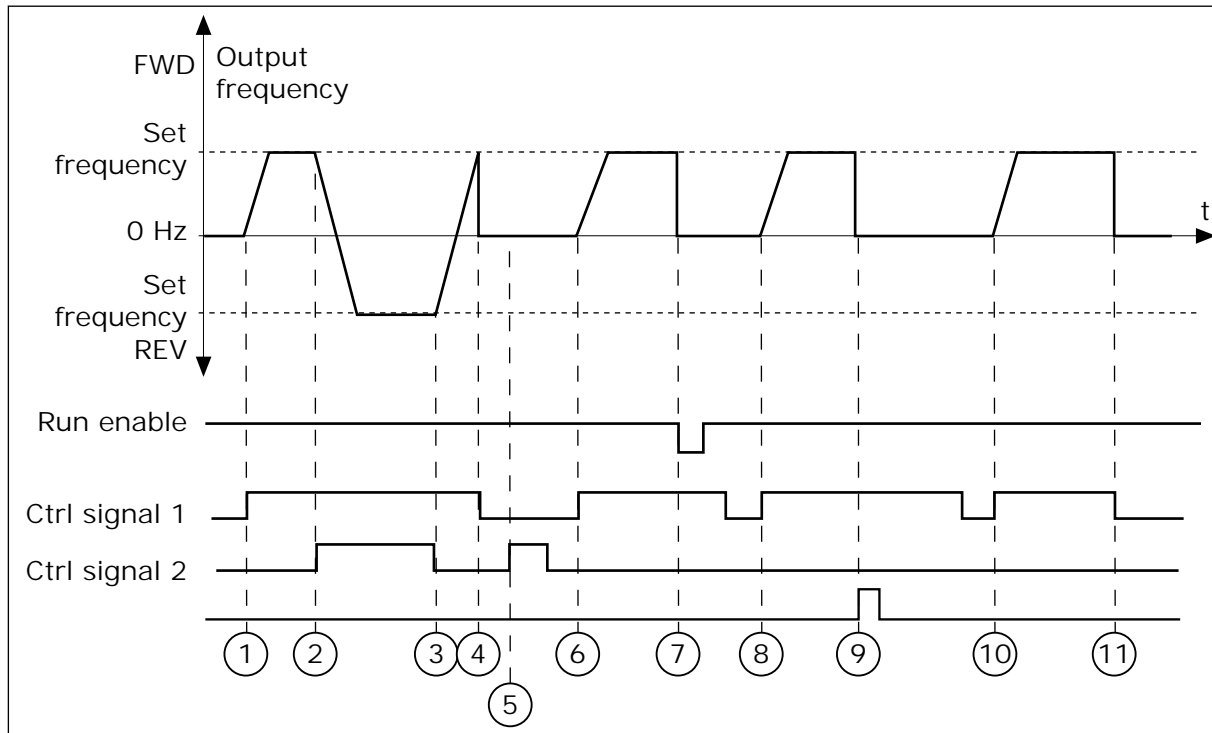

Fig. 32: I/O A Start/stop logic = 4

- Control signal (CS) 1 activates and causes the output frequency to increase. The motor operates forward because CS2 is inactive.
- CS2 activates, which causes the direction to start to change (FWD to REV).
- CS2 becomes inactive, which causes the direction to start to change (REV to FWD), because CS1 is still active.
- CS1 becomes inactive and the frequency goes to 0.
- CS2 activates, but the motor does not start because CS1 is inactive.
- CS1 activates and causes the output frequency to increase again. The motor operates forward, because CS2 is inactive.
- The Run enable signal is set to FALSE, which causes the frequency to go to 0. Configure the Run enable signal with parameter P3.5.1.15.
- Before the drive can start, you must open and close CS1 again.
- The STOP button on the keypad is pushed and the frequency that is fed to the motor goes to 0. (This signal only works if the value of P3.2.3 Keypad Stop Button is Yes.)
- Before the drive can start, you must open and close CS1 again.

11. CS1 becomes inactive and the frequency goes to 0.

9.3 REFERENCES

9.3.1 FREQUENCY REFERENCE

It is possible to program the source of the frequency reference in all the control places, except the PC tool. If you use your PC, it always takes the frequency reference from the PC tool.

REMOTE CONTROL PLACE (I/O A)

To set the source of the frequency reference for I/O A, use the parameter P3.3.1.5 .

REMOTE CONTROL PLACE (I/O B)

To set the source of the frequency reference for I/O B, use the parameter P3.3.1.6.

LOCAL CONTROL PLACE (KEYPAD)

If you use the default value *keypad* for the parameter P3.3.1.7, the reference that you set for P3.3.1.8 Keypad Reference applies.

REMOTE CONTROL PLACE (FIELDBUS)

If you keep the default value *fieldbus* for the parameter P3.3.1.10, the frequency reference comes from fieldbus.

9.3.2 TORQUE REFERENCE

When the parameter P3.1.2.1 (Control Mode) is set to *Torque control open loop*, the motor torque is controlled. The motor speed changes to agree with the actual load on the motor shaft. P3.3.2.7 (Torque Control Frequency Limit) controls the motor speed limit.

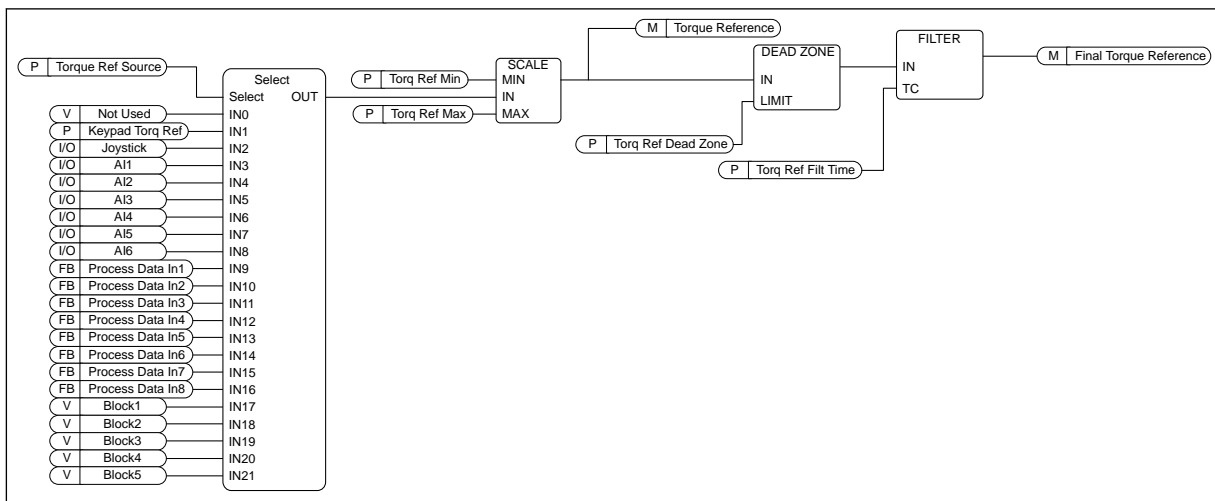

Fig. 33: The torque reference chain diagram

P3.3.2.2 TORQUE MINIMUM REFERENCE (ID 643)

Parameter P3.3.2.2 defines the minimum torque reference of the positive and negative values.

P3.3.2.3 TORQUE MAXIMUM REFERENCE (ID 642)

Parameter P3.3.2.3 defines the maximum torque reference of the positive and negative values.

These parameters define the scaling of selected torque reference signal. For instance, the analogue input signal is scaled between the Torque Reference Minimum and the Torque Reference Maximum.

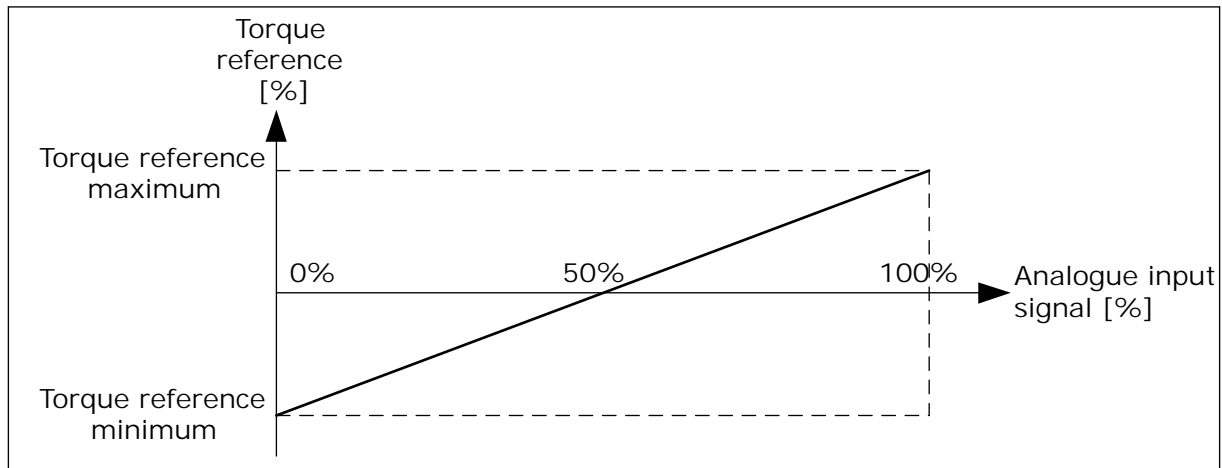

Fig. 34: Scaling of the torque reference signal

P3.3.2.7 TORQUE CONTROL FREQUENCY LIMIT (ID 1278)

In the torque control mode, the drive output frequency is always limited between MinFreqReference and MaxFreqReference (P3.3.1.1 and P3.3.1.2).

You can also make the selection of 2 other modes with this parameter.

Selection 0 = *Pos/Neg Freq Limits*, that is, the positive/negative frequency limits.

The frequency is limited between Positive Frequency Reference Limit (P3.3.1.3) and Negative Frequency Reference Limit (P3.3.1.4) (if these parameters are set lower than the value of P3.3.1.2 Maximum Frequency).

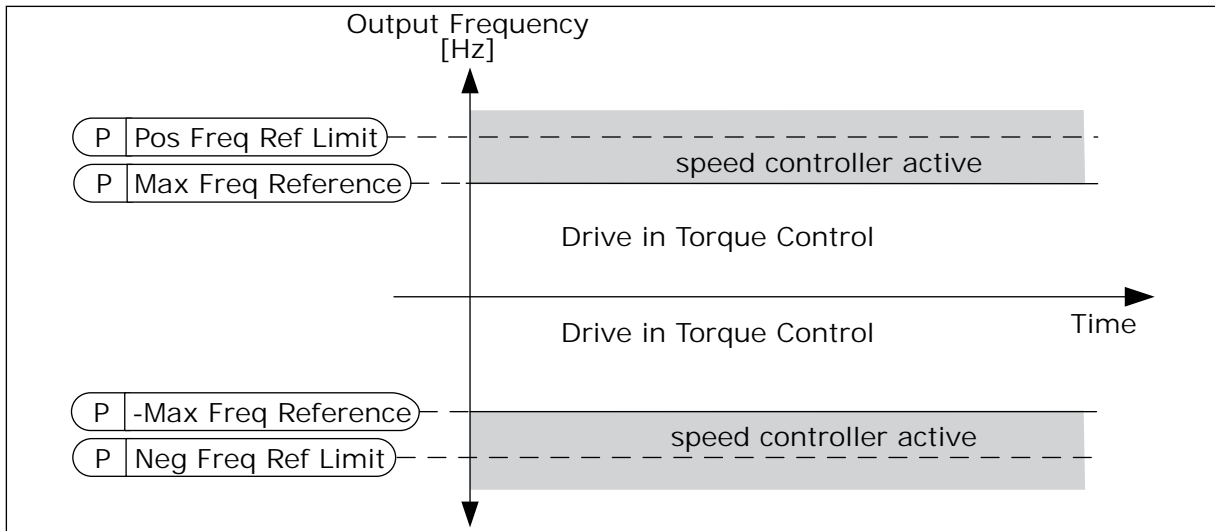

Fig. 35: Torque control frequency limit, selection 0

Selection 1 = Freq Reference, that is, the frequency reference for both directions.

The frequency is limited by the actual frequency reference (after the ramp generator) for both directions. That is, the output frequency increases within the set ramp time until the actual torque is equal to the referenced torque.

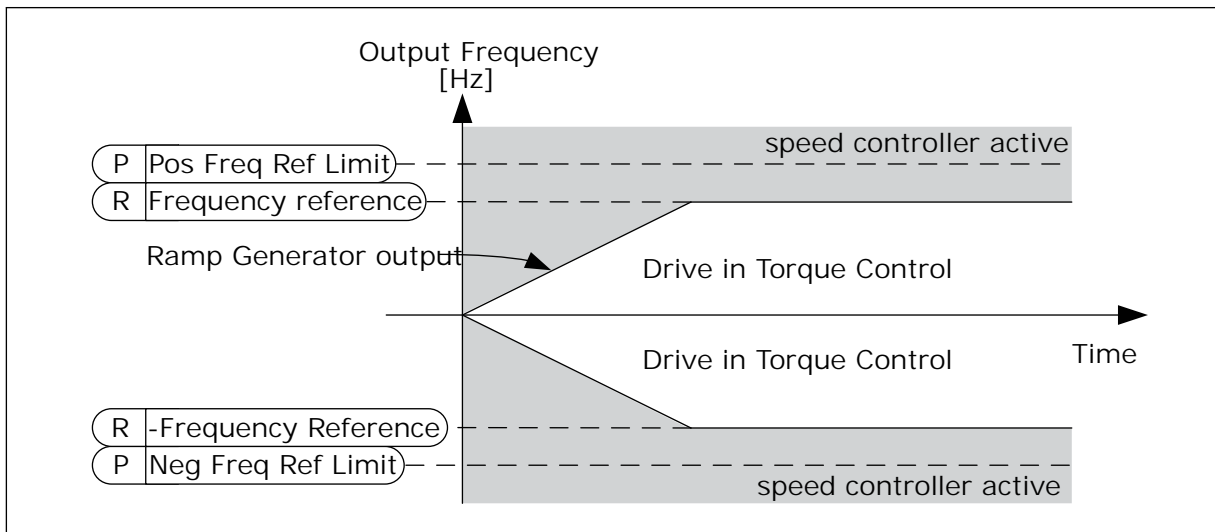

Fig. 36: Torque control frequency limit, selection 1

9.3.3 PRESET FREQUENCIES

You can use the Preset frequencies function in processes where more than 1 fixed frequency reference is necessary. There are 8 preset frequency references available. You can make the selection of a preset frequency reference with the digital input signals P3.3.3.10, P3.3.3.11, and P3.3.3.12.

P3.3.3.1 PRESET FREQUENCY MODE (ID 182)

With this parameter, you can set the logic which one of the preset frequencies is selected into use. There is a selection of 2 different logics.

Selection number	Selection name	Description
0	Binary coded	The mix of the inputs is binary coded. The different sets of active digital inputs determine the preset frequency. See more data in the Table <i>Table 117 The selection of preset frequencies when P3.3.3.1 = Binary coded.</i>
1	Number (of inputs used)	The number of active inputs tells which preset frequency is used: 1, 2 or 3.

P3.3.3.2 PRESET FREQUENCY 0 (ID 180)

P3.3.3.3 PRESET FREQUENCY 1 (ID 105)

P3.3.3.4 PRESET FREQUENCY 2 (ID 106)

P3.3.3.5 PRESET FREQUENCY 3 (ID 126)

P3.3.3.6 PRESET FREQUENCY 4 (ID 127)

P3.3.3.7 PRESET FREQUENCY 5 (ID 128)

P3.3.3.8 PRESET FREQUENCY 6 (ID 129)

P3.3.3.9 PRESET FREQUENCY 7 (ID 130)

VALUE 0 SELECTED FOR PARAMETER P3.3.3.1:

To set Preset Frequency 0 as reference, set the value 0 *Preset Frequency 0* for P3.3.1.5 (I/O Control Reference A Selection).

To make a selection of a preset frequency between 1 and 7, give digital inputs to P3.3.3.10 (Preset Frequency Selection 0), P3.3.3.11 (Preset Frequency Selection 1), and/or P3.3.3.12 (Preset Frequency Selection 2). The different sets of active digital inputs determine the preset frequency. You can find more data in the table below. The values of the preset frequencies stay automatically between the minimum and maximum frequencies (P3.3.1.1 and P3.3.1.2).

Necessary step	Activated frequency
Make a selection of the value 0 for parameter P3.3.1.5.	Preset frequency 0

Table 117: The selection of preset frequencies when P3.3.3.1 = Binary coded

Activated digital input signal			Activated frequency reference
Preset Freq Sel2 (P3.3.3.12)	Preset Freq Sel1 (P3.3.3.11)	Preset Freq Sel0 (P3.3.3.10)	
			Preset frequency 0 Only if Preset Freq 0 is set as frequency reference source with P3.3.3.1.5, P3.3.1.6, P3.3.1.7 or P3.3.1.10.
		*	Preset frequency 1
	*		Preset frequency 2
	*	*	Preset frequency 3
*			Preset frequency 4
*		*	Preset frequency 5
*	*		Preset frequency 6
*	*	*	Preset frequency 7

* = the input is activated.

VALUE 1 SELECTED FOR PARAMETER P3.3.3.1:

You can use the Preset Frequencies 1 to 3 with different sets of active digital inputs. The number of active inputs tells which one is used.

Table 118: The selection of preset frequencies when P3.3.3.1 = Number of inputs

Activated digital input signal			Activated frequency reference
Preset Freq Sel2 (P3.3.3.12)	Preset Freq Sel1 (P3.3.3.11)	Preset Freq Sel0 (P3.3.3.10)	
			Preset frequency 0 Only if Preset Freq 0 is set as frequency reference source with P3.3.3.1.5, P3.3.1.6, P3.3.1.7 or P3.3.1.10.
		*	Preset frequency 1
	*		Preset frequency 1
*			Preset frequency 1
	*	*	Preset frequency 2
*		*	Preset frequency 2
*	*		Preset frequency 2
*	*	*	Preset frequency 3

* = the input is activated.

P3.3.3.10 PRESET FREQUENCY SELECTION 0 (ID 419)

P3.3.3.11 PRESET FREQUENCY SELECTION 1 (ID 420)

P3.3.3.12 PRESET FREQUENCY SELECTION 2 (ID 421)

To apply Preset frequencies 1 to 7, connect a digital input to these functions with the instructions in Chapter 9.7.1 *Programming of digital and analogue inputs*. See more data in Table 117 *The selection of preset frequencies when P3.3.3.1 = Binary coded* and also in Tables Table 41 *Preset frequency parameters* and Table 50 *Digital input settings*.

9.3.4 MOTOR POTENTIOMETER PARAMETERS

The frequency reference of the Motor Potentiometer is available in all the control places. You can change the motor potentiometer reference only when the drive is in the run state.



NOTE!

If you set the output frequency slower than the Motor Potentiometer Ramp Time, the normal acceleration and deceleration times give limits to it.

P3.3.4.1 MOTOR POTENTIOMETER UP (ID 418)

With a motor potentiometer, you can increase and decrease the output frequency. When you connect a digital input to parameter Motor Potentiometer UP, and have the digital input signal active, the output frequency rises.

P3.3.4.2 MOTOR POTENTIOMETER DOWN (ID 417)

With a motor potentiometer, you can increase and decrease the output frequency. When you connect a digital input to parameter Motor Potentiometer DOWN, and have the digital input signal active, the output frequency falls.

3 different parameters have an effect on how the output frequency rises or falls when Motor Potentiometer UP or DOWN is active. These parameters are Motor Potentiometer Ramp Time (P3.3.4.3), Ramp Acceleration Time (P3.4.1.2), and Ramp Deceleration Time (P3.4.1.3).

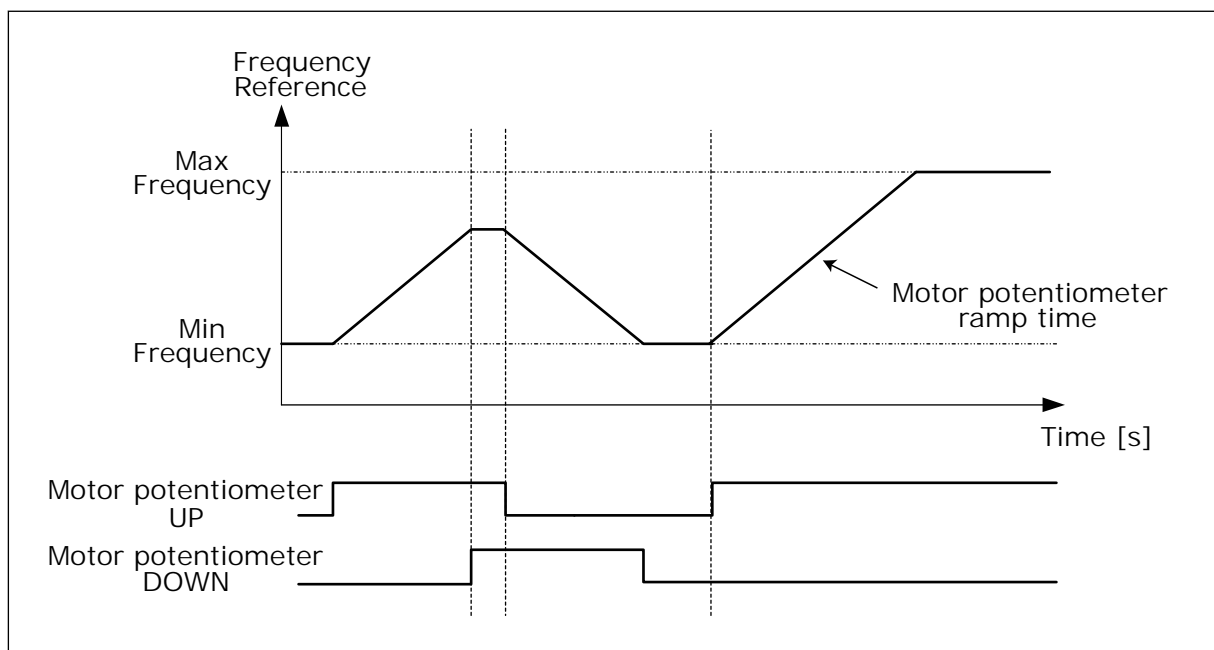

Fig. 37: The motor potentiometer parameters

P3.3.4.4 MOTOR POTENTIOMETER RESET (ID 367)

This parameter defines the logic for the resetting of the frequency reference of the motor potentiometer.

There are 3 selections in the reset function: no reset, reset when the drive stops, or reset when the drive is powered down.

Selection number	Selection name	Description
0	No reset	The last motor potentiometer frequency reference is kept through the stop state and kept in memory if a powerdown occurs.
1	Stop state	The motor potentiometer frequency reference is set to 0 when the drive goes to the stop state, or when the drive is powered down.
2	Powered down	The motor potentiometer frequency reference is set to 0 only when a powerdown occurs.

9.4 JOYSTICK PARAMETERS

Use the joystick parameters when you control the frequency reference or the torque reference of the motor with a joystick. To control the motor with a joystick, connect the joystick signal to an analogue input and set the joystick parameters.



CAUTION!

We recommend strongly that you use the Joystick function with analogue inputs of the range -10V...+10V. In this case, if a wire breaks, the reference does not go to the maximum value.

P3.3.5.1 JOYSTICK SIGNAL SELECTION (ID 451)

With this parameter, you can set the analogue input signal that controls the Joystick function.

Use the Joystick function to control the frequency reference of the drive or the torque reference.

P3.3.5.2 JOYSTICK DEAD ZONE (ID 384)

To ignore the small values of the reference around 0, set this value to be bigger than 0. When the analogue input signal is $0 \pm$ the value of this parameter, the joystick reference is set to 0.

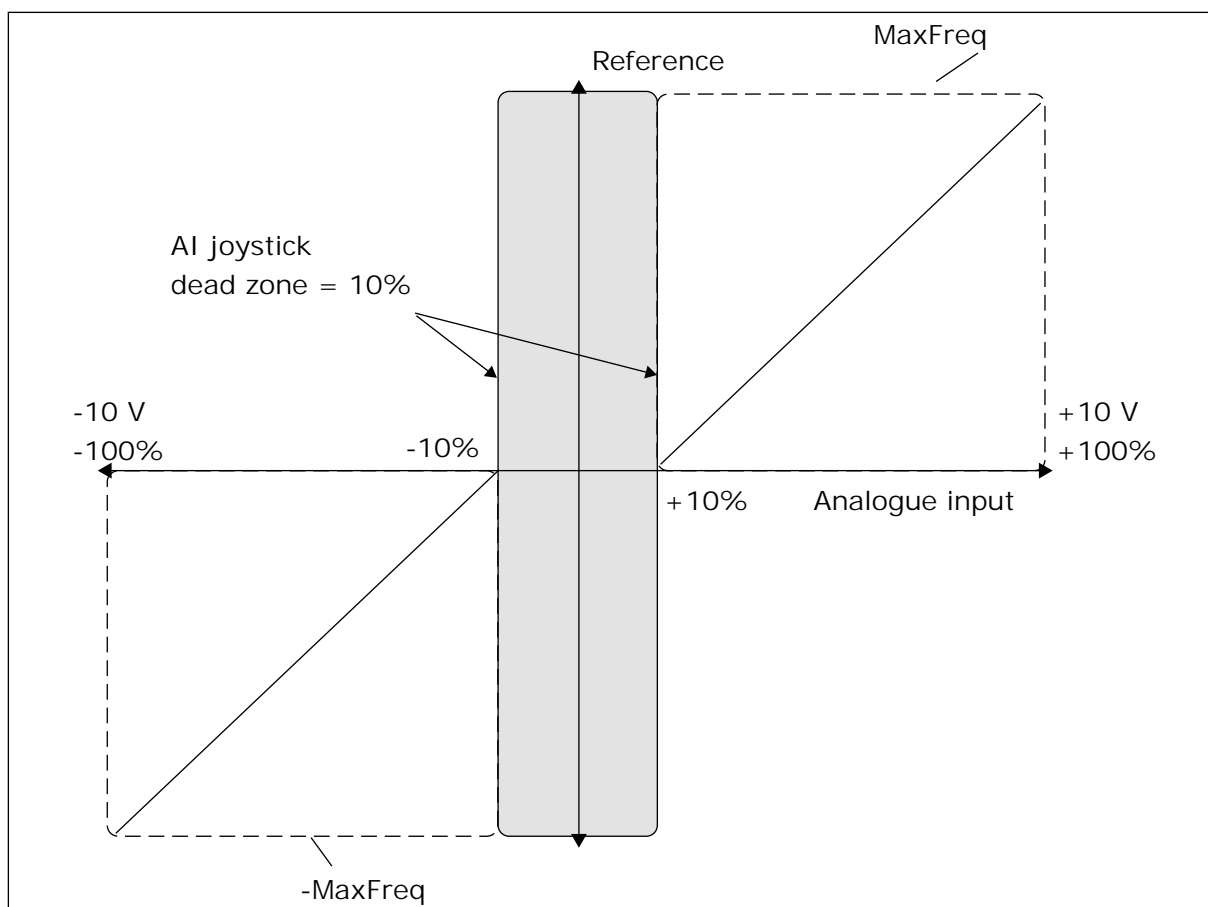

Fig. 38: The Joystick function

P3.3.5.3 JOYSTICK SLEEP ZONE (ID 385)

P3.3.5.3 JOYSTICK SLEEP DELAY (ID 386)

If the joystick reference stays in the set sleep zone for longer than the sleep delay, the drive stops and the sleep mode activates.

The value 0 of the parameter tells that the sleep delay is not used.



NOTE!

The Joystick sleep function is available only when you use a joystick to control the frequency reference.

9.5 JOGGING PARAMETERS

Use the Jogging function to override the normal control momentarily. You can use this function, for example, to control the process slowly to a special status or position during maintenance. You do not have to change the control place or other parameters.

Only when the drive is in stop state, it is possible to activate the Jogging function. You can use 2 bi-directional frequency references. You can activate the Jogging function from the

fieldbus or by digital input signals. The Jogging function has a ramp time that is used always when jogging is active.

The Jogging function starts the drive at the set reference. A new start command is not necessary. The control place does not have an effect on this.

You can activate the Jogging function from the fieldbus in bypass mode with Control Word bits 10 and 11.

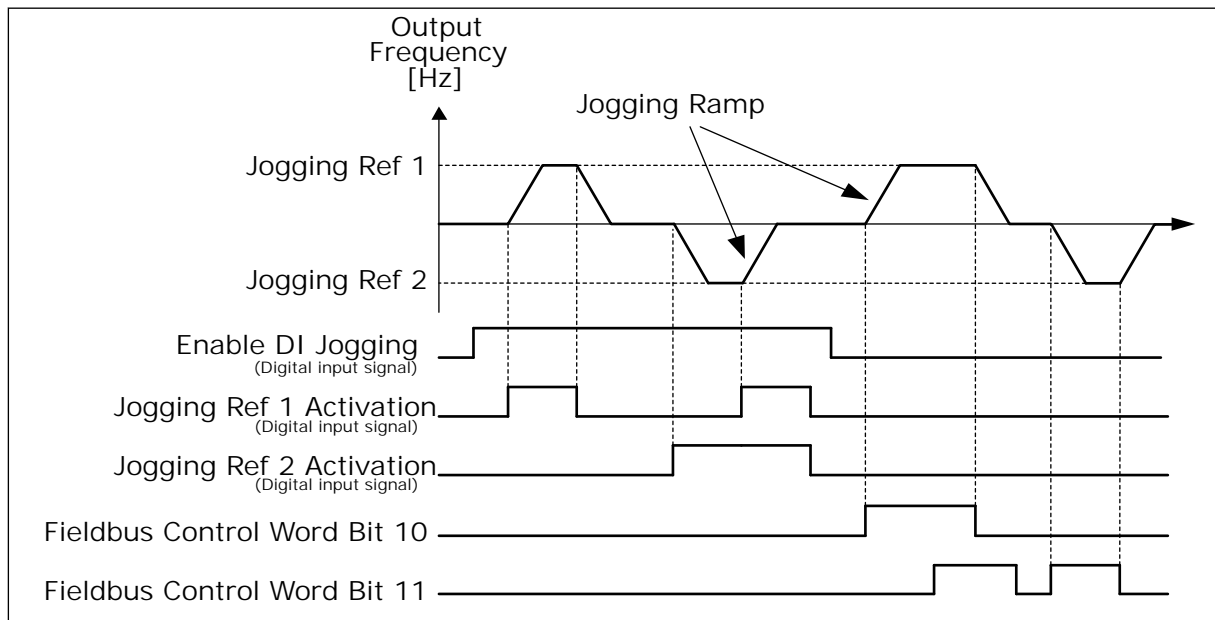

Fig. 39: The Jogging parameters

P3.3.6.1 ENABLE DI JOGGING (ID 532)

This parameter gives the digital input signal that is used to enable jogging commands from digital inputs. This signal does not have an effect on the jogging commands that come from Fieldbus.

P3.3.6.2 JOGGING REFERENCE 1 ACTIVATION (ID 530)

P3.3.6.3 JOGGING REFERENCE 2 ACTIVATION (ID 531)

These parameters give the digital input signals that are used to set the frequency reference for Jogging function and make the drive start. You can use these digital input signals only when Enable DI Jogging is active.



NOTE!

If you activate Enable DI Jogging and this digital input, the drive starts.



NOTE!

If the 2 activation signals are active at the same time, the drive stops.

P3.3.6.4 JOGGING REFERENCE 1 (ID 1239)

P3.3.6.5 JOGGING REFERENCE 2 (ID 1240)

With the parameters P3.3.6.4 and P3.3.6.5, you can set the frequency references for the jogging function. The references are bi-directional. A reverse command does not have an effect on the direction of the jogging references. The reference for the forward direction has a positive value, and the reference for the reverse direction has a negative value. You can activate the jogging function with digital input signals or from Fieldbus in bypass mode with Control Word bits 10 and 11.

9.6 RAMPS AND BRAKES SETUP

P3.4.1.1 RAMP 1 SHAPE (ID 500)

P3.4.2.1 RAMP 2 SHAPE (ID 501)

With the parameters Ramp 1 Shape and Ramp 2 Shape, you can make smoother the start and the end of the acceleration and deceleration ramps. If you set the value to 0.0%, you get a linear ramp shape. The acceleration and deceleration act immediately to the changes in the reference signal.

When you set the value between 1.0% and 100.0%, you get an S-shaped acceleration or deceleration ramp. Use this function to reduce mechanical erosion of the parts and current spikes when the reference changes. You can modify the acceleration time with parameters P3.4.1.2 (Acceleration Time 1) and P3.4.1.3 (Deceleration Time 1).

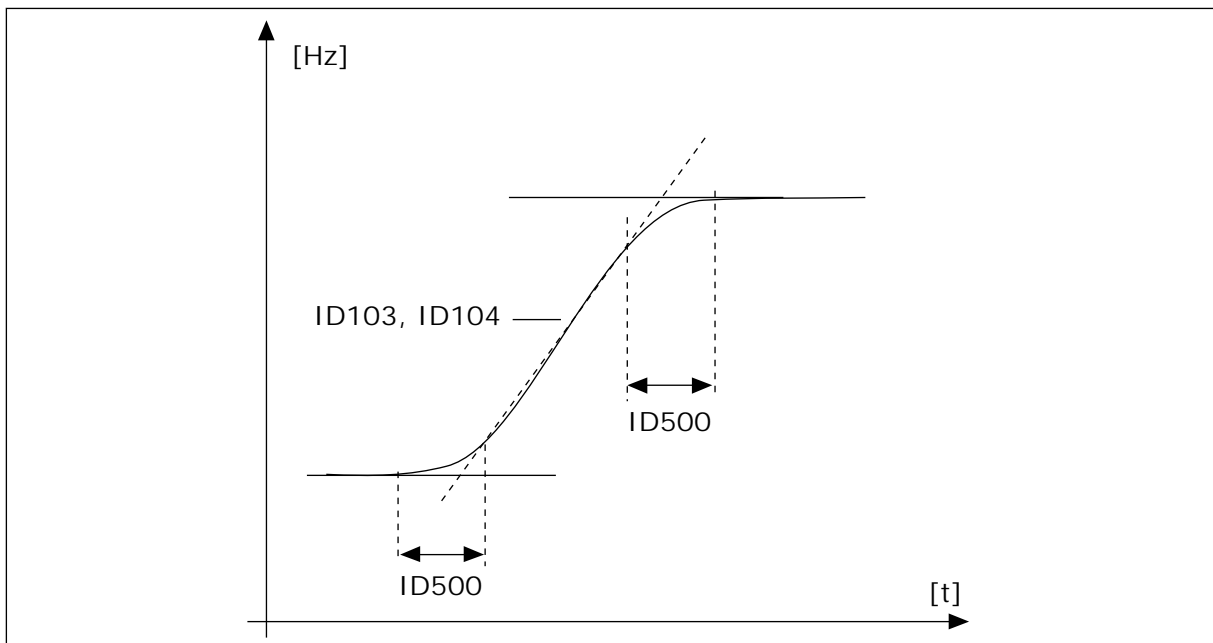

Fig. 40: The acceleration/deceleration curve (S-shaped)

P3.4.5.1 FLUX BRAKING (ID 520)

As an alternative to DC braking, you can use flux braking. Flux braking increases the braking capacity in conditions where additional brake resistors are not necessary.

When braking is necessary, the system decreases the frequency and increases the flux in the motor. This increases the capacity of the motor to brake. The motor speed is controlled during braking.

You can enable and disable Flux Braking.



CAUTION!

Use the braking only intermittently. Flux braking converts energy into heat and can cause damage to the motor.

9.7 I/O CONFIGURATION

9.7.1 PROGRAMMING OF DIGITAL AND ANALOGUE INPUTS

The programming of inputs of the AC drive is flexible. You can freely use the available inputs of the standard and optional I/O for different functions.

It is possible to expand the available capacity of I/O with option boards. You can install the option boards in the slots C, D and E. You can find more data on the installation of option boards in the Installation manual.

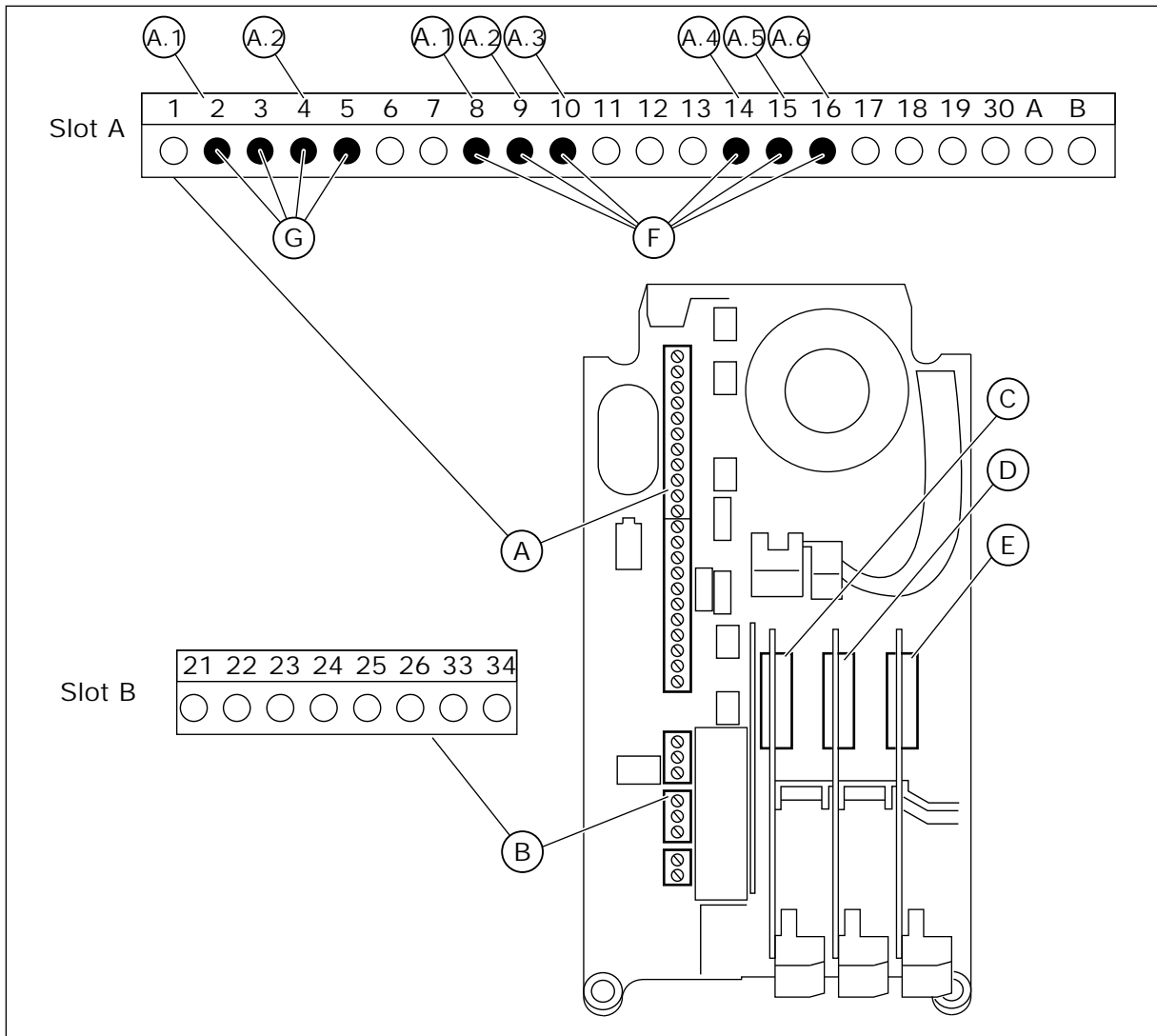

Fig. 41: The option board slots and programmable inputs

- A. Standard board slot A and its terminals
- B. Standard board slot B and its terminals
- C. Option board slot C
- D. Option board slot D
- E. Option board slot E
- F. Programmable digital inputs (DI)
- G. Programmable analogue inputs (AI)

9.7.1.1 Programming of digital inputs

You can find the applicable functions for digital inputs as parameters in parameter group M3.5.1. To give a digital input to a function, set a value to the correct parameter. The list of applicable functions shows in Table *Table 50 Digital input settings*.

Example

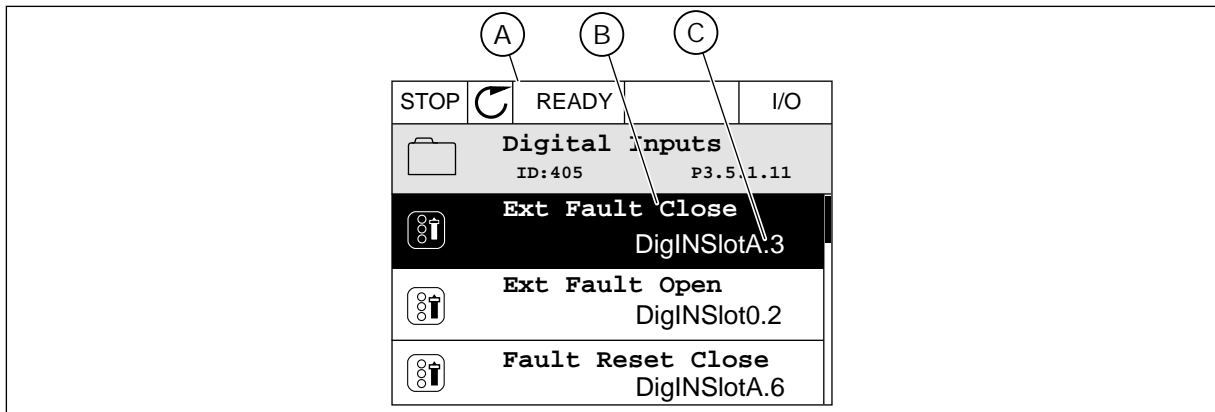

Fig. 42: The Digital inputs menu in the graphical display

- A. The graphical display
- B. The name of the parameter, that is, the function
- C. The value of the parameter, that is, the set digital input

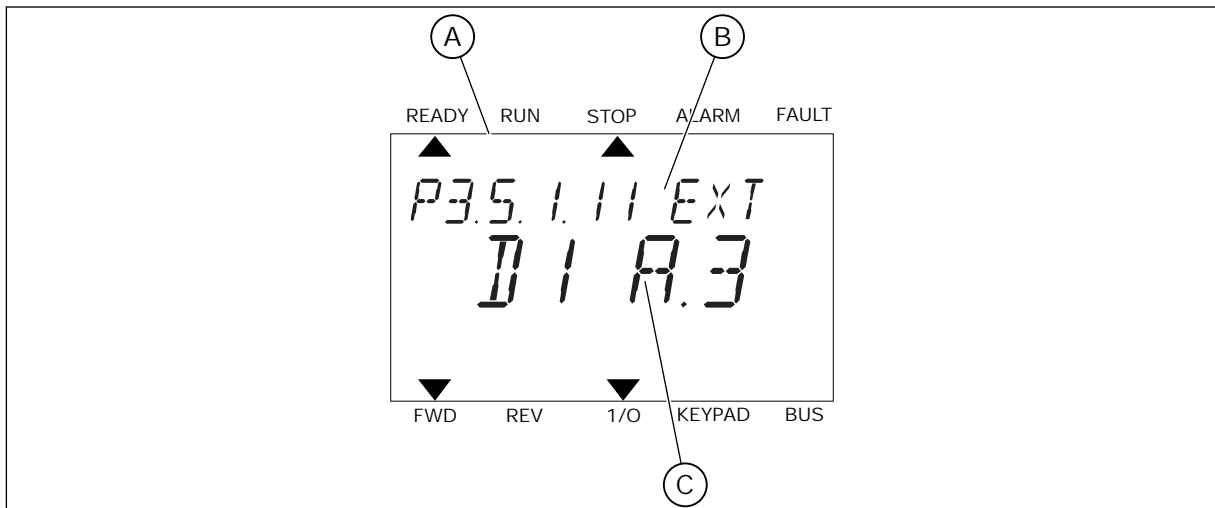

Fig. 43: The Digital inputs menu in the text display

- A. The text display
- B. The name of the parameter, that is, the function
- C. The value of the parameter, that is, the set digital input

In the standard I/O board compilation, there are 6 digital inputs available: the slot A terminals 8, 9, 10, 14, 15 and 16.

Input type (graphical display)	Input type (text display)	Slot	Input #	Explanation
DigIN	dl	A	1	Digital input #1 (terminal 8) on a board in Slot A (standard I/O board).
DigIN	dl	A	2	Digital input #2 (terminal 9) on a board in Slot A (standard I/O board).
DigIN	dl	A	3	Digital input #3 (terminal 10) on a board in Slot A (standard I/O board).
DigIN	dl	A	4	Digital input #4 (terminal 14) on a board in Slot A (standard I/O board).
DigIN	dl	A	5	Digital input #5 (terminal 15) on a board in Slot A (standard I/O board).
DigIN	dl	A	6	Digital input #6 (terminal 16) on a board in Slot A (standard I/O board).

The function External Fault Close, the location of which is the menu M3.5.1, is parameter P3.5.1.11. It gets the default value DigIN SlotA.3 in the graphical display, and dl A.3 in the text display. After this selection, a digital signal to the digital input DI3 (terminal 10) controls External Fault Close.

Index	Parameter	Default	ID	Description
P3.5.1.11	External fault close	DigIN SlotA.3	405	FALSE = OK TRUE = External fault

To change the input from DI3 to, for example, DI6 (terminal 16) on the standard I/O, obey these instructions.

PROGRAMMING IN THE GRAPHICAL DISPLAY

- 1 Make a selection of a parameter. To go into the Edit mode, push the arrow button Right.

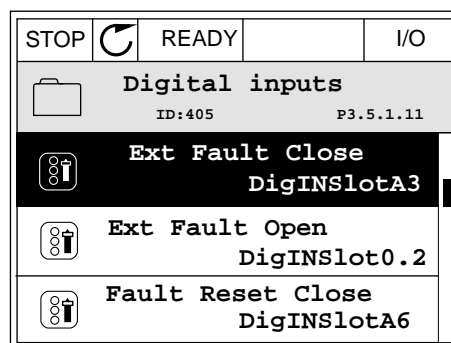

- In the Edit mode, the slot value DigIN SlotA is underlined and blinks. If you have more digital inputs available in your I/O, for example, because of option boards in slots C, D or E, make a selection of them.

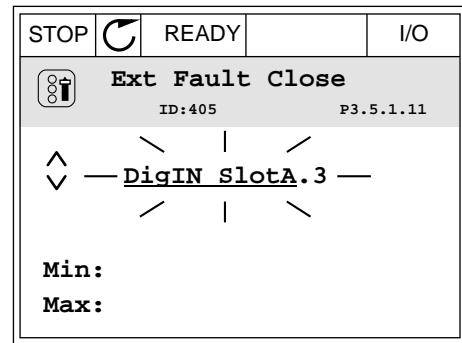

- To activate the terminal 3, push the arrow button Right again.

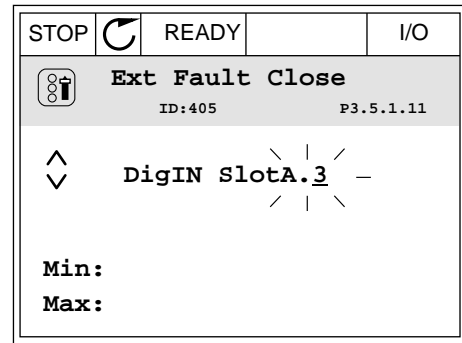

- To change the terminal to 6, push the arrow button Up 3 times. Accept the change with the OK button.

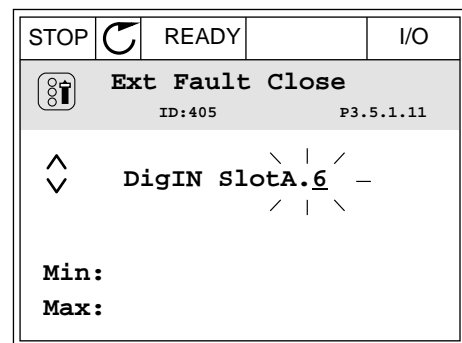

- If the digital input DI6 was already used for some other function, a message shows on the display. Change one of these selections.

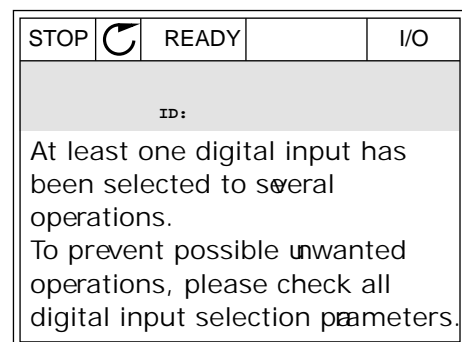

PROGRAMMING IN THE TEXT DISPLAY

- 1 Make a selection of a parameter. To go into the Edit mode, push the OK button.

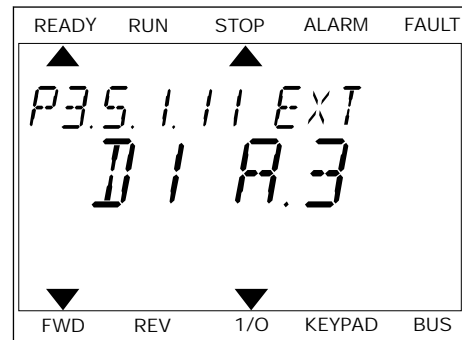

- 2 In the Edit mode, the letter D blinks. If you have more digital inputs available in your I/O, for example, because of option boards in slots C, D or E, make a selection of them.

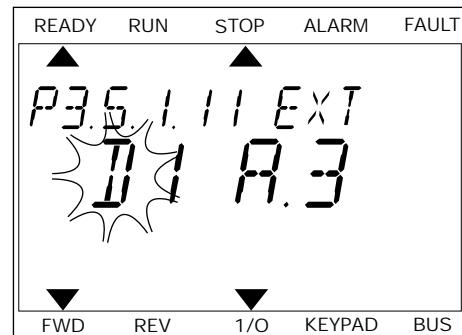

- 3 To activate the terminal 3, push the arrow button Right again. The letter D stops blinking.



- 4 To change the terminal to 6, push the arrow button Up 3 times. Accept the change with the OK button.

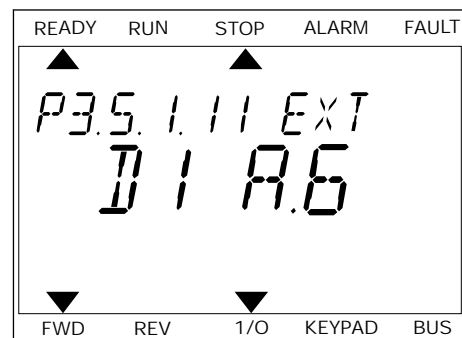

- 5 If the digital input DI6 was already used for some other function, a message scrolls on the display. Change one of these selections.

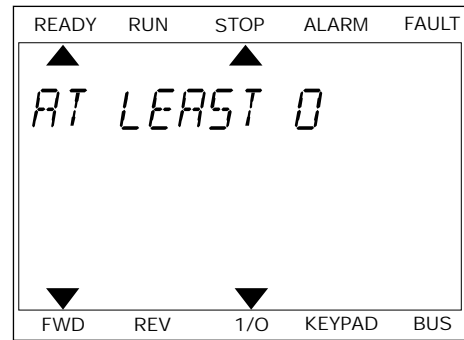

After the steps, a digital signal to the digital input DI6 controls the function External Fault Close.

The value of a function can be DigIN Slot0.1 (in the graphical display) or dl 0.1 (in the text display). In these conditions, you did not give a terminal to the function, or the the input was set to be always OPEN. This is the default value of most of parameters in the group M3.5.1. On the other hand, some inputs have the default value always CLOSED. Their value shows DigIN Slot0.2 in the graphical display and dl 0.2 in the text display.



NOTE!

You can also give time channels to digital inputs. There is more data about it in Table *Table 86 Sleep function settings*.

9.7.1.2 Programming of analogue inputs

You can make a selection of the target input for the signal of the analogue frequency reference from the available analogue inputs.

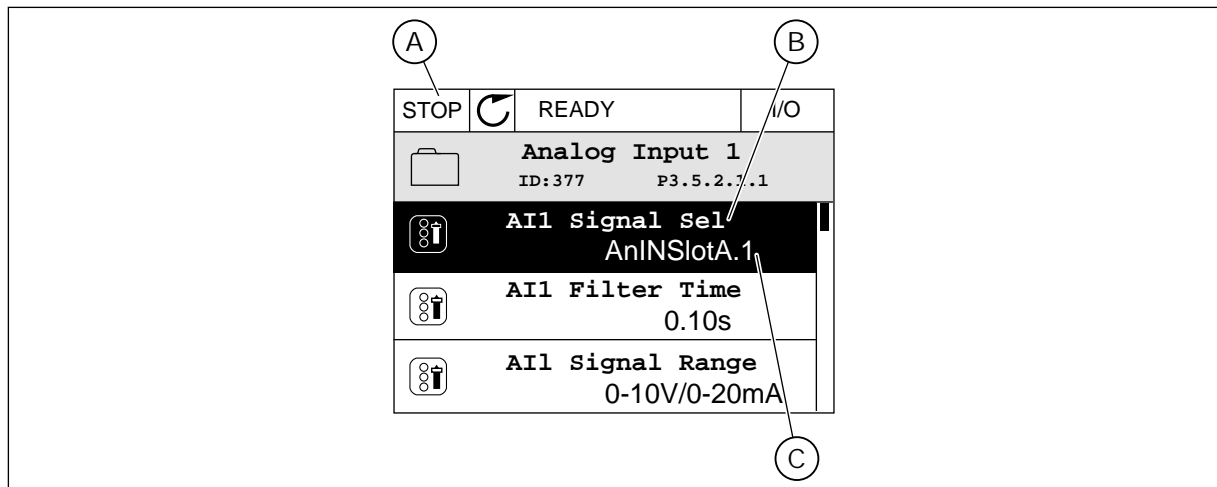

Fig. 44: The Analogue inputs menu in the graphical display

- A. The graphical display
- B. The name of the parameter
- C. The value of the parameter, that is, the set analogue input

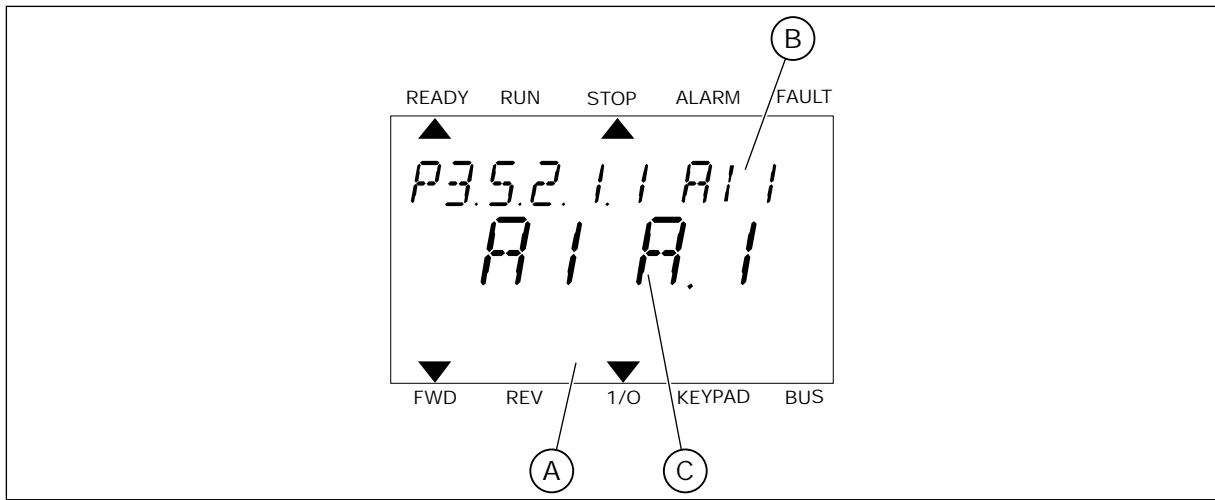

Fig. 45: The Analogue inputs menu in the text display

- A. The text display
- B. The name of the parameter
- C. The value of the parameter, that is, the set analogue input

In the standard I/O board compilation, there are 2 analogue inputs available: the slot A terminals 2/3 and 4/5.

Input type (graphical display)	Input type (text display)	Slot	Input #	Explanation
AnIN	AI	A	1	Analogue input #1 (terminals 2/3) on a board in Slot A (standard I/O board).
AnIN	AI	A	2	Analogue input #2 (terminals 4/5) on a board in Slot A (standard I/O board).

The location of the parameter P3.5.2.1.1 AI1 Signal Selection is the menu M3.5.2.1. The parameter gets the default value AnIN SlotA.1 in the graphical display or AI A.1 in the text display. The target input for the signal of the analogue frequency reference AI1 is then the analogue input in the terminals 2/3. Use the dip switches to set the signal to be voltage or current. See the Installation manual for more data.

Index	Parameter	Default	ID	Description
P3.5.2.1.1	AI1 Signal Selection	AnIN SlotA.1	377	

To change the input from AI1 to, for example, the analogue input on your option board in slot C, obey these instructions.

PROGRAMMING OF ANALOGUE INPUTS IN THE GRAPHICAL DISPLAY

- 1 To make a selection of the parameter, push the arrow button Right.

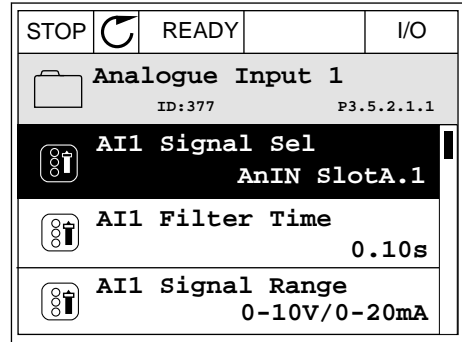

- 2 In the Edit mode, the value AnIN SlotA is underlined and blinks.

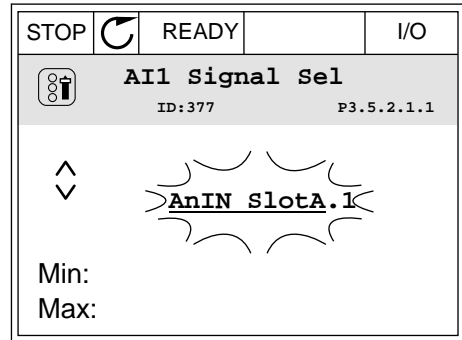

- 3 To change the value to AnIN SlotC, push the arrow button Up. Accept the change with the OK button.

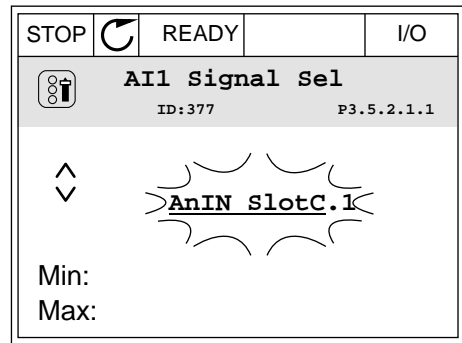

PROGRAMMING OF ANALOGUE INPUTS IN THE TEXT DISPLAY

- 1 To make a selection of the parameter, push the OK button.

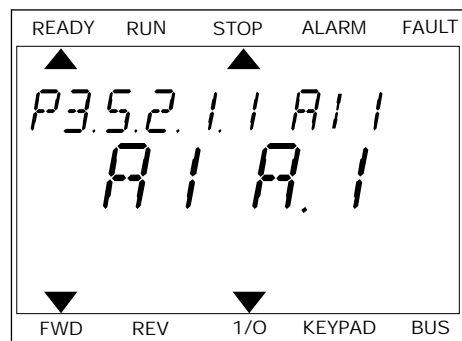

- 2 In the Edit mode, the letter A blinks.

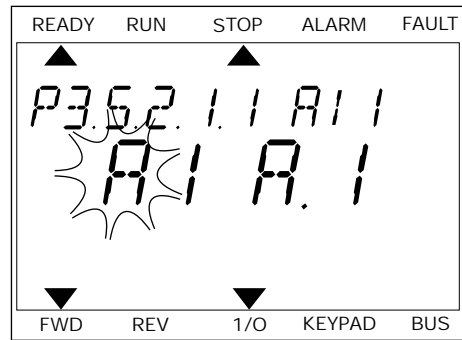

- 3 To change the value to C, push the arrow button Up. Accept the change with the OK button.

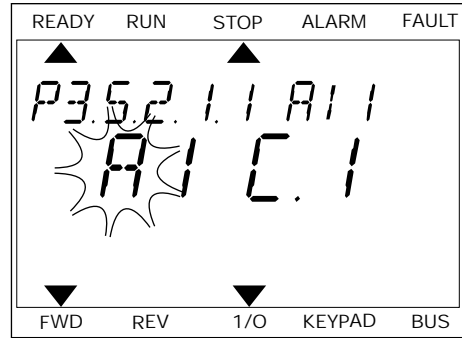

9.7.1.3 Descriptions of signal sources

Source	Function
Slot0.#	<p>Digital inputs:</p> <p>You can use this function to set a digital signal to be in a constant FALSE or TRUE state. The manufacturer set some signals so that they are always in the TRUE state, for example parameter P3.5.1.15 (Run Enable). The Run Enable signal is always on if you do not change it.</p> <p># = 1: Always FALSE # = 2-10: Always TRUE</p> <p>Analogue inputs (used for testing purposes):</p> <p># = 1: Analogue input = 0% of the signal strength # = 2: Analogue input = 20% of the signal strength # = 3: Analogue input = 30% of the signal strength etc. # = 10: Analogue input = 100% of the signal strength</p>
SlotA.#	Number (#) agrees to a digital input in slot A.
SlotB.#	Number (#) agrees to a digital input in slot B.
SlotC.#	Number (#) agrees to a digital input in slot C.
SlotD.#	Number (#) agrees to a digital input in slot D.
SlotE.#	Number (#) agrees to a digital input in slot E.
TimeChannel.#	1=Time Channel1, 2=Time Channel2, 3=Time Channel3
FieldbusCW.#	Number (#) refers to a control word bit number.
FieldbusPD.#	Number (#) refers to the process data 1 bit number.
BlockOut.#	Number (#) refers to an output of the corresponding function block in the Drive customizer.

9.7.2 DEFAULT FUNCTIONS OF PROGRAMMABLE INPUTS

Table 119: Default functions of the programmable digital and analogue inputs

Input	Terminal(s)	Reference	Function	Parameter index
DI1	8	A.1	Control Signal 1 A	P3.5.1.1
DI2	9	A.2	Control Signal 2 A	P3.5.1.2
DI3	10	A.3	External Fault Close	P3.5.1.11
DI4	14	A.4	Preset Frequency Selection 0	P3.5.1.21
DI5	15	A.5	Preset Frequency Selection 1	P3.5.1.22
DI6	16	A.6	Fault Reset Close	P3.5.1.13
AI1	2/3	A.1	AI1 Signal Selection	P3.5.2.1.1
AI2	4/5	A.2	AI2 Signal Selection	P3.5.2.2.1

9.7.3 DIGITAL INPUTS

The parameters are functions that you can connect to a digital input terminal. The text *DigIn Slot A.2* means the second input on the slot A. It is also possible to connect the functions to time channels. The time channels work as terminals.

You can monitor the statuses of the digital inputs and the digital outputs in the Multimonitoring view.

P3.5.1.15 RUN ENABLE (ID 407)

When the contact is OPEN, the start of the motor is disabled.
When the contact is CLOSED, the start of the motor is enabled.

To stop, the drive obeys the value of P3.2.5 Stop Function. The follower drive will always coast to stop.

P3.5.1.16 RUN INTERLOCK 1 (ID 1041)

P3.5.1.17 RUN INTERLOCK 2 (ID 1042)

If an interlock is active, the drive cannot start.

You can use this function to prevent the start of the drive when the damper is closed. If you activate an interlock during the operation of the drive, the drive stops.

P3.5.1.49 PARAMETER SET 1/2 SELECTION (ID 496)

This parameter defines the digital input, which can be used to select between Parameter Set 1 and Set 2. This function is enabled if any other slot than 'DigIN Slot0' is selected to this parameter. The parameter set selection is allowed only when the drive is stopped.

Contact Open = Parameter Set 1 is loaded as the active set
Contact Closed = Parameter Set 2 is loaded as the active set

**NOTE!**

Parameter values are stored to Set 1 and Set 2 by parameters B6.5.4 Save to Set 1 and B6.5.4 Save to Set 2. These parameters can be used either from keypad or Vacon Live pc-tool.

P3.5.1.50 (P3.9.9.1) USER DEFINED FAULT 1 ACTIVATION (ID 15523)

Use this parameter to set the digital input signal that activates User Defined Fault 1 (Fault ID 1114).

P3.5.1.51 (P3.9.10.1) USER DEFINED FAULT 2 ACTIVATION (ID 15524)

Use this parameter to set the digital input signal that activates User Defined Fault 2 (Fault ID 1115).

9.7.4 ANALOGUE INPUTS

P3.5.2.1.2 AI1 SIGNAL FILTER TIME (ID 378)

This parameter filters out disturbances in the analogue input signal. To activate this parameter, give it a value that is bigger than 0.

**NOTE!**

A long filter time makes the regulation response slow.

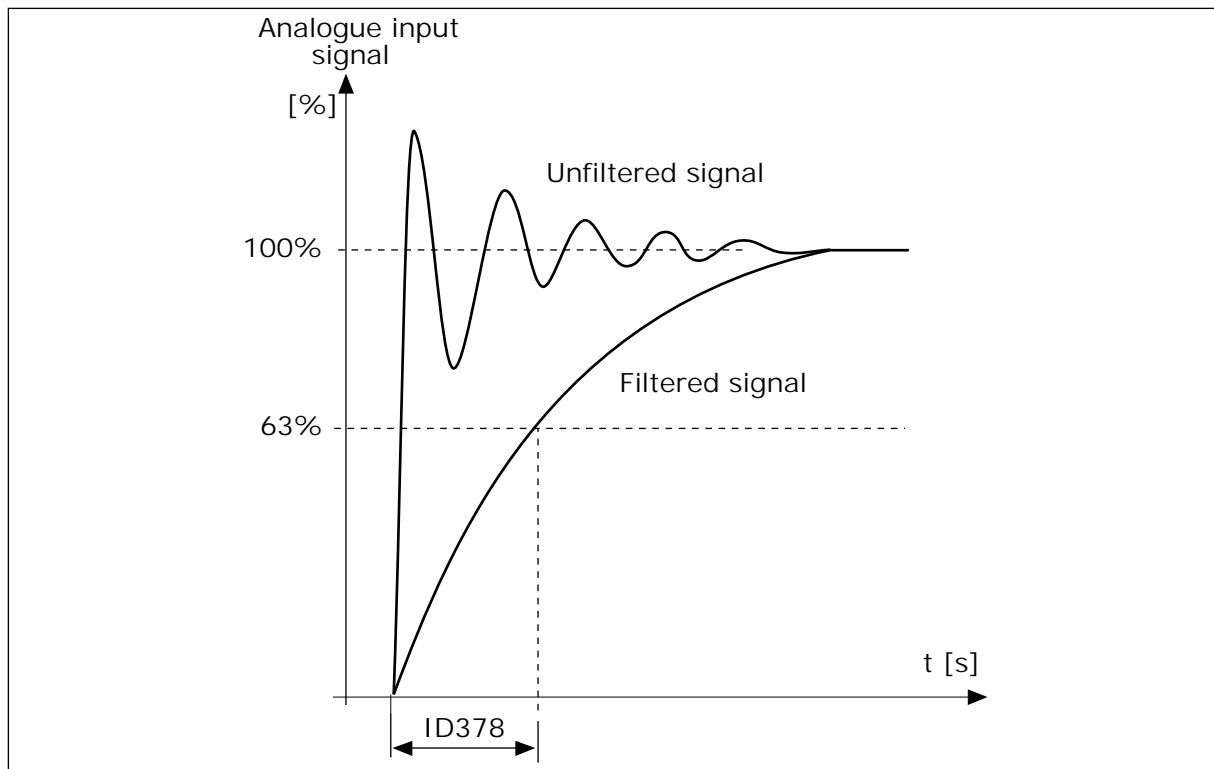

Fig. 46: The AI1 signal filtering

P3.5.2.1.3 AI1 SIGNAL RANGE (ID 379)

To set the type of the analogue input signal (current or voltage), use the dip switches on the control board. See more in the Installation manual.

It is also possible to use the analogue input signal as frequency reference. The selection of the value 0 or 1 change the scaling of the analogue input signal.

Selection number	Selection name	Description
0	0...10V / 0...20mA	The range of the analogue input signal is 0...10V or 0...20mA (the dip switch settings on the control board tell which one). The input signal is 0...100%.

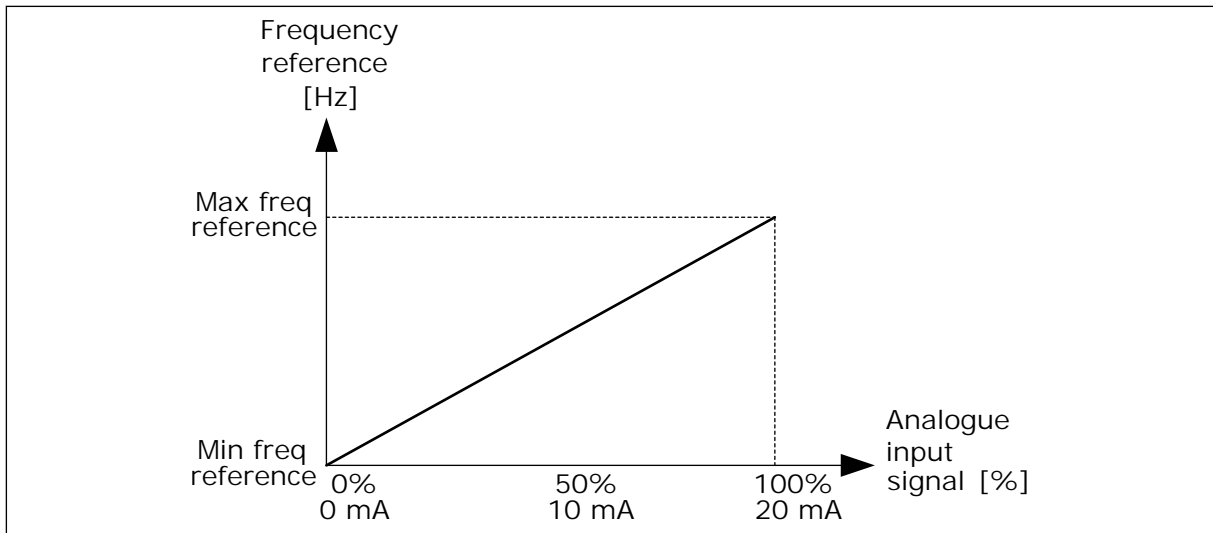

Fig. 47: The analogue input signal range, selection 0

Selection number	Selection name	Description
1	2...10V / 4...20mA	The range of the analogue input signal is 2...10V or 4...20mA (the dip switch settings on the control board tell which one). The input signal is 20...100%.

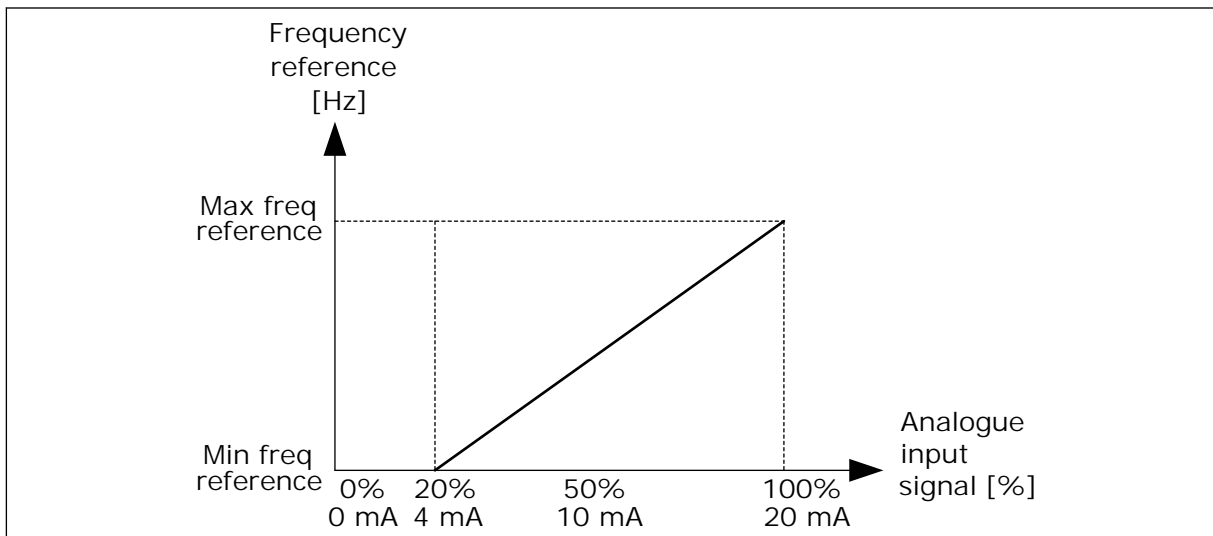

Fig. 48: The analogue input signal range, selection 1

P3.5.2.1.4 AI1 CUSTOM. MIN (ID 380)

P3.5.2.1.5 AI1 CUSTOM. MAX (ID 381)

The parameters P3.5.2.1.4 and P3.5.2.1.5 let you adjust the range of the analogue input signal between -160 and 160% freely.

For example, you can use the analogue input signal as frequency reference, and set these 2 parameters between 40 and 80%. In these conditions, the frequency reference changes between the Minimum frequency reference and the Maximum frequency reference, and the analogue input signal changes between 8 and 16 mA.

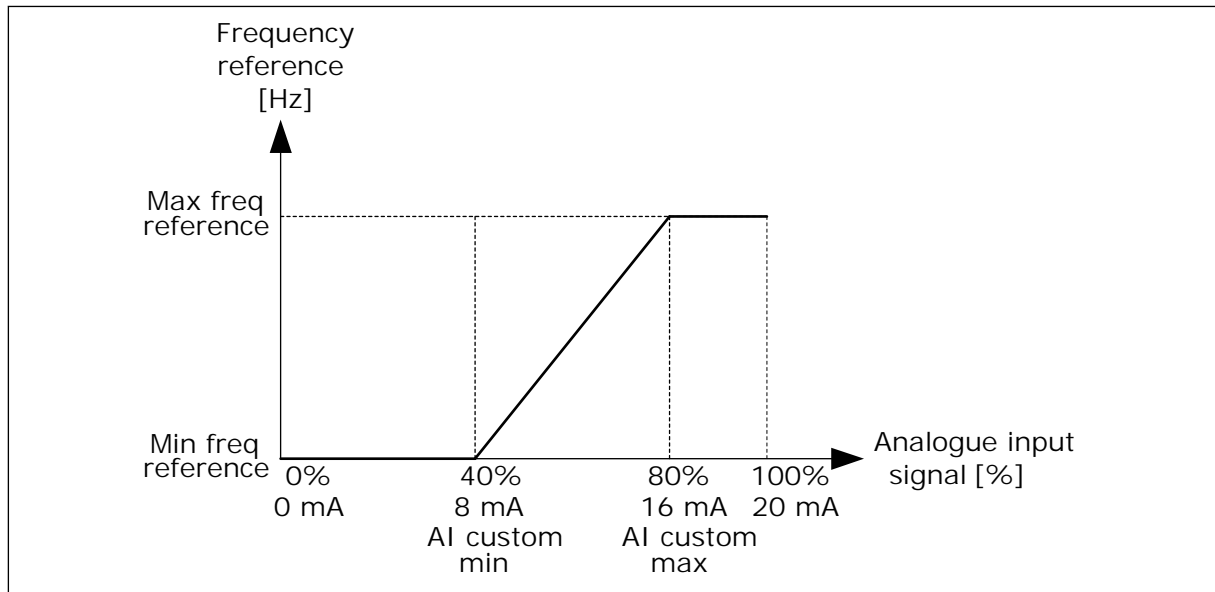

Fig. 49: AI1 signal custom. min/max

P3.5.2.1.6 AI1 SIGNAL INVERSION (ID 387)

In the inversion on the analogue input signal, the curve of the signal becomes the opposite.

It is possible to use the analogue input signal as frequency reference. The selection of the value 0 or 1 change scaling of the analogue input signal.

Selection number	Selection name	Description
0	Normal	No inversion. The value 0% of the analogue input signal agrees to the Minimum Frequency Reference. The value 100% of the the analogue input signal agrees to the Maximum Frequency Reference.

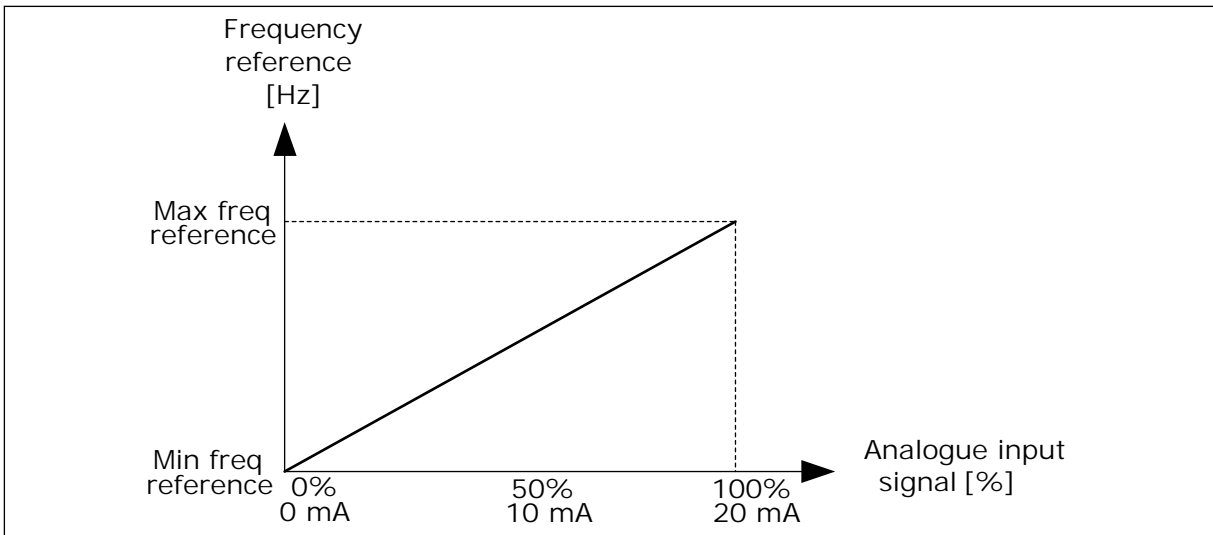

Fig. 50: AI1 signal inversion, selection 0

Selection number	Selection name	Description
1	Inverted	Signal inversion. The value 0% of the analogue input signal agrees to the Maximum Frequency Reference. The value 100% of the analogue input signal agrees to the Minimum Frequency Reference.

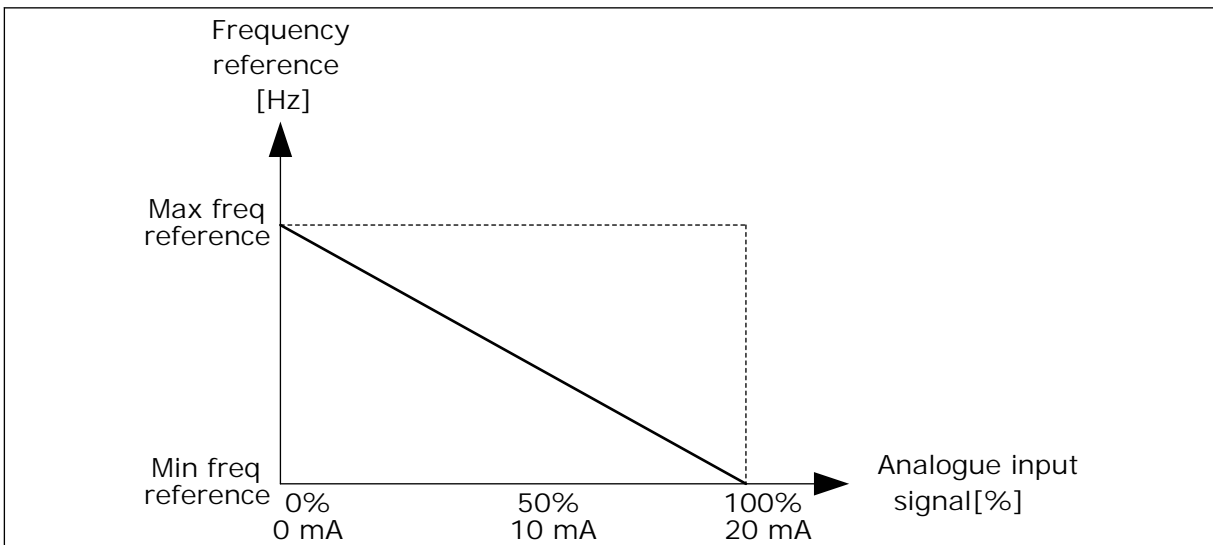

Fig. 51: AI1 signal inversion, selection 1

9.7.5 DIGITAL OUTPUTS

P3.5.3.2.1 BASIC R01 FUNCTION (ID 11001)

Table 120: The output signals through R01

Selection number	Selection name	Description
0	Not used	The output is not used.
1	Ready	The AC drive is ready to operate.
2	Run	The AC drive operates (the motor runs).
3	General fault	A fault trip occurred.
4	General fault inverted	A fault trip did not occur.
5	General alarm	An alarm occurred.
6	Reversed	The reverse command is given.
7	At speed	The output frequency has become the same as the set frequency reference.
8	Thermistor fault	A thermistor fault occurred.
9	Motor regulator activated	One of the limit regulators (for example current limit or torque limit) is activated.
10	Start signal active	The start command of the drive is active.
11	Keypad control active	The selection is keypad control (the active control place is keypad).
12	I/O control B active	The selection is I/O control place B (the active control place is I/O B).
13	Limit supervision 1	The limit supervision activates if the signal value goes below or above the set supervision limit (P3.8.3 or P3.8.7).
14	Limit supervision 2	
15	Fire mode active	The Fire mode function is active.
16	Jogging active	The Jogging function is active.
17	Preset Frequency active	The selection of preset frequency was made with digital input signals.
18	Quick Stop active	The Quick stop function is activated.
19	PID in Sleep mode	The PID controller is in the sleep mode.
20	PID Soft Fill activated	The Soft fill function of the PID controller is activated.
21	PID feedback supervision	The feedback value of the PID controller is not in the supervision limits.

Table 120: The output signals through RO1

Selection number	Selection name	Description
22	ExtPID feedback supervision	The External PID controller feedback value is not in the supervision limits.
23	Input pressure alarm	The input pressure of the pump is below the value that was set with parameter P3.13.9.7.
24	Frost protection alarm	The measured temperature of the pump is below the level that was set with parameter P3.13.10.5.
25	Motor 1 control	The contactor control for the Multi-pump function.
26	Motor 2 control	The contactor control for the Multi-pump function.
27	Motor 3 control	The contactor control for the Multi-pump function.
28	Motor 4 control	The contactor control for the Multi-pump function.
29	Motor 5 control	The contactor control for the Multi-pump function.
30	Motor 6 control	The contactor control for the Multi-pump function.
31	Time channel 1	The status of Time channel 1.
32	Time channel 2	The status of Time channel 2.
33	Time channel 3	The status of Time channel 3.
34	Fieldbus Control Word bit 13	The digital (relay) output control from the Fieldbus control word bit 13.
35	Fieldbus Control Word bit 14	The digital (relay) output control from the Fieldbus control word bit 14.
36	Fieldbus Control Word bit 15	The digital (relay) output control from the Fieldbus control word bit 15.
37	Fieldbus Process Data In1 bit 0	The digital (relay) output control from the Fieldbus Process Data In1, bit 0.
38	Fieldbus Process Data In1 bit 1	The digital (relay) output control from the Fieldbus Process Data In1, bit 1.
39	Fieldbus Process Data In1 bit 2	The digital (relay) output control from the Fieldbus Process Data In1, bit 2.
40	Maintenance counter 1 alarm	The maintenance counter reached the alarm limit that is set with parameter P3.16.2.
41	Maintenance counter 1 fault	The maintenance counter reached the alarm limit that is set with parameter P3.16.3.
42	Mechanical brake control	The Open mechanical brake command.

Table 120: The output signals through RO1

Selection number	Selection name	Description
43	Mechanical brake control (Inverted)	The Open mechanical brake command (inverted).
44	Block Out.1	The output of the programmable Block 1. See parameter menu M3.19 Drive customizer.
45	Block Out.2	The output of the programmable Block 2. See parameter menu M3.19 Drive customizer.
46	Block Out.3	The output of the programmable Block 3. See parameter menu M3.19 Drive customizer.
47	Block Out.4	The output of the programmable Block 4. See parameter menu M3.19 Drive customizer.
48	Block Out.5	The output of the programmable Block 5. See parameter menu M3.19 Drive customizer.
49	Block Out.6	The output of the programmable Block 6. See parameter menu M3.19 Drive customizer.
50	Block Out.7	The output of the programmable Block 7. See parameter menu M3.19 Drive customizer.
51	Block Out.8	The output of the programmable Block 8. See parameter menu M3.19 Drive customizer.
52	Block Out.9	The output of the programmable Block 9. See parameter menu M3.19 Drive customizer.
53	Block Out.10	The output of the programmable Block 10. See parameter menu M3.19 Drive customizer.
54	Jockey pump control	The control signal for the external jockey pump.
55	Priming pump control	The control signal for the external priming pump.
56	Auto-cleaning active	The Pump auto-cleaning function is activated.
57	Motor Switch Open	The Motor Switch function has detected that the switch between the drive and the motor is open.
58	TEST (Always Closed)	
59	Motor preheat active	

9.7.6 ANALOGUE OUTPUTS

P3.5.4.1.1. AO1 FUNCTION (ID 10050)

The contents of the analogue output signal 1 are specified in this parameter. The scaling of the analogue output signal depends on the signal.

Selection number	Selection name	Description
0	Test 0% (Not used)	The analogue output is set to 0% or 20% so that it agrees with parameter P3.5.4.1.3.
1	TEST 100%	The analogue output is set to 100% of the signal (10V / 20mA).
2	Output frequency	The actual output frequency from 0 to Maximum frequency reference.
3	Frequency reference	The actual frequency reference from 0 to Maximum frequency reference.
4	Motor speed	The actual motor speed from 0 to Motor nominal speed.
5	Output current	The output current of the drive from 0 to Motor nominal current.
6	Motor torque	The actual motor torque from 0 to motor nominal torque (100%).
7	Motor power	The actual motor power from 0 to Motor nominal power (100%).
8	Motor voltage	The actual motor voltage from 0 to Motor nominal voltage.
9	DC-link voltage	The actual DC-link voltage 0...1000V.
10	PID Setpoint	The actual setpoint value of the PID Controller (0...100%).
11	PID Feedback	The actual feedback value of the PID Controller (0...100%).
12	PID output	The output of the PID controller (0...100%).
13	ExtPID output	The External PID controller output (0...100%).
14	Fieldbus Process Data In 1	Fieldbus Process Data In 1: 0...10000 (this agrees with 0...100.00%).
15	Fieldbus Process Data In 2	Fieldbus Process Data In 2: 0...10000 (this agrees with 0...100.00%).
16	Fieldbus Process Data In 3	Fieldbus Process Data In 3: 0...10000 (this agrees with 0...100.00%).
17	Fieldbus Process Data In 4	Fieldbus Process Data In 4: 0...10000 (this agrees with 0...100.00%).
18	Fieldbus Process Data In 5	Fieldbus Process Data In 5: 0...10000 (this agrees with 0...100.00%).
19	Fieldbus Process Data In 6	Fieldbus Process Data In 6: 0...10000 (this agrees with 0...100.00%).
20	Fieldbus Process Data In 7	Fieldbus Process Data In 7: 0...10000 (this agrees with 0...100.00%).

Selection number	Selection name	Description
21	Fieldbus Process Data In 8	Fieldbus Process Data In 8: 0...10000 (this agrees with 0...100.00%).
22	Block Out.1	The output of the programmable Block 1: 0...10000 (this agrees with 0...100.00%). See parameter menu M3.19 Drive customizer.
23	Block Out.2	The output of the programmable Block 2: 0...10000 (this agrees with 0...100.00%). See parameter menu M3.19 Drive customizer.
24	Block Out.3	The output of the programmable Block 3: 0...10000 (this agrees with 0...100.00%). See parameter menu M3.19 Drive customizer.
25	Block Out.4	The output of the programmable Block 4: 0...10000 (this agrees with 0...100.00%). See parameter menu M3.19 Drive customizer.
26	Block Out.5	The output of the programmable Block 5: 0...10000 (this agrees with 0...100.00%). See parameter menu M3.19 Drive customizer.
27	Block Out.6	The output of the programmable Block 6: 0...10000 (this agrees with 0...100.00%). See parameter menu M3.19 Drive customizer.
28	Block Out.7	The output of the programmable Block 7: 0...10000 (this agrees with 0...100.00%). See parameter menu M3.19 Drive customizer.
29	Block Out.8	The output of the programmable Block 8: 0...10000 (this agrees with 0...100.00%). See parameter menu M3.19 Drive customizer.
30	Block Out.9	The output of the programmable Block 9: 0...10000 (this agrees with 0...100.00%). See parameter menu M3.19 Drive customizer.
31	Block Out.10	The output of the programmable Block 10: 0...10000 (this agrees with 0...100.00%). See parameter menu M3.19 Drive customizer.

P3.5.4.1.4 A01 MINIMUM SCALE (ID 10053)

P3.5.4.1.5 A01 MAXIMUM SCALE (ID 10054)

You can use these 2 parameters to adjust the scaling of the analogue output signal freely. The scale is defined in process units and it depends on the selection of parameter P3.5.4.1.1 A01 Function.

For example, you can make a selection of the output frequency of the drive for the contents of the analogue output signal, and set parameters P3.5.4.1.4 and P3.5.4.1.5 between 10 and

40 Hz. Then the output frequency of the drive changes between 10 and 40 Hz, and the analogue output signal changes between 0 and 20 mA.

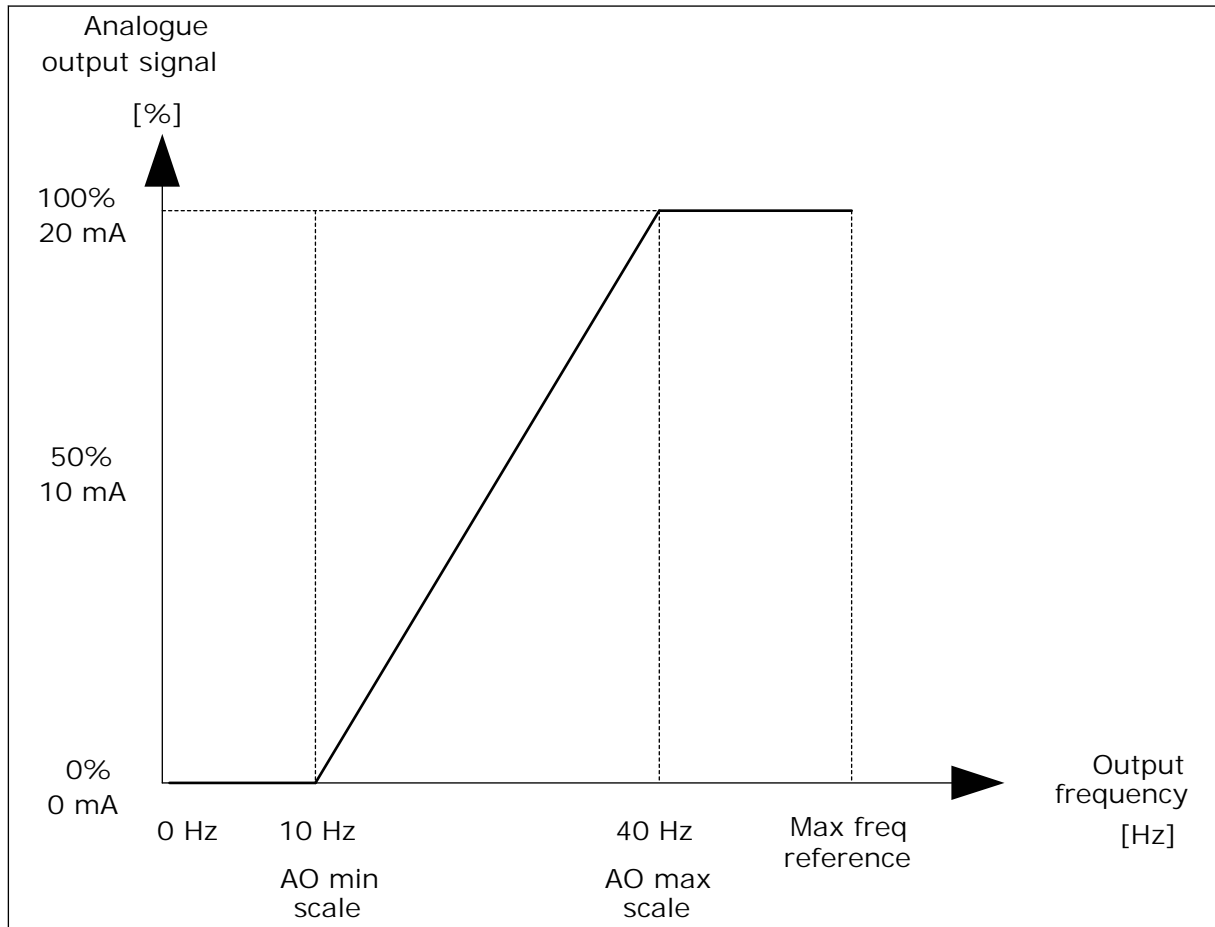

Fig. 52: The scaling of the A01 signal

9.8 PROHIBIT FREQUENCIES

In some processes it can be necessary to avoid some frequencies because they make problems of mechanical resonance. With the Prohibit frequencies function, it is possible to prevent the usage of these frequencies. When the input frequency reference increases, the internal frequency reference stays at the low limit, until the input frequency reference is above the high limit.

P3.7.1 PROHIBIT FREQUENCY RANGE 1 LOW LIMIT (ID 509)

P3.7.2 PROHIBIT FREQUENCY RANGE 1 HIGH LIMIT (ID 510)

P3.7.3 PROHIBIT FREQUENCY RANGE 2 LOW LIMIT (ID 511)

P3.7.4 PROHIBIT FREQUENCY RANGE 2 HIGH LIMIT (ID 512)

P3.7.5 PROHIBIT FREQUENCY RANGE 3 LOW LIMIT (ID 513)

P3.7.6 PROHIBIT FREQUENCY RANGE 3 HIGH LIMIT (ID 514)

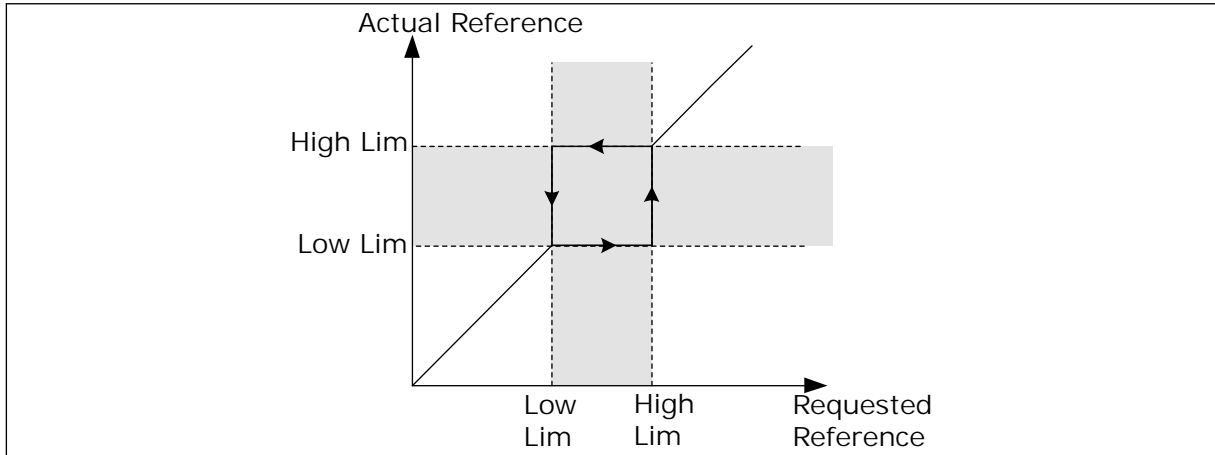

Fig. 53: The prohibited frequencies

P3.7.7 RAMP TIME FACTOR (ID 518)

The Ramp Time Factor sets the acceleration and the deceleration time when the output frequency is in a prohibited frequency range. The value of the Ramp Time Factor is multiplied with the value of P3.4.1.2 (Acceleration Time 1) or P3.4.1.3 (Deceleration Time 1). For example, the value 0.1 makes the acceleration/deceleration time ten times shorter.

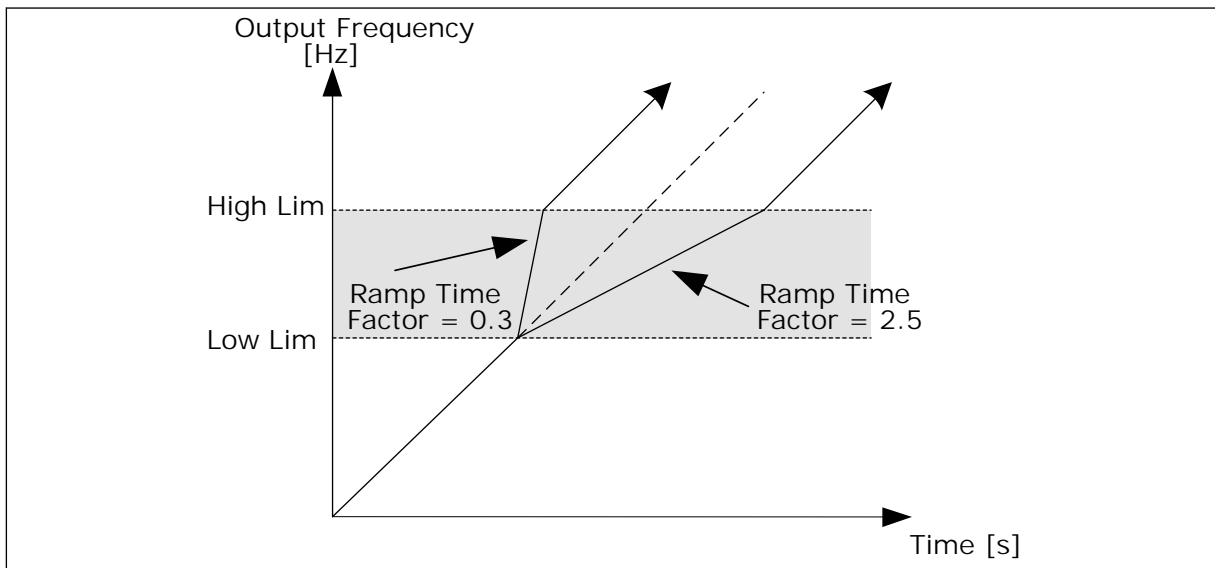

Fig. 54: The parameter Ramp Time Factor

9.9 SUPERVISIONS

P3.9.1.2 RESPONSE TO EXTERNAL FAULT (ID 701)

With this parameter, you can set the response of the drive to an external fault. If a fault occurs, the drive can show a notification of it on the display of the drive. The notification is

made in a digital input. The default digital input is DI3. You can also program the response data into a relay output.

P3.9.1.14 RESPONSE TO SAFE TORQUE OFF (STO) FAULT (ID 775)

This parameter defines the response for F30 – Safe Torque Off (Fault ID: 530).

This parameter defines drive operation when Safe Torque Off (STO) function is activated (e.g. emergency stop button has been pressed or some other STO operation has been activated).

0 = No action

1 = Alarm

2 = Fault, stop according to defined stop function P3.2.5 Stop Function

3 = Fault, stop by coasting

9.9.1 MOTOR THERMAL PROTECTIONS

The motor thermal protection prevents the motor from becoming too hot.

The AC drive can supply a current that is higher than the nominal current. The high current can be necessary to the load, and it must be used. In these conditions, there is a risk of a thermal overload. Low frequencies have a higher risk. At low frequencies, the cooling effect and the capacity of the motor decrease. If the motor has an external fan, the load reduction at low frequencies is small.

The motor thermal protection is based on calculations. The protection function uses the output current of the drive to know what is the load on the motor. If the control board is not energised, the calculations are reset.

To adjust the thermal protection of the motor, use the parameters from P3.9.2.1 to P3.9.2.5. You can monitor the thermal status of the motor on the display of the control panel. See Chapter 3 *User interfaces*.



NOTE!

If you use long motor cables (max. 100 m) with small drives (1.5 kW), the motor current that the drive measures can be much higher than the actual motor current. It is because there are capacitive currents in the motor cable.



CAUTION!

Make sure that the airflow to the motor is not blocked. If the airflow is blocked, the function does not protect the motor, and the motor can become too hot. This can cause damage to the motor.

P3.9.2.3 ZERO SPEED COOLING FACTOR (ID 706)

When the speed is 0, this function calculates the cooling factor in relation to the point where the motor operates at a nominal speed without external cooling.

The default value is set for conditions where there is no external fan. If you use an external fan, you can set the value higher than without the fan, for example at 90%.

If you change parameter P3.1.1.4 (Motor Nominal Current), parameter P3.9.2.3 is automatically set to its default value.

Although you change this parameter, it does not have an effect on the maximum output current of the drive. Only parameter P3.1.3.1 Motor Current Limit can change the maximum output current.

The corner frequency for the thermal protection is 70% of the value of the parameter P3.1.1.2 Motor Nominal Frequency.

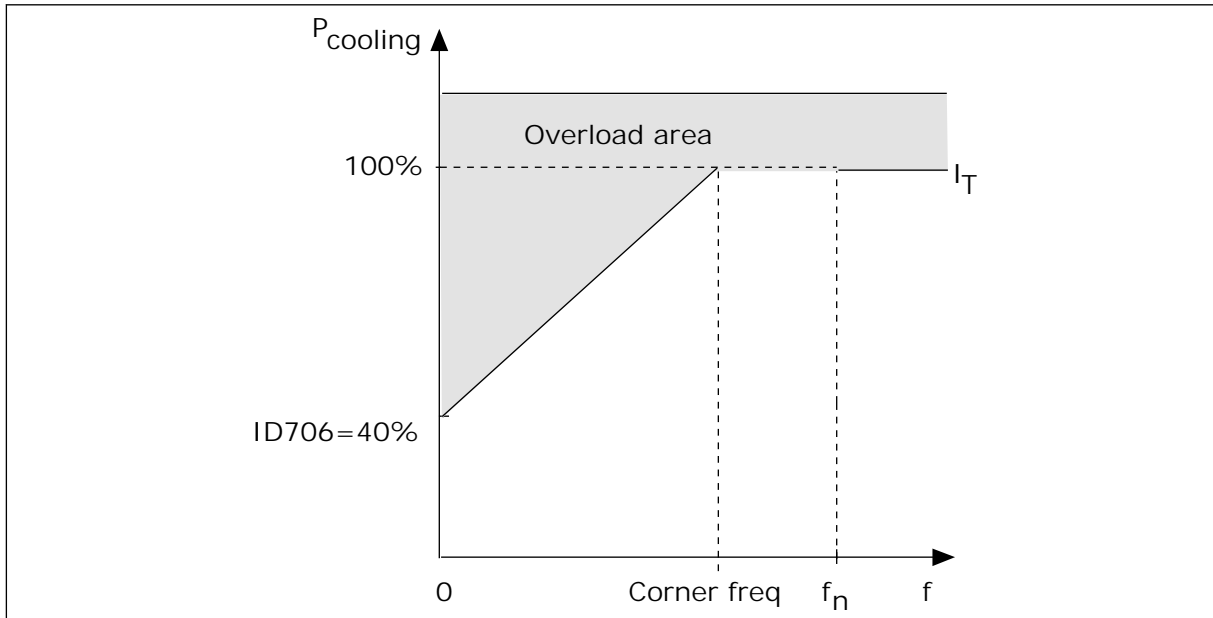

Fig. 55: The motor thermal current I_T curve

P3.9.2.4 MOTOR THERMAL TIME CONSTANT (ID 707)

The time constant is the time during which the calculated warming curve becomes 63% of its target value. The length of the time constant is in relation with the dimension of the motor. The bigger the motor, the longer the time constant.

In different motors, the motor thermal time constant is different. It also changes between different motor manufacturers. The default value of the parameter changes from dimension to dimension.

The t_6 -time is the time in seconds that the motor can safely operate at 6 times the rated current. It is possible that the motor manufacturer gives the data with the motor. If you know the t_6 of the motor, you can set the time constant parameter with its help. Usually, the motor thermal time constant in minutes is $2 \cdot t_6$. When the drive is in the STOP state, the time constant is internally increased to 3 times the set parameter value, because the cooling operates based on convection.

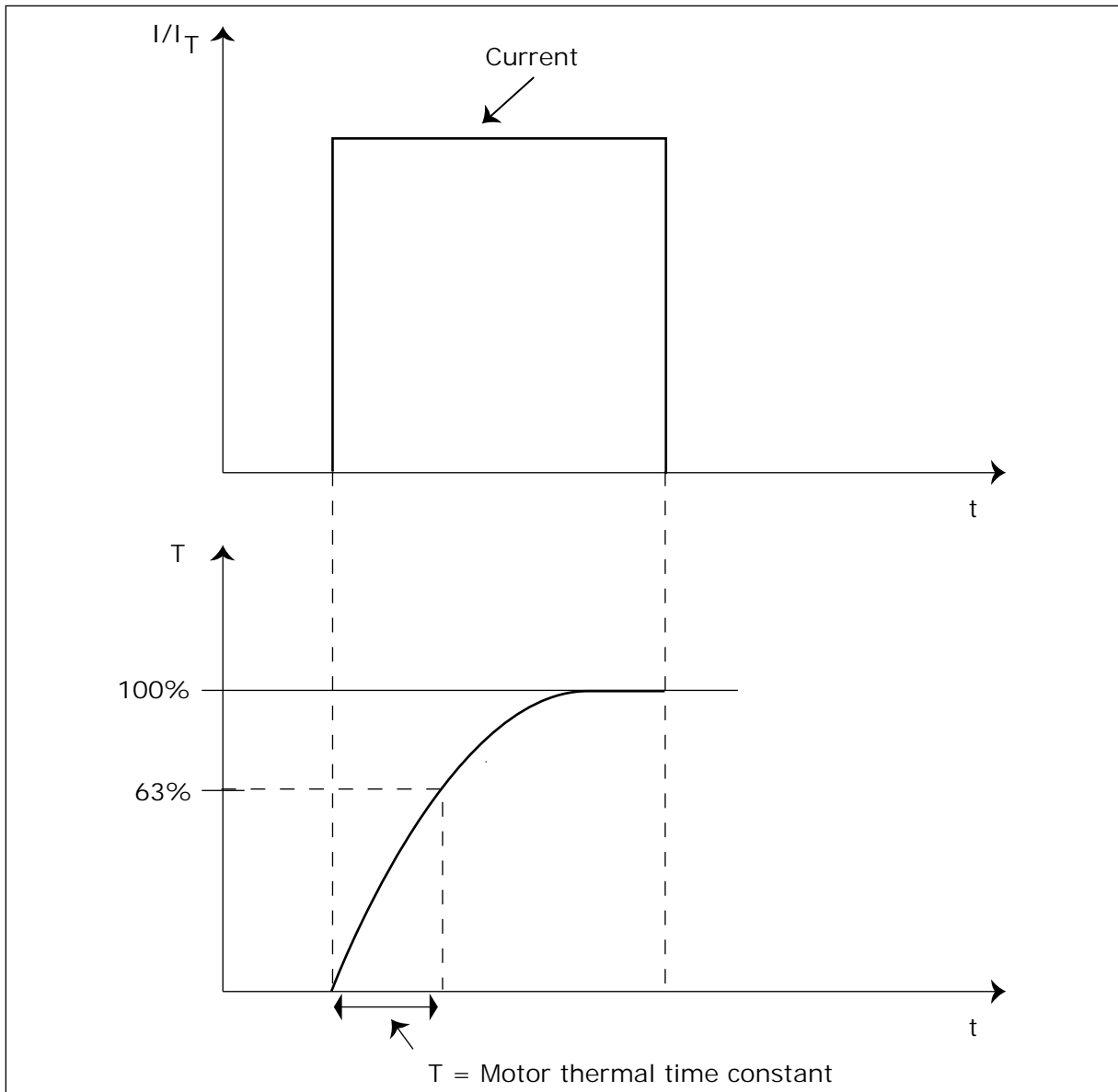

Fig. 56: The motor thermal time constant

P3.9.2.5 MOTOR THERMAL LOADABILITY (ID 708)

For example, if you set the value to 130%, the motor goes to the nominal temperature with 130% of the motor nominal current.

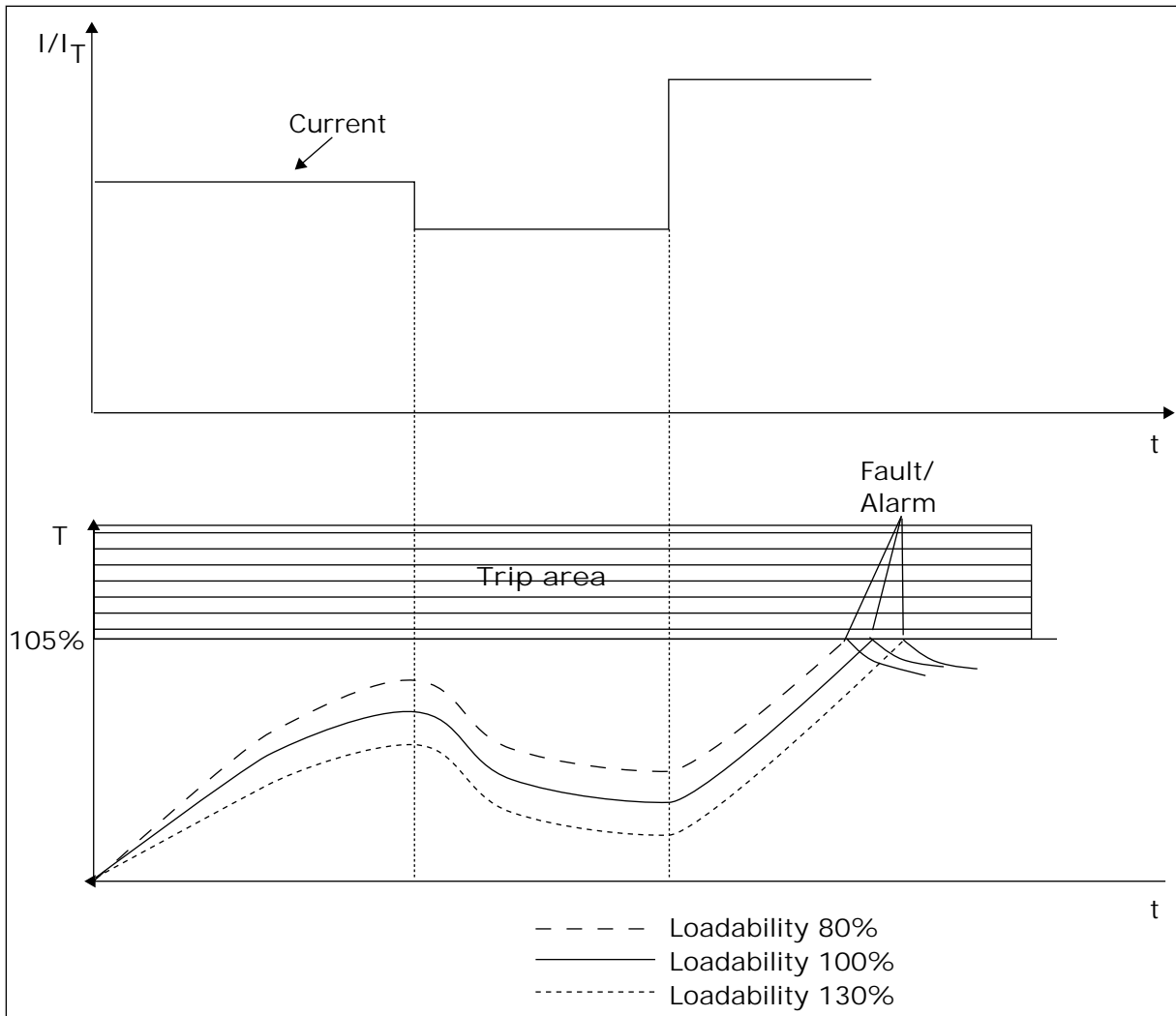

Fig. 57: The calculation of the motor temperature

9.9.2 MOTOR STALL PROTECTION

The motor stall protection function gives protection to the motor against short overloads. An overload can be caused, for example, by a stalled shaft. It is possible to set the reaction time of the stall protection shorter than that of the motor thermal protection.

The stall status of the motor is specified with parameters P3.9.3.2 Stall Current and P3.9.3.4 Stall Frequency Limit. If the current is higher than the limit, and the output frequency is lower than the limit, the motor is in a stall status.

The stall protection is a type of overcurrent protection.



NOTE!

If you use long motor cables (max. 100 m) with small drives (1.5 kW), the motor current that the drive measures can be much higher than the actual motor current. It is because there are capacitive currents in the motor cable.

P3.9.3.2 STALL CURRENT (ID 710)

You can set the value of this parameter between 0.0 and $2 \cdot I_L$. For a stall status to occur, the current must be higher than this limit. If parameter P3.1.3.1 Motor Current Limit changes, this parameter is automatically calculated to 90% of the current limit.



NOTE!

The value of the Stall Current must be below the motor current limit.

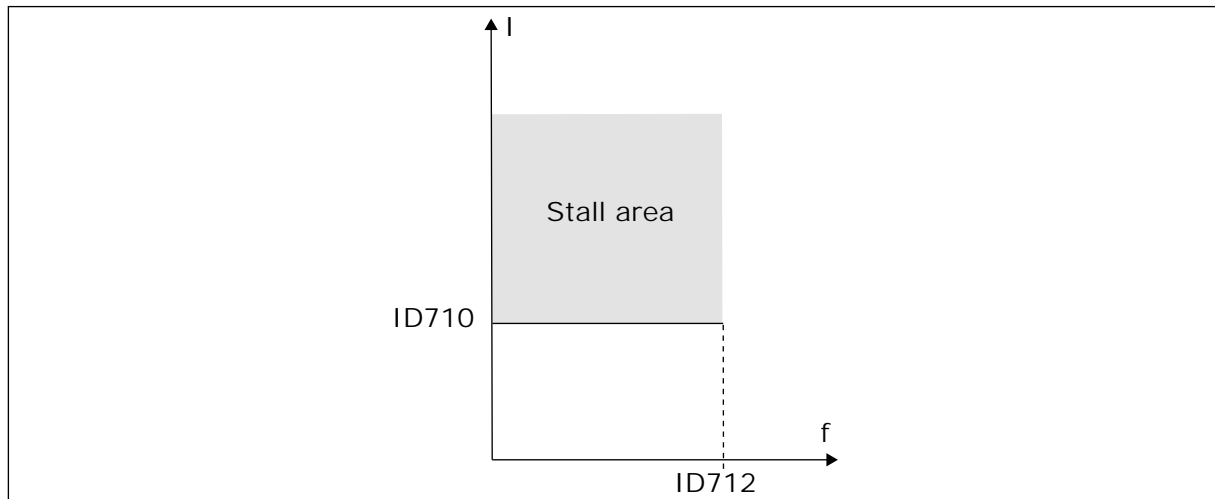

Fig. 58: The stall characteristics settings

P3.9.3.3 STALL TIME LIMIT (ID 711)

You can set the value of this parameter between 1.0 and 120.0 s. This is the maximum time for the stall status to be active. An internal counter counts the stall time.

If the stall time counter value goes above this limit, the protection causes the drive to trip.

9.9.3 UNDERLOAD PROTECTION

The motor underload protection makes sure that there is a load on the motor when the drive operates. If the motor loses the load, a problem can occur in the process. For example, a belt can break or a pump become dry.

You can adjust the motor underload protection with parameters P3.9.4.2 (Underload Protection: Field Weakening Area Load) and P3.9.4.3 (Underload Protection: Zero Frequency Load). The underload curve is a squared curve between the zero frequency and the field weakening point. The protection is not active below 5 Hz. The underload time counter does not operate below 5 Hz.

The values of the underload protection parameters are set in percentage of the nominal torque of the motor. To find the scaling ratio for the internal torque value, use the data in the name plate data of the motor, the motor nominal current and the nominal current of the drive IH. If you use another current than the nominal motor current, the precision of the calculation decreases.

**NOTE!**

If you use long motor cables (max. 100 m) with small drives (1.5 kW), the motor current that the drive measures can be much higher than the actual motor current. It is because there are capacitive currents in the motor cable.

P3.9.4.2 UNDERLOAD PROTECTION: FIELD WEAKENING AREA LOAD (ID 714)

You can set the value of this parameter between 10.0 and 150.0% x T_{nMotor} . This value is the limit for the minimum torque when the output frequency is above the field weakening point.

If you change parameter P3.1.1.4 (Motor Nominal Current), this parameter goes automatically back to its default value. See 9.9.3 *Underload protection*.

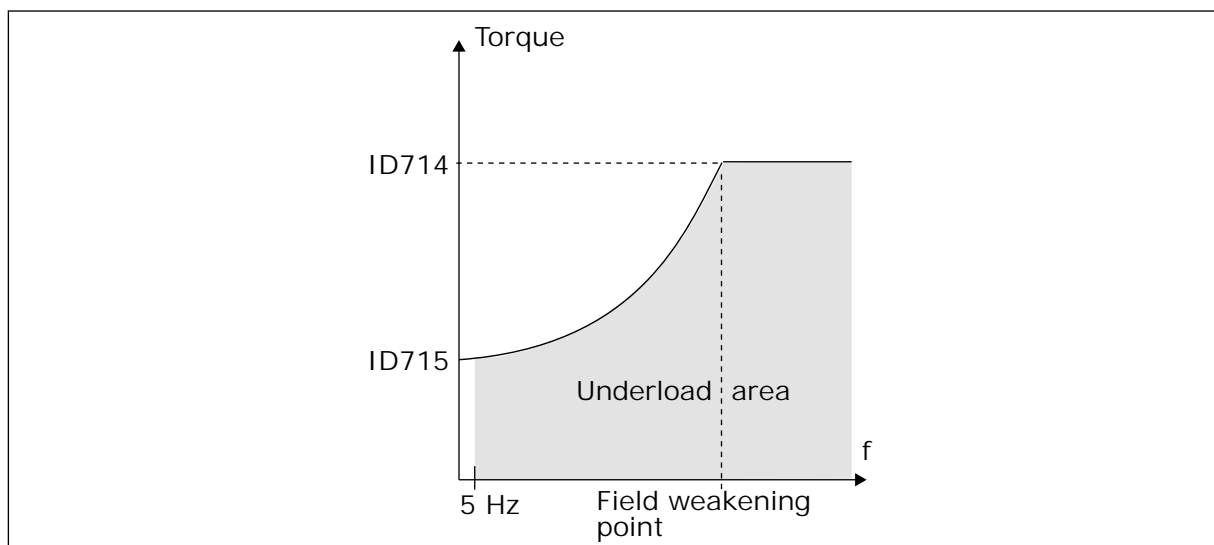

Fig. 59: Setting of the minimum load

P3.9.4.4 UNDERLOAD PROTECTION: TIME LIMIT (ID 716)

You can set the time limit between 2.0 and 600.0 s.

This is the maximum time for an underload status to be active. An internal counter counts the underload time. If the value of the counter goes above this limit, the protection causes the drive to trip. The drive trips as is set in parameter P3.9.4.1 Underload Fault. If the drive stops, the underload counter goes back to 0.

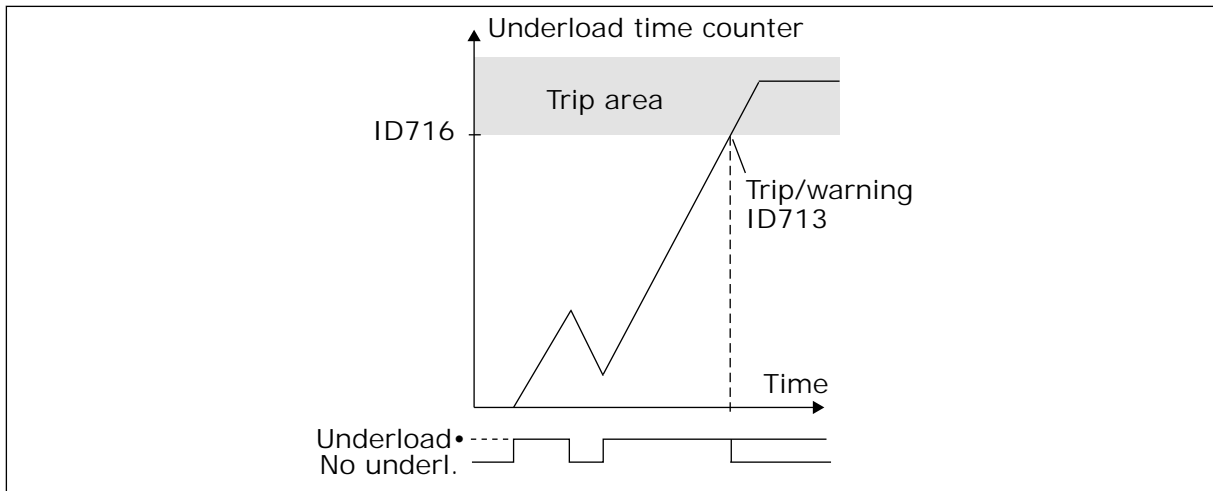

Fig. 60: The Underload time counter function

P3.9.5.1 QUICK STOP MODE (ID 1276)

P3.9.5.2 (P3.5.1.26) QUICK STOP ACTIVATION (ID 1213)

P3.9.5.3 QUICK STOP DECELERATION TIME (ID 1256)

P3.9.5.4 RESPONSE TO QUICK STOP FAULT (ID 744)

With the quick stop function, you can stop the drive in an unusual procedure from I/O or Fieldbus in unusual conditions. When the quick stop function is active, you can make the drive decelerate and stop. It is possible to program an alarm or fault to put a mark in the fault history that there was a request for a quick stop.



CAUTION!

Do not use the quick stop function as an emergency stop. An emergency stop must stop the power supply to the motor. The quick stop function does not do this.

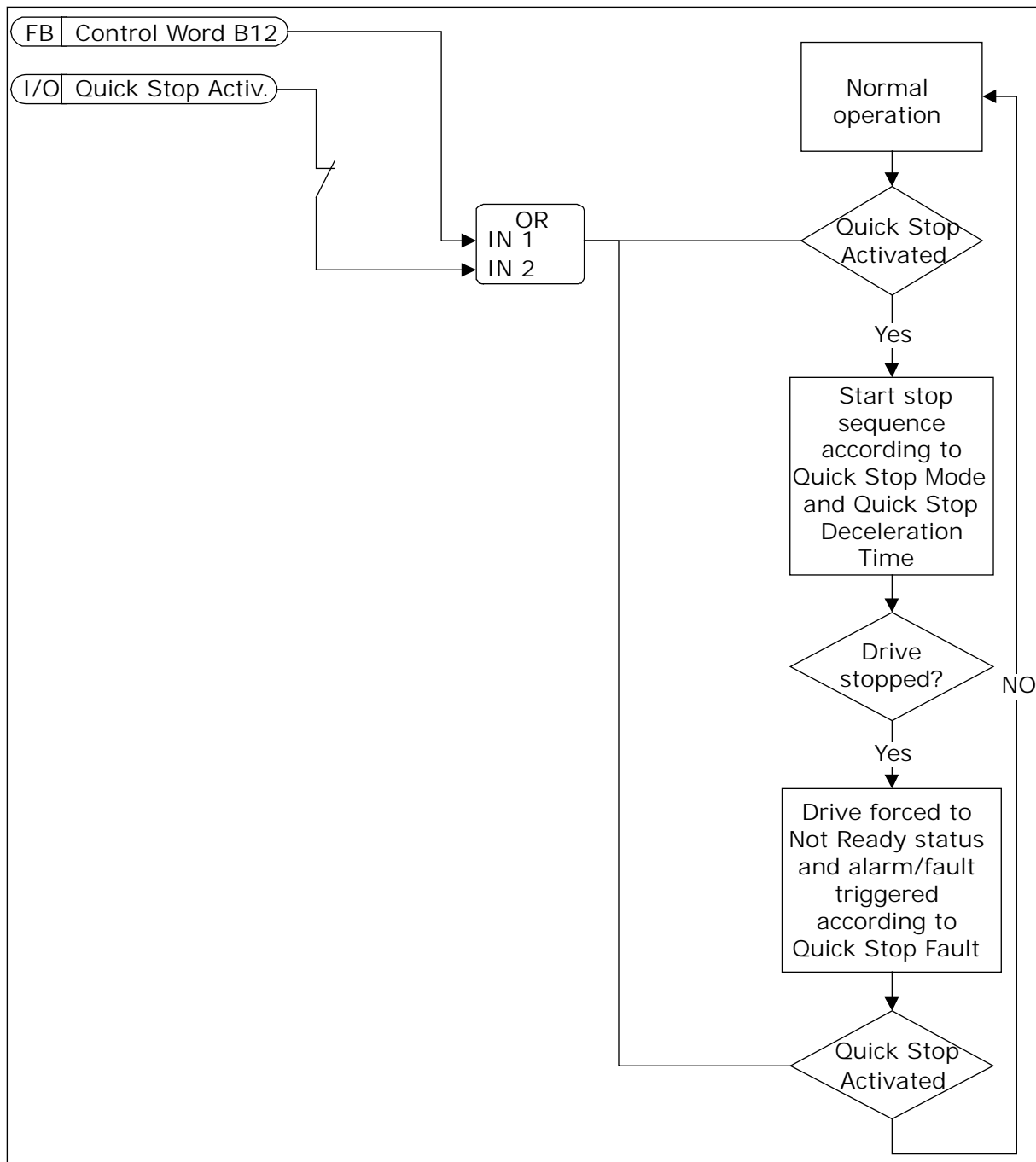

Fig. 61: The quick stop logic

P3.9.8.1 ANALOGUE INPUT LOW PROTECTION (ID 767)

Use the AI Low Protection to find failures in the analogue input signals. This function gives protection only to the analogue inputs that are used as frequency reference, torque reference, or in the PID/ExtPID controllers.

You can have the protection on when the drive is in the RUN status, or in the RUN and STOP statuses.

Selection number	Selection name	Description
1	Protection disabled	
2	Protection enabled in RUN status	The protection is enabled only when the drive is in the RUN status.
3	Protection enabled in RUN and STOP status	The protection is enabled in the 2 statuses, RUN and STOP.

P3.9.8.2 ANALOGUE INPUT LOW FAULT (ID 700)

If AI Low Protection is enabled with parameter P3.9.8.1, this parameter gives a response for the fault code 50 (Fault ID 1050).

The AI low protection function monitors the signal level of the analogue inputs 1-6. If the analogue input signal becomes less than 50% of the minimum signal for 3 s, an AI Low fault or alarm shows.



NOTE!

You can use the value *Alarm + Previous Freq* only when you use analogue input 1 or analogue input 2 as frequency reference.

Selection number	Selection name	Description
0	No Action	AI Low Protection is not used.
1	Alarm	
2	Alarm, preset frequency	The frequency reference is set as in P3.9.1.13 Preset Alarm Frequency.
3	Alarm, previous frequency	The last valid frequency is kept as frequency reference.
4	Fault	The drive stops as is set in P3.2.5 Stop Mode.
5	Fault, coasting	The drive stops by coasting.

P3.9.9.2 RESPONSE TO USER DEFINED FAULT 1 (ID 15525)

This parameter sets the response to User Defined Fault 1 (Fault ID 1114), that is, how the drive operates when the fault occurs.

P3.9.10.2 RESPONSE TO USER DEFINED FAULT 2 (ID 15526)

This parameter sets the response to User Defined Fault 2 (Fault ID 1115), that is, how the drive operates when the fault occurs.

9.10 AUTOMATIC RESET

P3.10.1 AUTOMATIC RESET (ID 731)

Use parameter P3.10.1 to enable the Automatic reset function. To make a selection of faults that are reset automatically, give the value *0* or *1* to parameters from P3.10.6 to P3.10.13.



NOTE!

The automatic reset function is available only for some fault types.

P3.10.3 WAIT TIME (ID 717)

P3.10.4 TRIAL TIME (ID 718)

Use this parameter to set the trial time for the automatic reset function. During the trial time, the automatic reset function tries to reset the faults that occur. The time count starts from the first automatic reset. The next fault starts the trial time count again.

P3.10.5 NUMBER OF TRIALS (ID 759)

If the number of trials during the trial time is more than the value of this parameter, a permanent fault shows. If not, the fault goes out of view after the trial time is completed.

With parameter P3.10.5, you can set the maximum number of automatic reset trials during the trial time set in P3.10.4. The fault type does not have an effect on the maximum number.

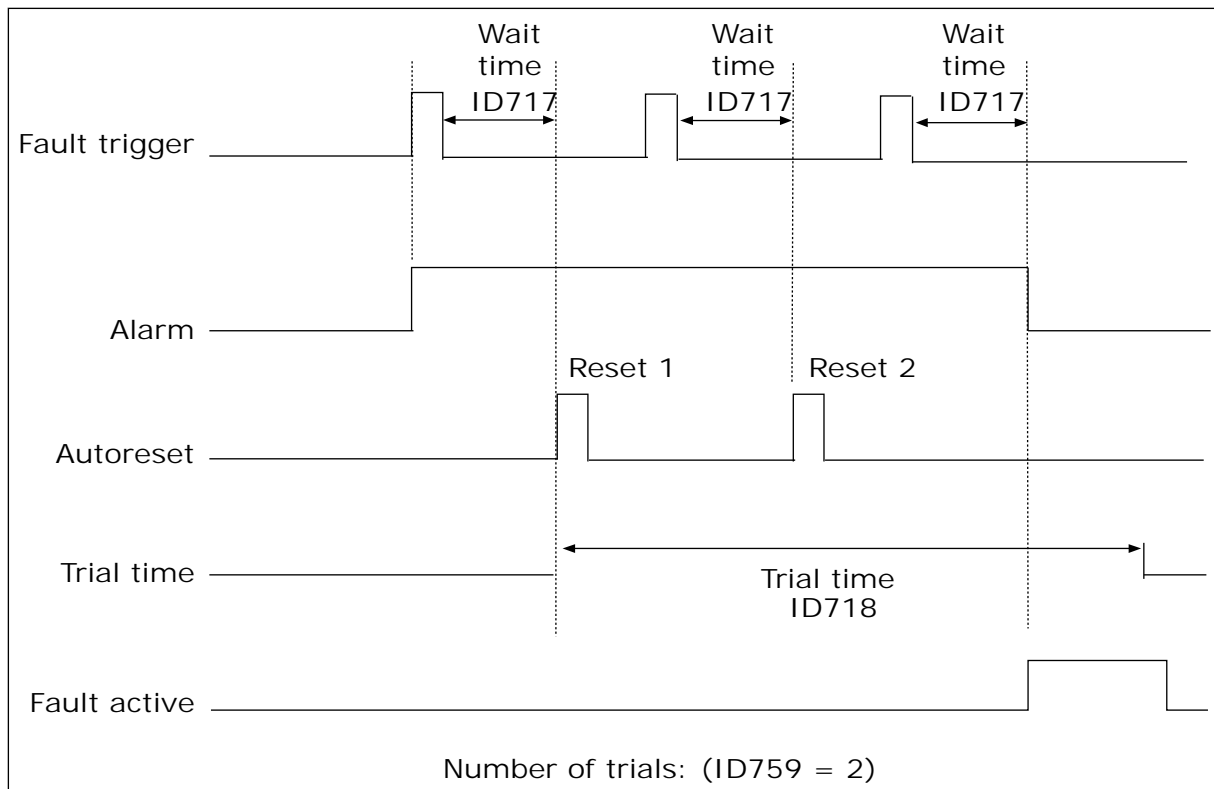

Fig. 62: The Automatic reset function

9.11 TIMER FUNCTIONS

The timer functions make it possible for the internal RTC (Real Time Clock) to control functions. All the functions that can be controlled with a digital input, can also be controlled with the RTC, with time channels 1-3. It is not necessary to have an external PLC to control a digital input. You can program the closed and opened intervals of the input internally.

To get the best results of the timer functions, install a battery, and make the settings of the Real Time Clock carefully in the Start-up wizard. The battery is available as an option.



NOTE!

We do not recommend that you use the timer functions without an auxiliary battery. The time and date settings of the drive are reset at each power down, if there is no battery for the RTC.

TIME CHANNELS

You can assign the output of the interval and/or timer functions to time channels 1-3. You can use the time channels to control on/off type functions, for example relay outputs or digital inputs. To configure the on/off logic of the time channels, assign intervals and/or timers to them. A time channel can be controlled by many different intervals or timers.

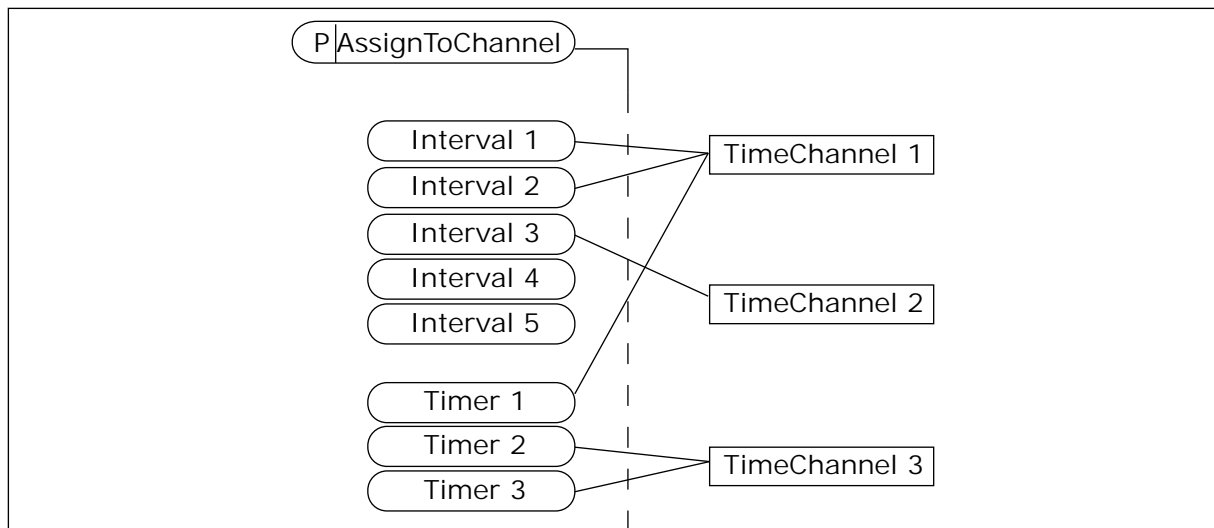

Fig. 63: Assigning intervals and timers to time channels is flexible. Every interval and timer has a parameter with which you can assign them to a time channel.

INTERVALS

Use parameters to give each interval an ON Time and OFF Time. It is the daily active time of the interval during the days set with parameters From Day and To Day. For example, with the parameter settings below, the interval is active from 7 am to 9 am from Monday to Friday. The time channel is like a digital input, but virtual.

ON Time: 07:00:00
 OFF Time: 09:00:00
 From Day: Monday
 To Day: Friday

TIMERS

Use the timers to set a time channel as active for a period with a command from a digital input or a time channel.

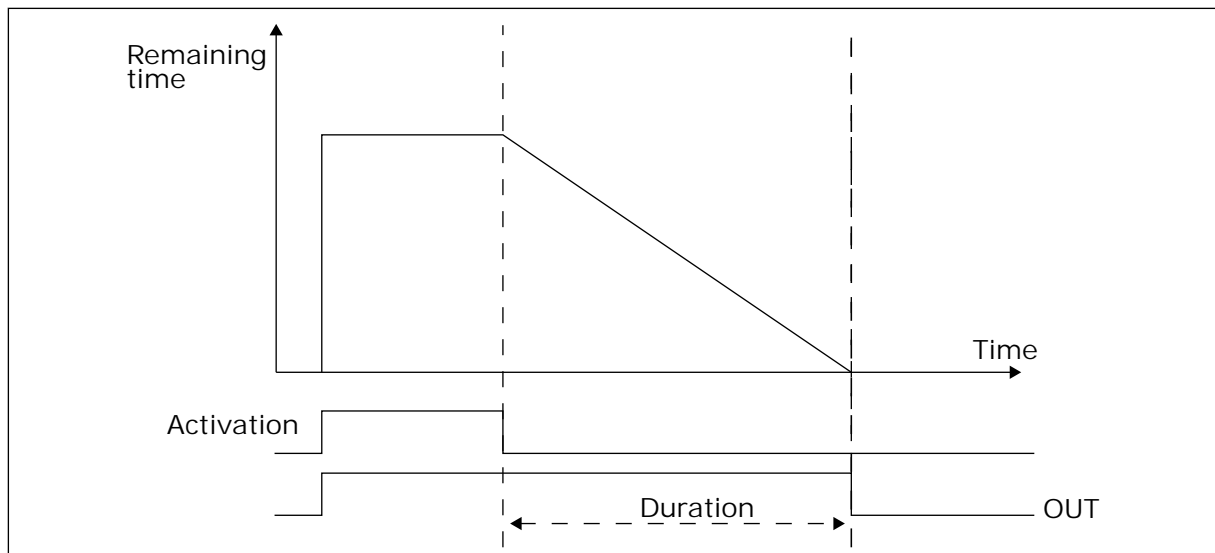

Fig. 64: The activation signal comes from a digital input or a virtual digital input, like a time channel. The timer counts down from the falling edge.

The parameters below will set the timer active when the digital input 1 on the slot A is closed. They will also keep the timer active for 30 s after it is opened.

- Duration: 30 s
- Timer: DigIn SlotA.1

You can use a duration of 0 seconds to override a time channel that is activated from a digital input. There is no off delay after the falling edge.

Example:

Problem:

The AC drive is in a warehouse and controls air conditioning. It must operate between 7 am and 5 pm on weekdays and between 9 am and 1 pm on weekends. It is also necessary for the drive to operate outside these hours, if there are personnel in the building. The drive must continue to operate 30 minutes after the personnel has left.

Solution:

Set 2 intervals, 1 for weekdays and 1 for weekends. A timer is also necessary to activate the process outside the set hours. See the configuration below.

Interval 1

P3.12.1.1: ON Time: 07:00:00

P3.12.1.2: OFF Time: 17:00:00

P3.12.1.3: Days: Monday, Tuesday, Wednesday, Thursday, Friday

P3.12.1.4: Assign to channel: Time channel 1

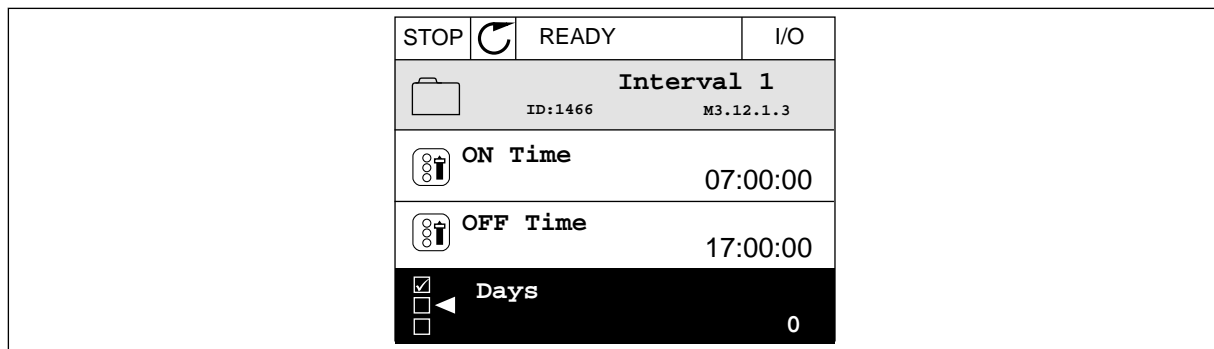

Fig. 65: Using timer functions to make an interval

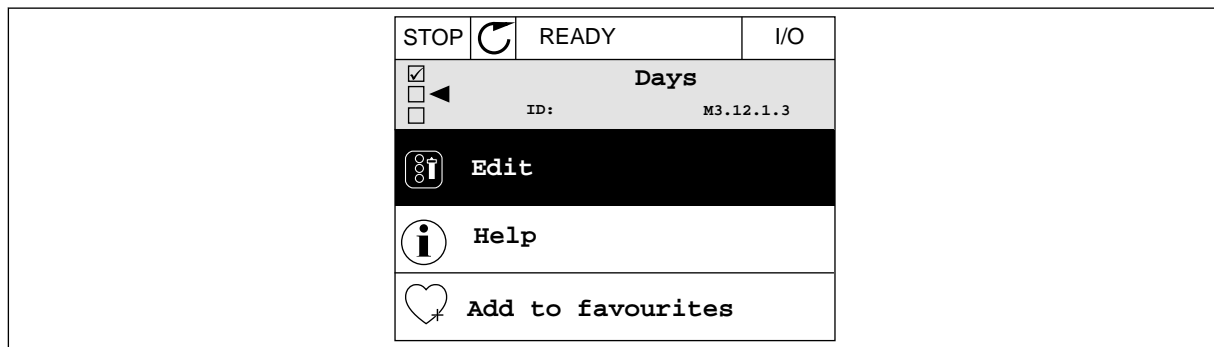

Fig. 66: Going into the Edit mode

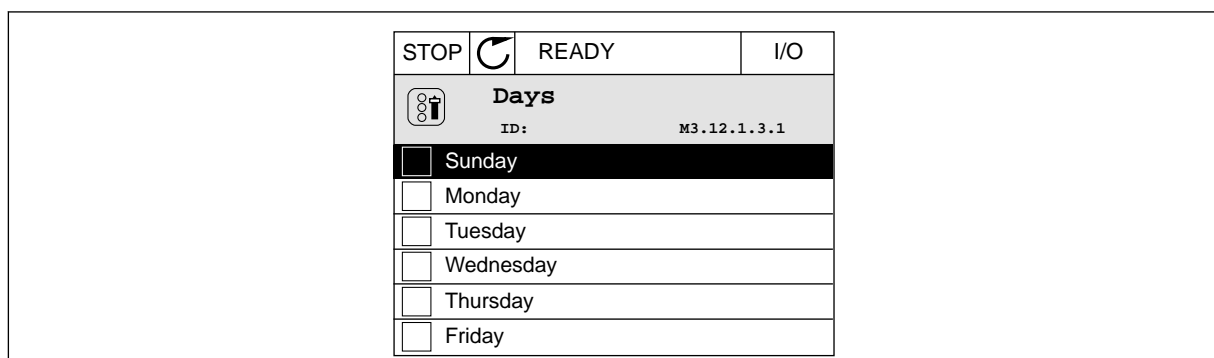

Fig. 67: The checkbox selection for the weekdays

Interval 2

P3.12.2.1: ON Time: 09:00:00

P3.12.2.2: OFF Time: 13:00:00

P3.12.2.3: Days: Saturday, Sunday

P3.12.2.4: Assign to channel: Time channel 1

Timer 1

P3.12.6.1: Duration: 1800 s (30 min)

P3.12.6.2: Timer 1: DigIn SlotA.1 (The parameter is located in the digital inputs menu.)

P3.12.6.3: Assign to channel: Time channel 1

P3.5.1.1: Control signal 1 A: Time Channel 1 for the I/O Run command

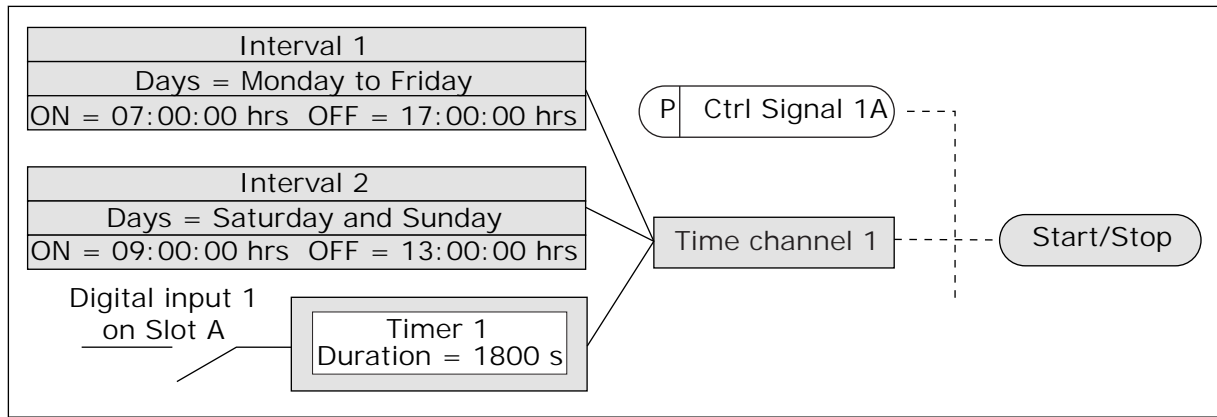

Fig. 68: Time channel 1 is used as the control signal for the start command instead of a digital input

9.12 PID CONTROLLER

P3.13.1.9 DEAD BAND (ID 1056)

P3.13.1.10 DEAD BAND DELAY (ID 1057)

If the actual value stays in the dead band area for a time set in Dead Band Delay, the PID controller output is locked. This function prevents wear and unwanted movements of the actuators, for example valves.

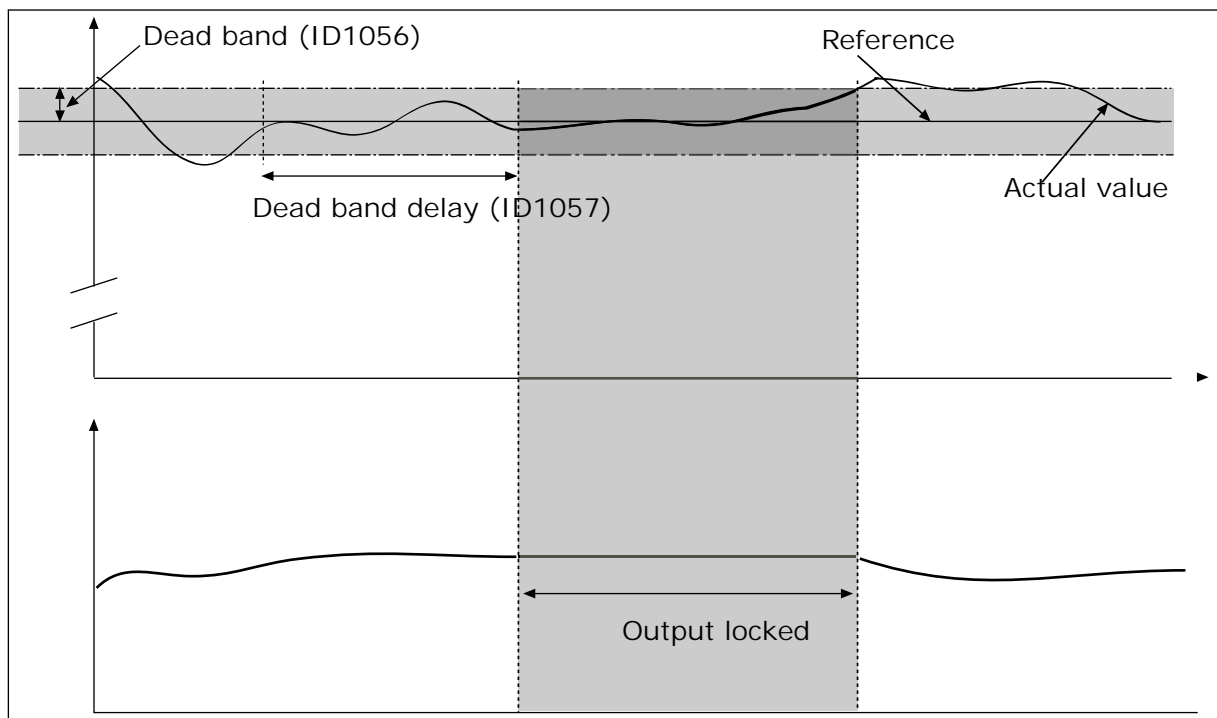

Fig. 69: The Dead band function

9.12.1 FEEDFORWARD

P3.13.4.1 FEEDFORWARD FUNCTION (ID 1059)

Accurate process models are usually necessary for the Feedforward function. In some conditions, a gain and offset type of feedforward is sufficient. The feedforward part does not use the feedback measurements of the actual controlled process value. The feedforward control uses other measurements that have an effect on the controlled process value.

EXAMPLE 1:

You can control the water level of a tank with flow control. The target water level is set as a setpoint, and the actual level as feedback. The control signal monitors the flow that comes in.

The outflow is like a disturbance that you can measure. With the measurements of the disturbance, you can try to adjust this disturbance with a feedforward control (gain and offset) that you add to the PID output. The PID controller reacts much faster to changes in the outflow than if you only measure the level.

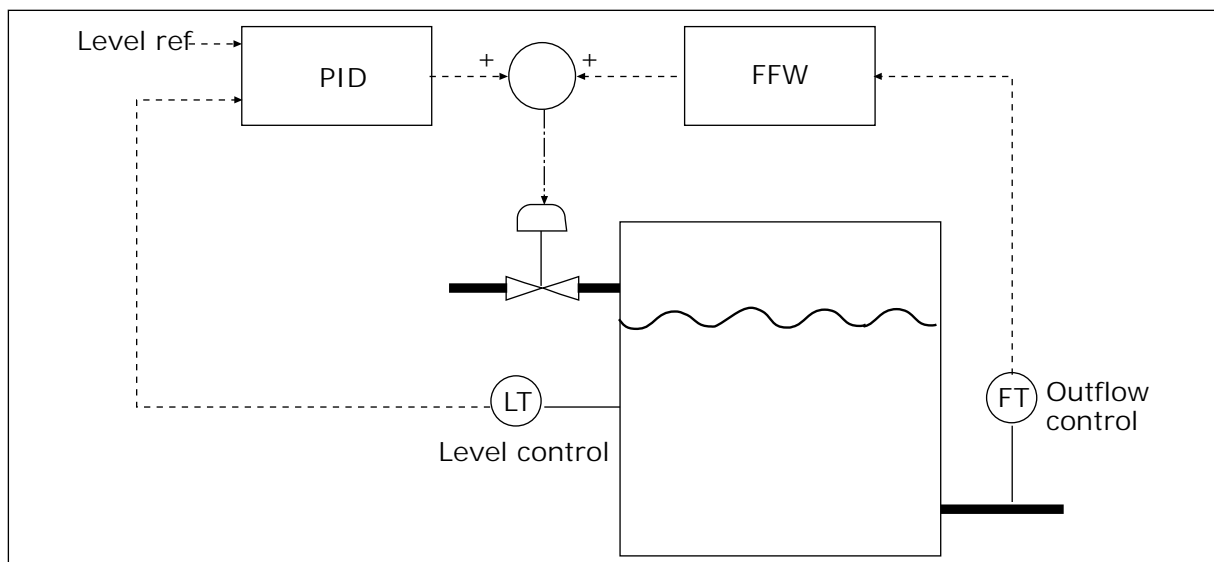

Fig. 70: The feedforward control

9.12.2 SLEEP FUNCTION

P3.13.5.1 SP1 SLEEP FREQUENCY (ID 1016)

The drive goes to sleep mode (that is, the drive stops) when the output frequency of the drive is less than the frequency limit that is set in this parameter.

The value of this parameter is used when the signal of the PID controller setpoint is taken from the setpoint source 1.

Criteria for going to sleep mode

- Output frequency remains below sleep frequency for longer than defined sleep delay time
- PID feedback signal remains above defined wake up level

Criteria for waking from sleep

- PID feedback signal falls below defined wake up level



NOTE!

A wrong set wake up level might not allow the drive to go into sleep mode

P3.13.5.2 SP1 SLEEP DELAY (ID 1017)

The drive goes to sleep mode (that is, the drive stops) when the output frequency of the drive is less than the sleep frequency limit for longer than the time that is set in this parameter.

The value of this parameter is used when the signal of the PID controller setpoint is taken from the setpoint source 1.

P3.13.5.3 SP1 WAKE-UP LEVEL (ID 1018)

P3.13.5.4 SP1 WAKE-UP MODE (ID 1019)

With these parameters, you can set when the drive wakes up from the sleep mode.

The drive wakes up from the sleep mode when the value of PID Feedback goes below the Wake-up level.

This parameter defines if Wake-up level is used as a static absolute level or as a relative level which follows PID setpoint value.

Selection 0 = Absolute level (The wake-up level is a static level that does not follow the setpoint value.)

Selection 1 = Relative setpoint (The wake-up level is an offset below the actual setpoint value. The wake-up level follows the actual setpoint.)

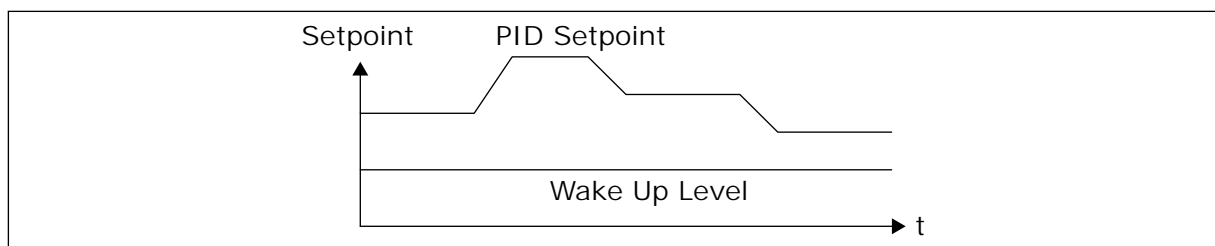

Fig. 71: Wake-up Mode: absolute level

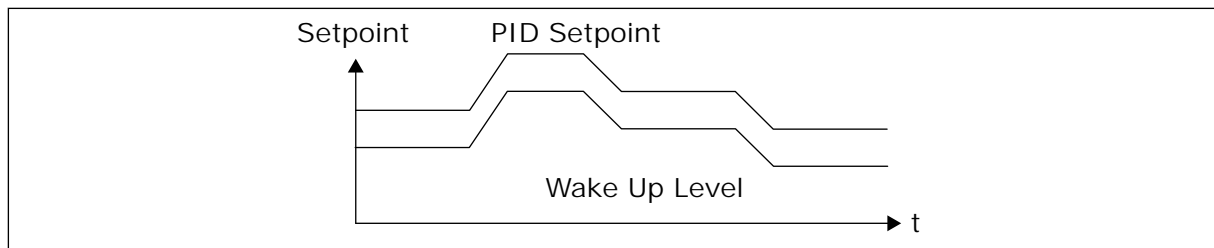

Fig. 72: Wake-up Mode: relative setpoint

P3.13.5.5 SP2 SLEEP FREQUENCY (ID 1075)

See the description of parameter P3.13.5.1.

P3.13.5.6 SP2 SLEEP DELAY (1076)

See the description of parameter P3.13.5.2.

P3.13.5.7 SP2 WAKE-UP LEVEL (ID 1077)

See the description of parameter P3.13.5.3.

P3.13.5.8 SP2 WAKE-UP MODE (ID 1020)

See the description of parameter P3.13.5.4

9.12.3 FEEDBACK SUPERVISION

Use the feedback supervision to make sure that the PID Feedback value (the process value or the actual value) stays in the set limits. With this function you can, for example, find a pipe break and stop the flooding.

These parameters set the range in which the PID Feedback signal stays in correct conditions. If the PID Feedback signal does not stay in the range, and this continues longer than the delay, a Feedback supervision fault (the fault code 101) shows.

P3.13.6.1 ENABLE FEEDBACK SUPERVISION (ID 735)

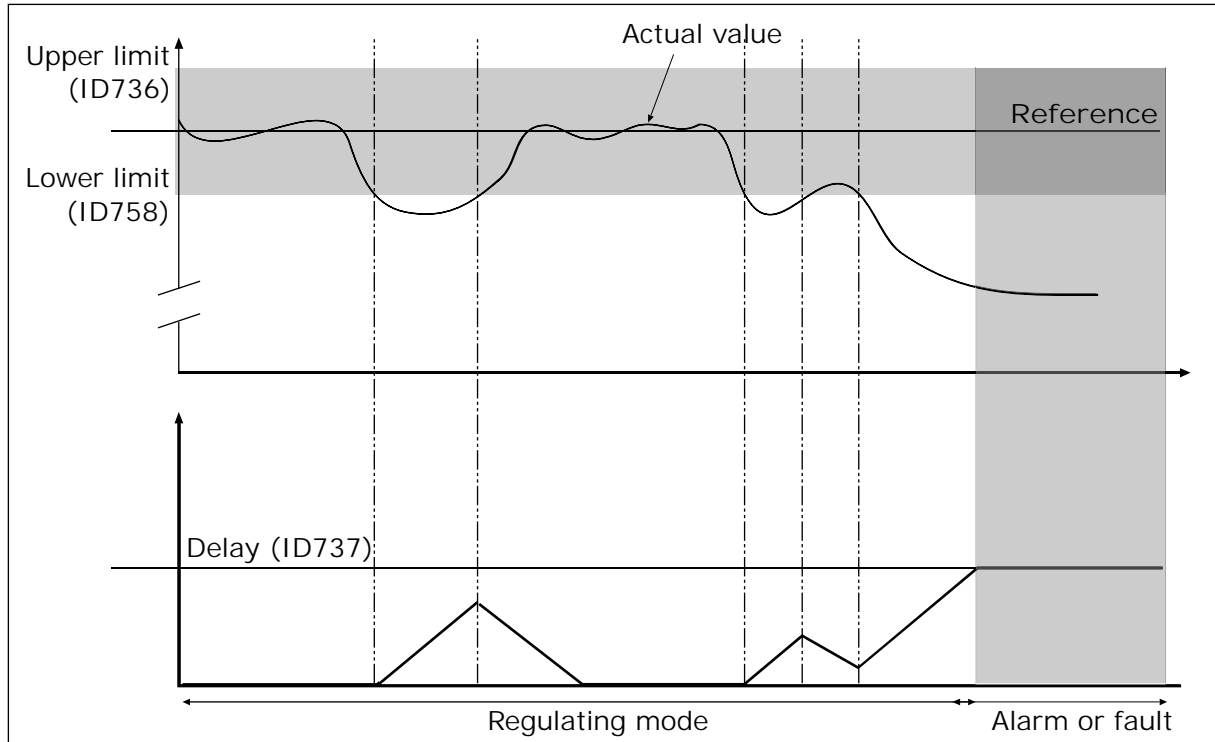

Fig. 73: The Feedback supervision function

P3.13.6.2 UPPER LIMIT (ID 736)

P3.13.6.3 LOWER LIMIT (ID 758)

Set the upper limit and the lower limit around the reference. When the actual value is less or more than the limits, a counter starts to count up. When the actual value is between the limits, the counter counts down. When the counter gets a value that is higher than the value of P3.13.6.4 Delay, an alarm or a fault shows. You can make a selection of the response with parameter P3.13.6.5 (Response to PID1 Supervision Fault).

9.12.4 PRESSURE LOSS COMPENSATION

When you pressurise a long pipe that has many outlets, the best position for the sensor is in the middle of the pipe (the position 2 in the figure). You can also put the sensor directly after the pump. This gives the right pressure directly after the pump, but farther in the pipe, the pressure drops with the flow.

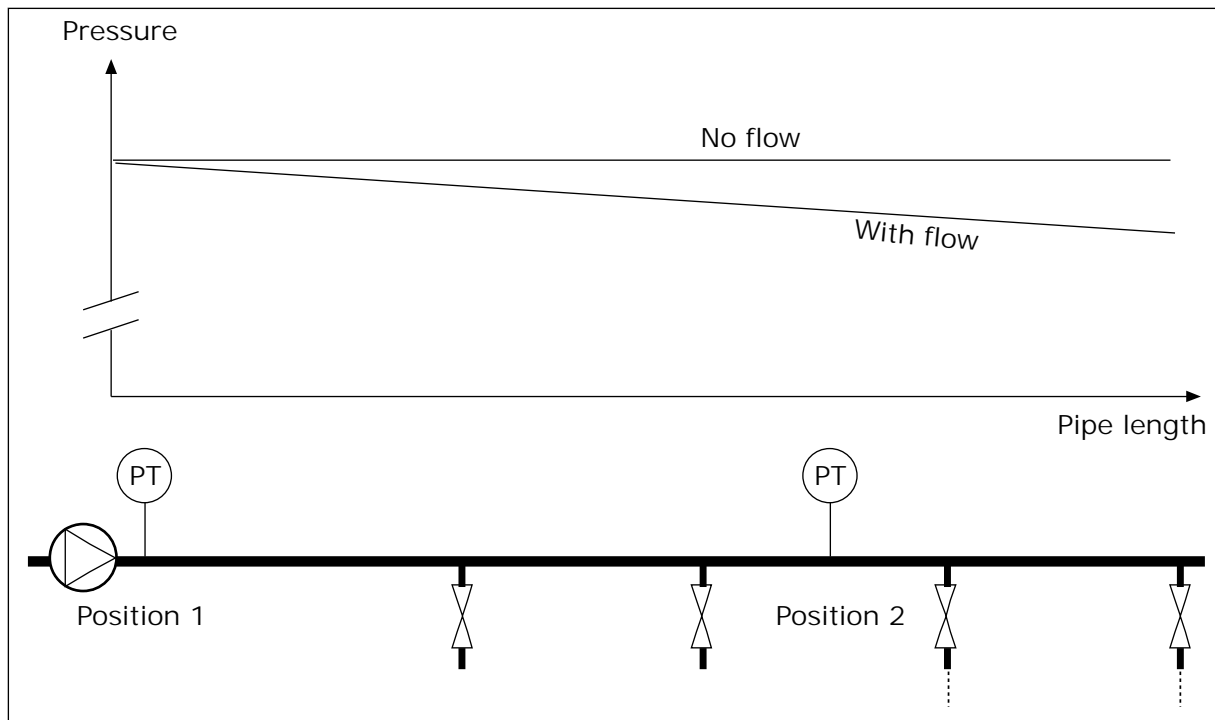

Fig. 74: The position of the pressure sensor

P3.13.7.1 ENABLE COMPENSATION FOR SETPOINT 1 (ID 1189)

P3.13.7.2 SETPOINT 1 MAX COMPENSATION (ID 1190)

The sensor is put in position 1. The pressure in the pipe stays constant when there is no flow. But with flow, the pressure decreases farther in the pipe. To compensate for this, lift the setpoint as the flow increases. Then the output frequency makes an estimate of the flow, and the setpoint increases linearly with the flow.

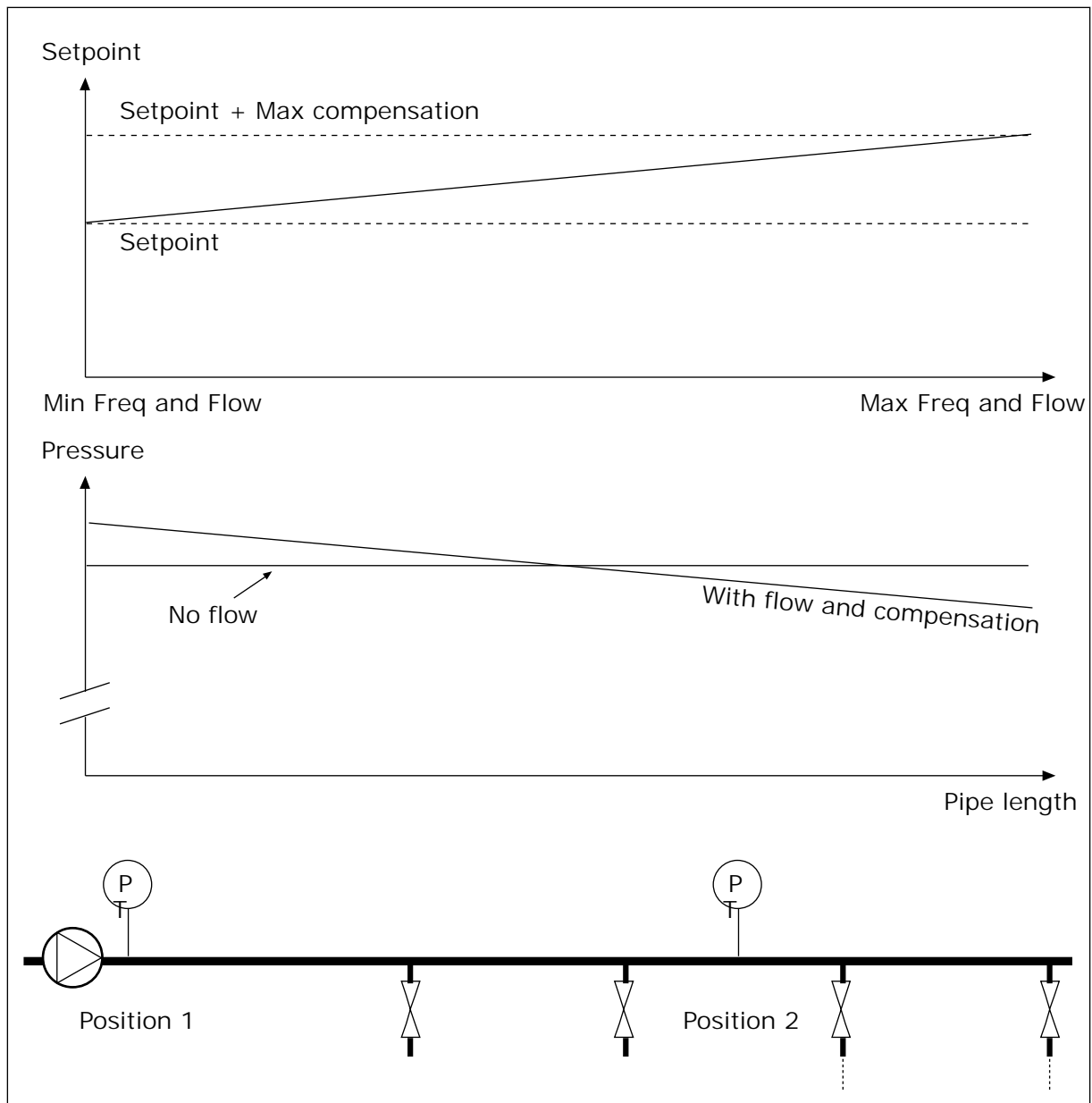

Fig. 75: Enable setpoint 1 for pressure loss compensation

9.12.5 SOFT FILL

The Soft fill function is used to move the process to a set level at a slow speed before the PID controller starts to control. If the process does not go to the set level during the timeout, a fault shows.

You can use the function to fill an empty pipe slowly and prevent strong currents of water that could break the pipe.

We recommend that you always use the Soft fill function when you use the Multipump function.

P3.13.8.1 ENABLE SOFT FILL (ID 1094)

P3.13.8.2 SOFT FILL FREQUENCY (ID 1055)

P3.13.8.3 SOFT FILL LEVEL (ID 1095)

P3.13.8.4. SOFT FILL TIMEOUT (ID 1096)

The drive operates at the soft fill frequency until the feedback value is equal with the soft fill level. If the feedback value does not become equal with the soft fill level, during the timeout, an alarm or fault shows. You can make a selection of the response with parameter P3.13.8.5 (PID Soft Fill Timeout Response).

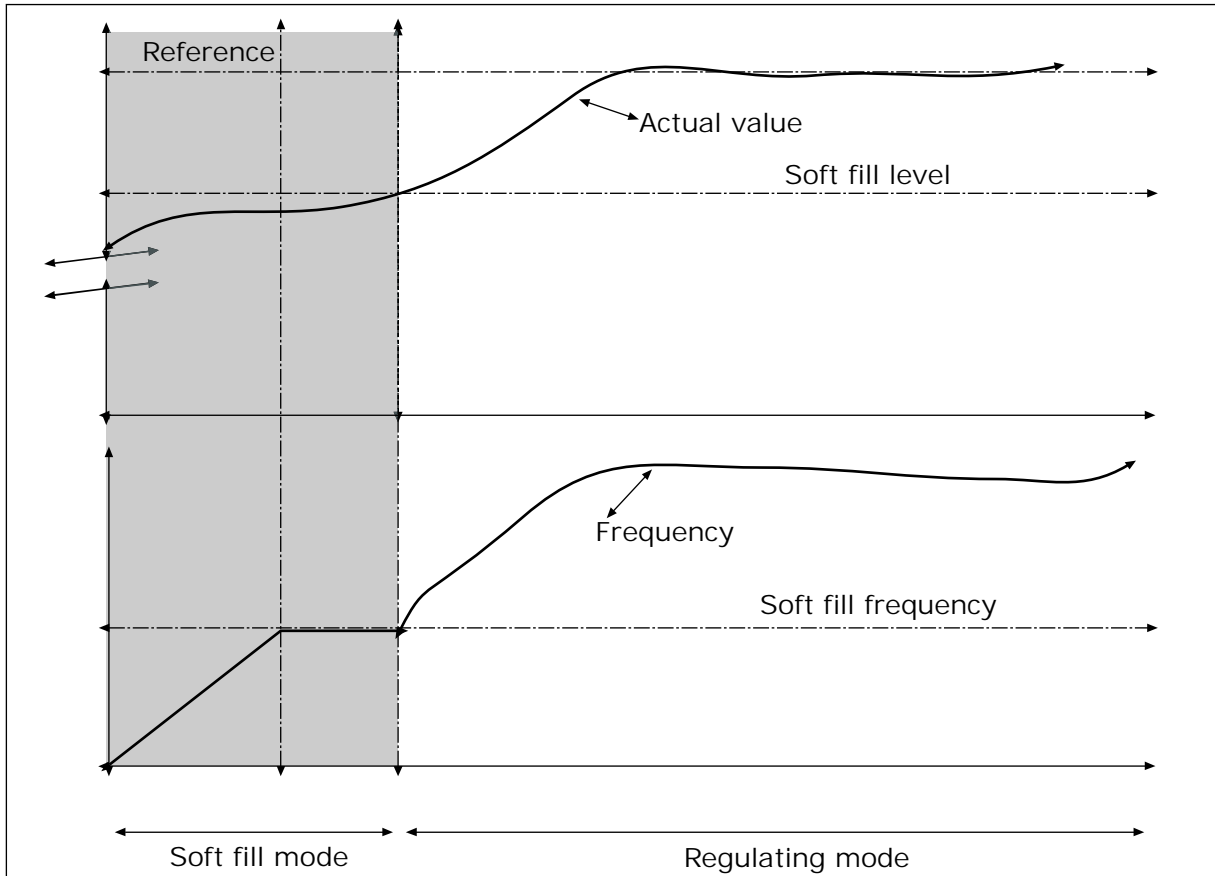

Fig. 76: The Soft fill function

9.12.6 INPUT PRESSURE SUPERVISION

Use the Input pressure supervision to make sure that there is enough water in the inlet of the pump. When there is enough water, the pump does not suck air and there is no suction cavitation. To use the function, install a pressure sensor on the pump inlet.

If the input pressure of the pump goes below the set alarm limit, an alarm shows. The setpoint value of the PID controller decreases and causes the output pressure of the pump to decrease. If the pressure goes below the fault limit, the pump is stops and a fault shows.

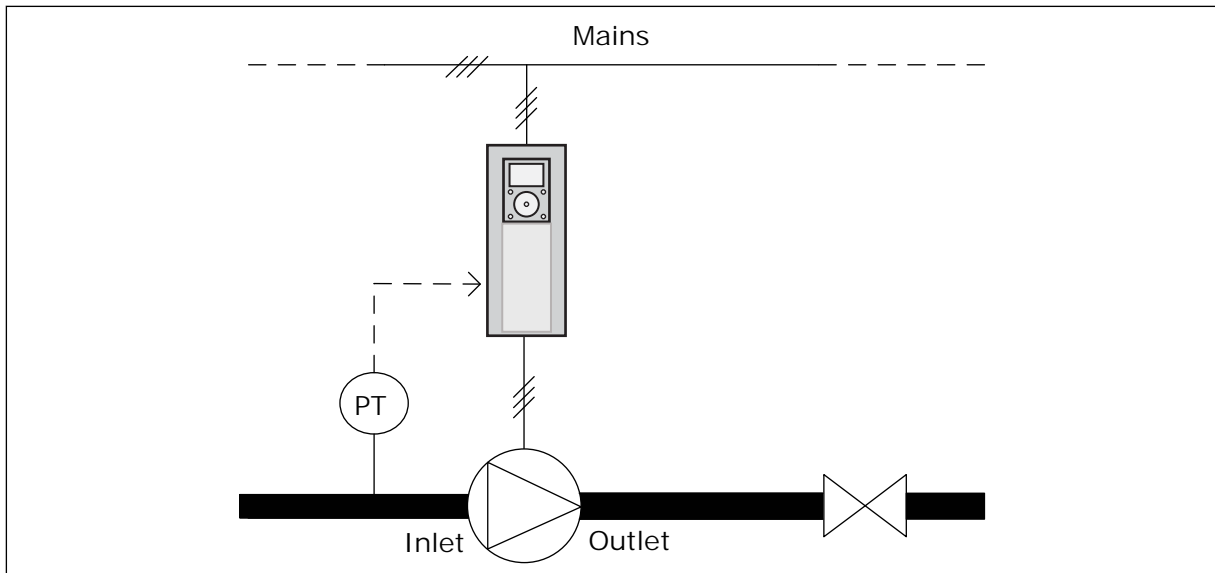

Fig. 77: The location of the pressure sensor

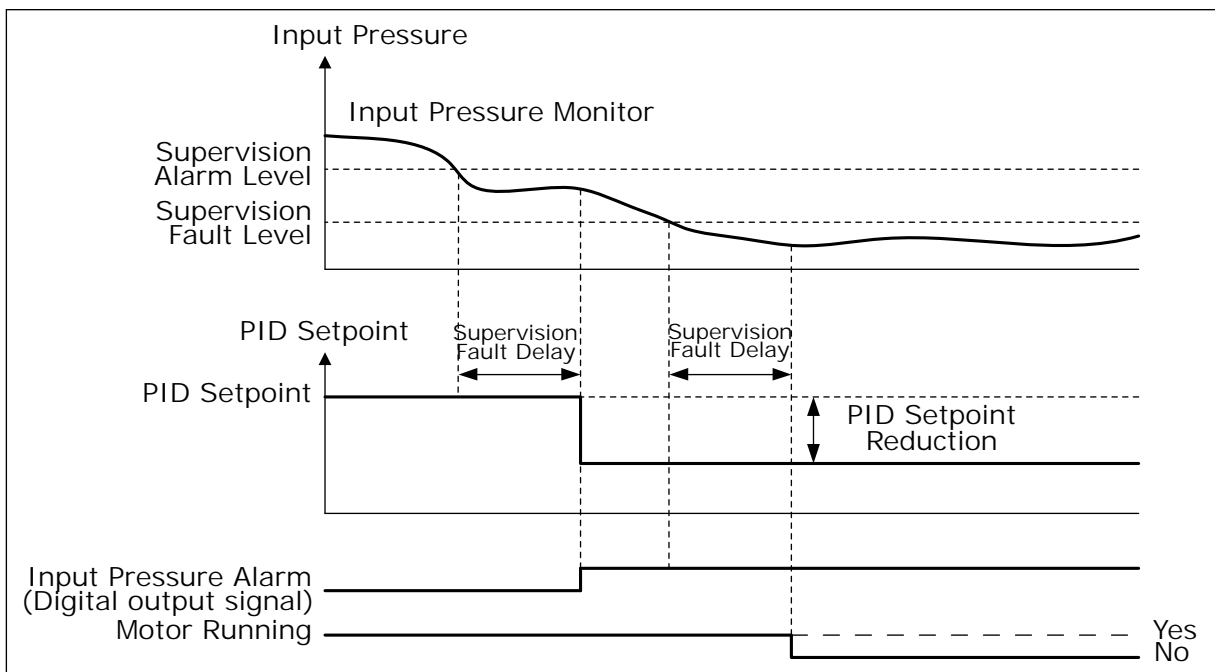

Fig. 78: The Input pressure supervision function

9.12.7 FROST PROTECTION

Use the Frost protection function to protect the pump from frost damages. If the pump is in sleep mode and the temperature that is measured in the pump goes below the set protection temperature, operate the pump at a constant frequency (that is set in P3.13.10.6 Frost Protection Frequency). To use the function, you must install a temperature transducer or a temperature sensor on the pump covering or on the pipe line near the pump.

9.13 MULTIPUMP FUNCTION

The Multi-pump function lets you control a maximum of 6 motors, pumps or fans with the PID controller.

The AC drive is connected to a motor, which is the regulating motor. The regulating motor connects and disconnects the other motors to/from the mains with relays. This is done to keep the right setpoint. The Autochange function controls the sequence in which the motors start to make sure that they wear equally. You can include the regulating motor in the autochange and interlock logic, or set it to always be Motor 1. It is possible to remove motors momentarily with the Interlock function, for example for maintenance.

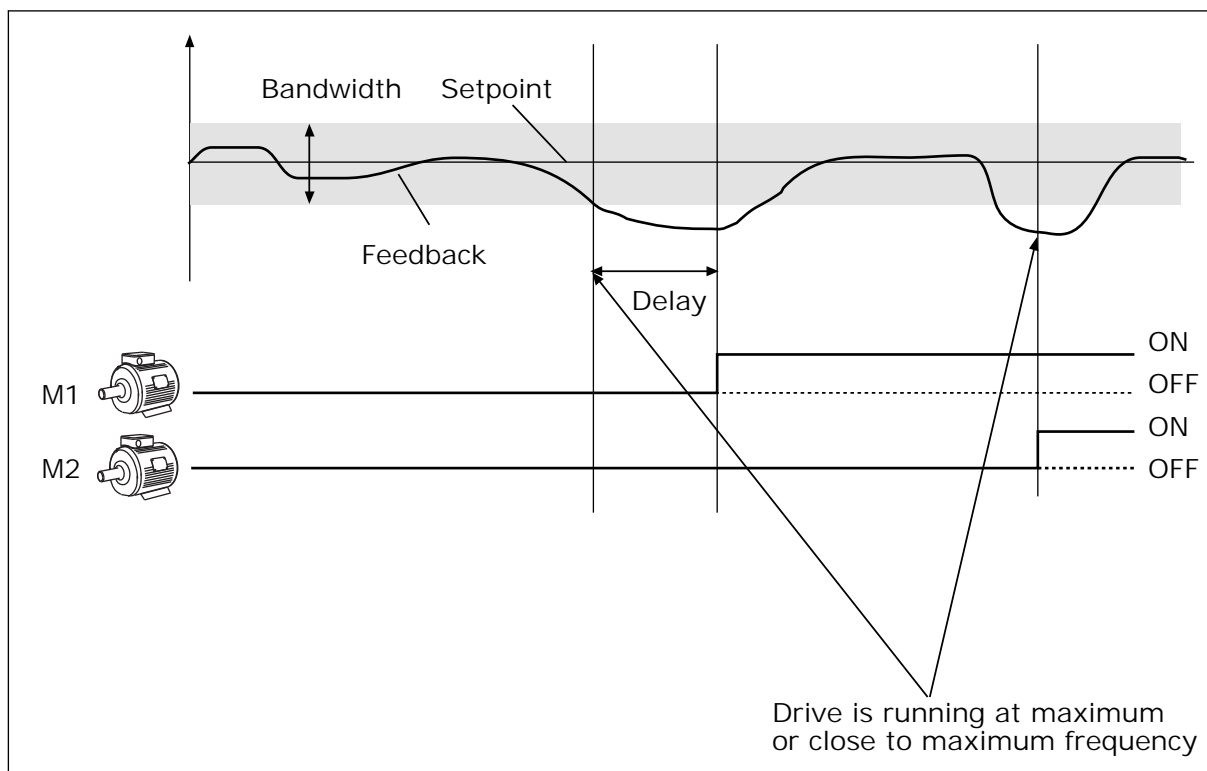

Fig. 79: The Multipump function

If the PID controller cannot keep the feedback in the set bandwidth, a motor or motors are connected or disconnected.

When to connect and/or add motors:

- The feedback value is not in the bandwidth area.
- The regulating motor operates at a close to maximum frequency (-2 Hz).
- The conditions above are true for longer than the bandwidth delay.
- There are more motors available

When to disconnect and/or remove motors:

- The feedback value is not in the bandwidth area.
- The regulating motor operates at a close to minimum frequency (+2 Hz).
- The conditions above are true for longer than the bandwidth delay.
- There are more motors that operate than the regulating one.

P3.15.2 INTERLOCK FUNCTION (ID 1032)

The interlocks tell the Multipump system that a motor is not available. This can occur when the motor is removed from the system for maintenance or bypassed for manual control.

To use the interlocks, enable the parameter P3.15.2. Make a selection of the status for each motor with a digital input (the parameters from P3.5.1.34 to P3.5.1.39). If the value of the input is CLOSED, that is, active, the motor is available for the Multipump system. If not, the Multipump logic will not connect it.

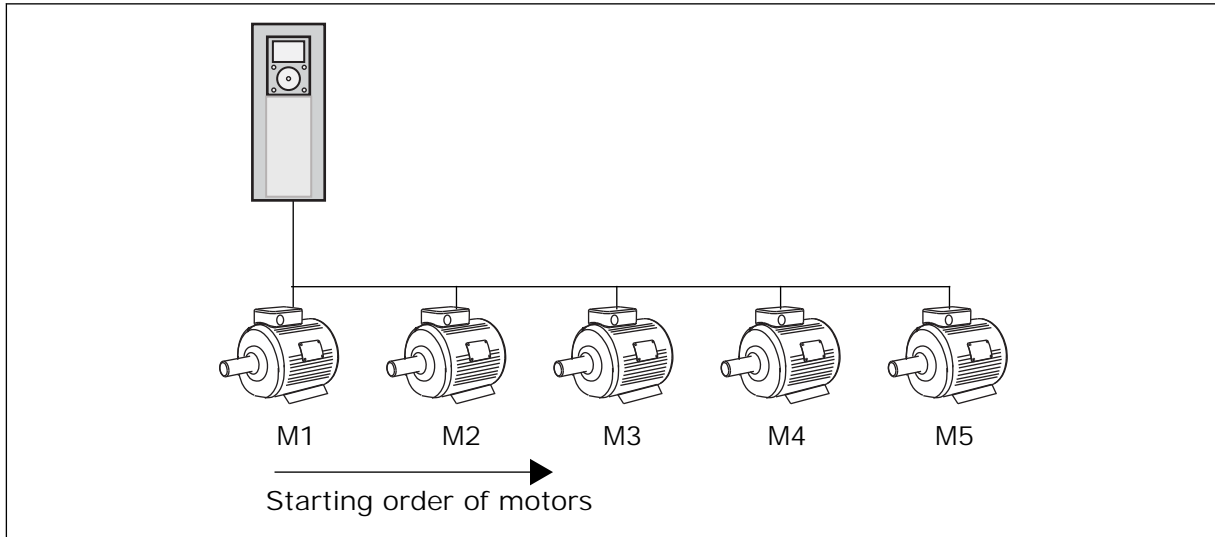

Fig. 80: The interlock logic 1

The sequence of the motors is 1, 2, 3, 4, 5.

If you remove the interlock of Motor 3, that is, you set the value of P3.5.1.36 is set to OPEN, the sequence changes to 1, 2, 4, 5.

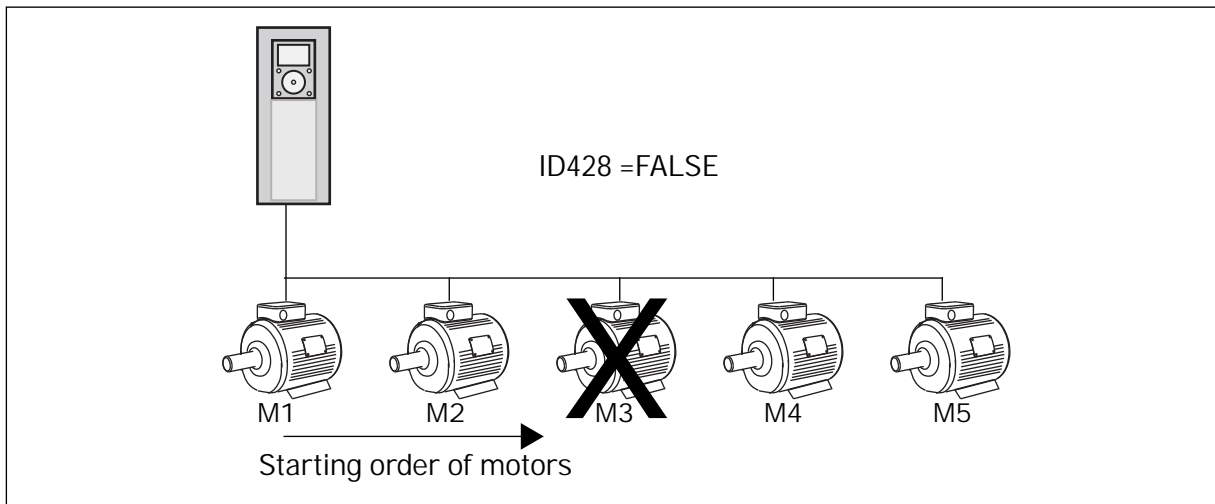

Fig. 81: The interlock logic 2

If you add Motor 3 again (you set the value of P3.5.1.36 to CLOSED), the system puts Motor 3 last in the sequence: 1, 2, 4, 5, 3. The system does not stop, but continues to operate.

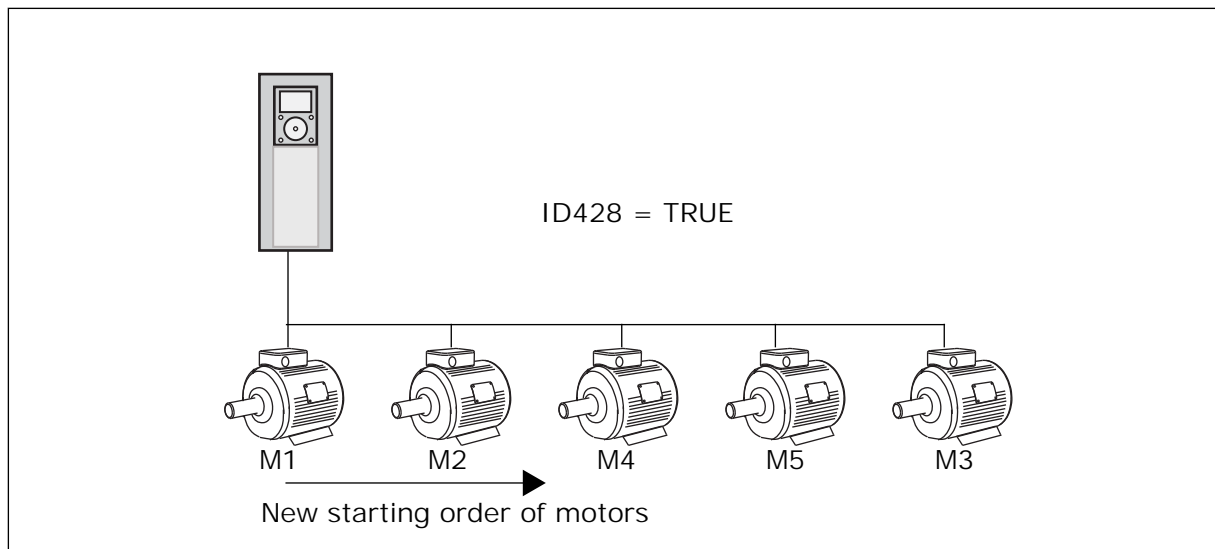

Fig. 82: The interlock logic 3

When the system stops or goes to sleep mode for the next time, the sequence changes back to 1, 2, 3, 4, 5.

P3.15.3 INCLUDE FC (ID 1028)

Selection number	Selection name	Description
0	Disabled	The drive is always connected to Motor 1. The interlocks do not have an effect on Motor 1. Motor 1 is not included in the autochange logic.
1	Enabled	It is possible to connect the drive to any of the motors in the system. The interlocks have an effect on all the motors. All the motors are included in the autochange logic.

WIRING

The connections are different for the parameter values 0 and 1.

SELECTION 0, DISABLED

The drive is directly connected to Motor 1. The other motors are auxiliary motors. They are connected to the mains by contactors, and controlled by relays of the drive. The autochange or the interlock logic do not have an effect on Motor 1.

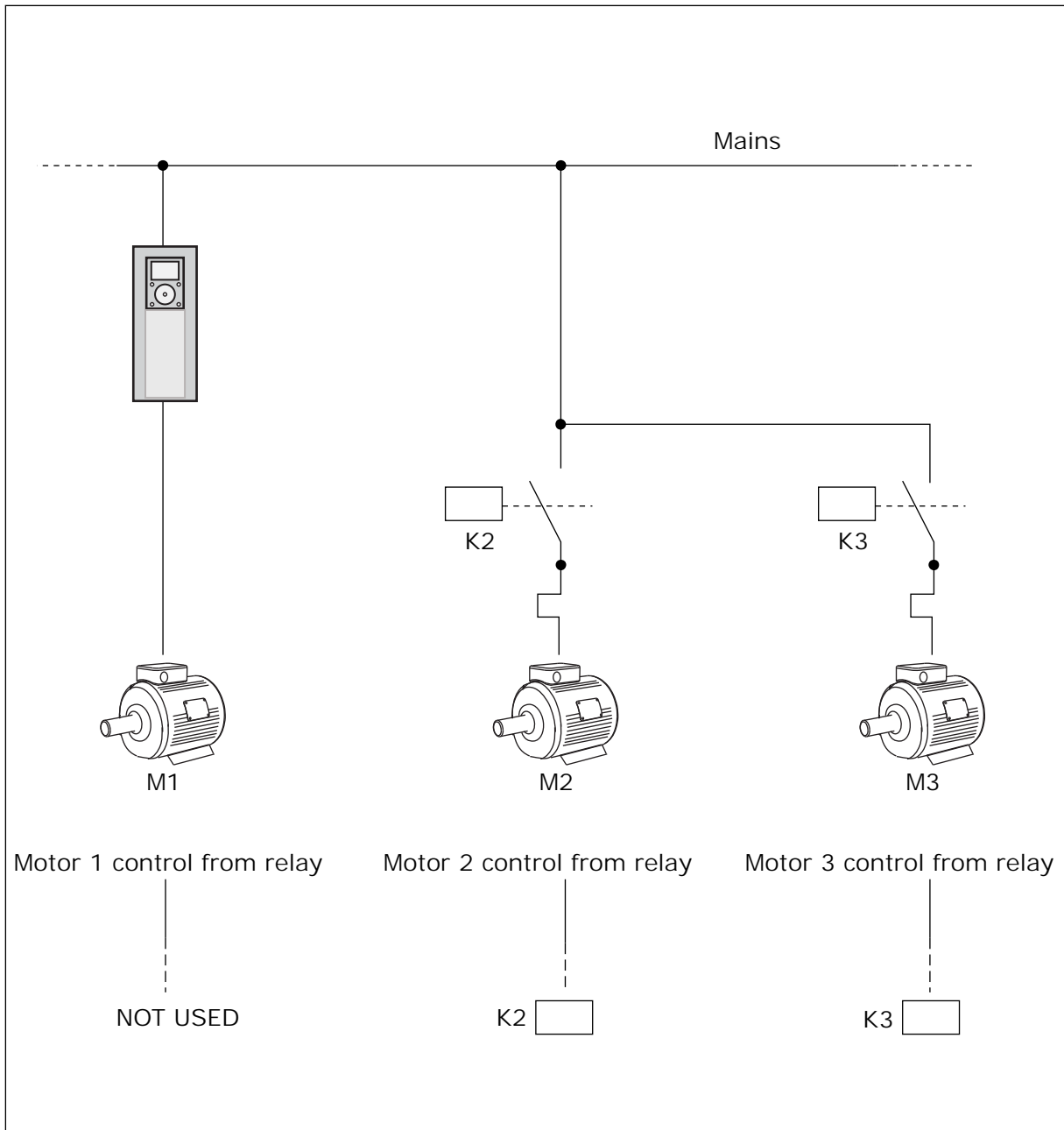

Fig. 83: Selection 0

SELECTION 1, ENABLED

To include the regulating motor in the autochange or in the interlock logic, obey the instructions in the figure below. 1 relay controls each motor. The contactor logic always connects the first motor to the drive, and the next motors to the mains.

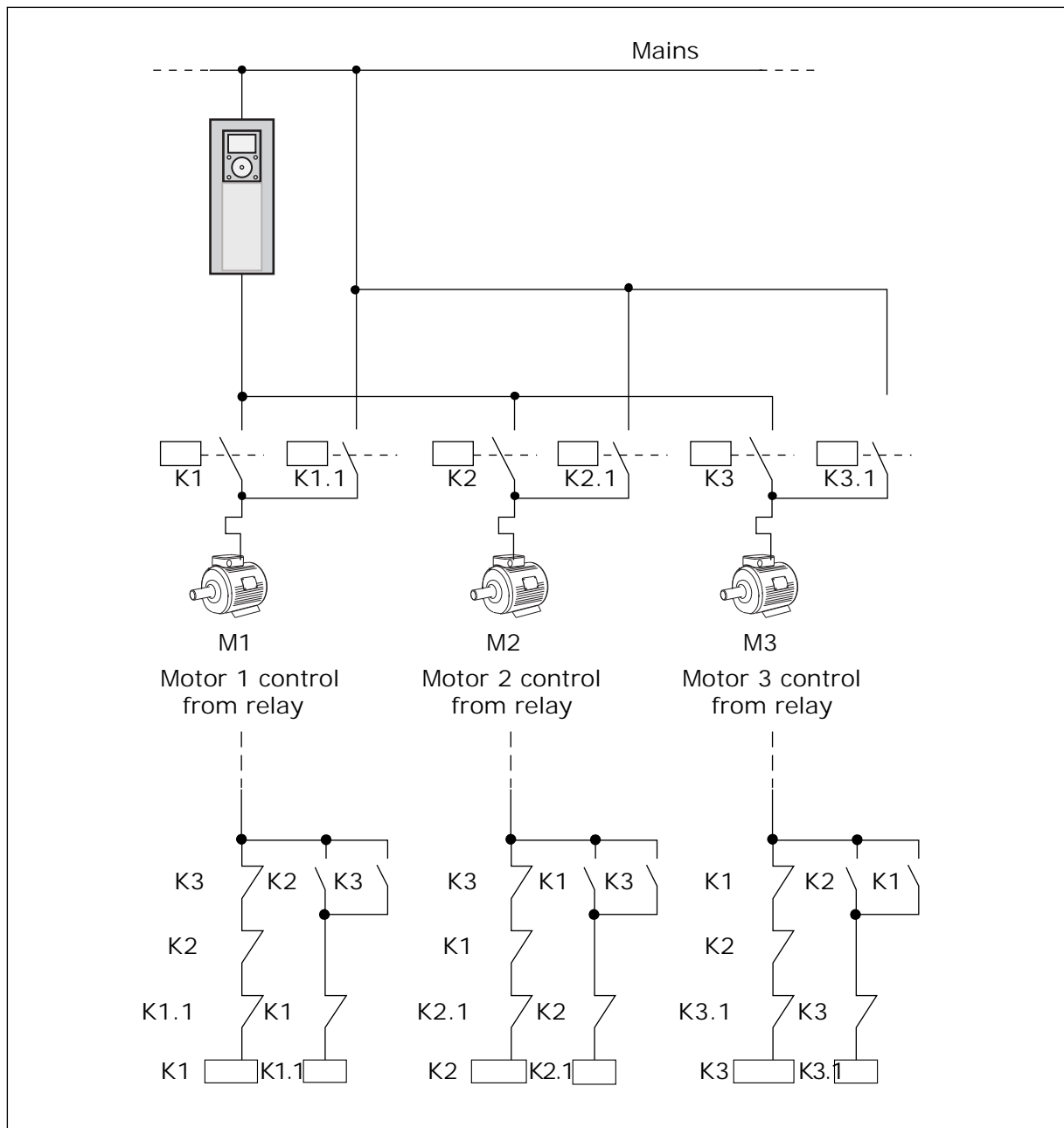

Fig. 84: Selection 1

P3.15.4 AUTOCHANGE (ID 1027)

Selection number	Selection name	Description
0	Disabled	In normal operation, the sequence of the motors is always 1, 2, 3, 4, 5. The sequence can change during the operation if you add or remove interlocks. After the drive stops, the sequence always changes back.
1	Enabled	The system changes the sequence at intervals to wear the motors equally. You can adjust the intervals of the autochange.

To adjust the intervals of the autochange, use P3.15.5 Autochange Interval. You can set the maximum number of motors that can operate with parameter Autochange: Motor Limit (P3.15.7). You can also set the maximum frequency of the regulating motor (Autochange: Frequency Limit P3.15.6).

When the process is in the limits that are set with parameters P3.15.6 and P3.15.7, the autochange occurs. If process is not in these limits, the system will wait until the process is in the limits, and do the autochange after that. This prevents sudden pressure drops during the autochange when a high capacity at a pump station is necessary.

EXAMPLE

After an autochange, the first motor is put last. The other motors move up 1 position.

The start sequence of the motors: 1, 2, 3, 4, 5

--> Autochange -->

The start sequence of the motors: 2, 3, 4, 5, 1

--> Autochange -->

The start sequence of the motors: 3, 4, 5, 1, 2

P3.15.16.1 ENABLE OVERPRESSURE SUPERVISION (ID 1698)

You can use the Overpressure supervision function in a Multipump system. For example, when you close the primary valve of the pump system quickly, the pressure in the pipe lines increases. The pressure can increase too quickly for the PID controller. To prevent that the pipes break, the overpressure supervision stops the auxiliary motors in the Multipump system.

The overpressure supervision monitors the feedback signal of the PID controller, that is, the pressure. If the signal becomes higher than the overpressure level, it stops all the auxiliary pumps immediately. Only the regulating motor continues to operate. When the pressure decreases, the system continues to operate, and connects the auxiliary motors again one at a time.

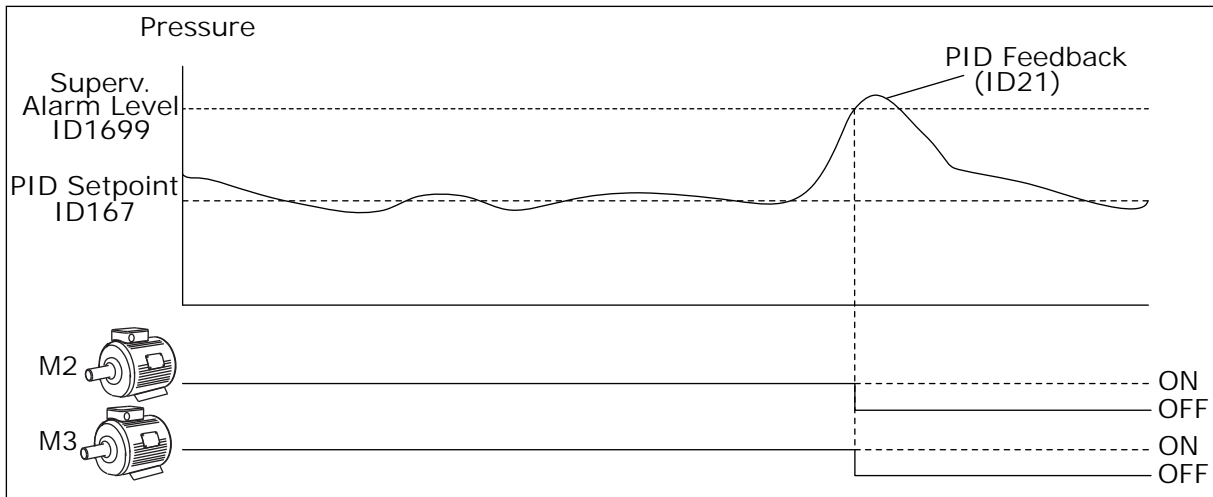

Fig. 85: The Overpressure supervision function

9.14 MAINTENANCE COUNTERS

A maintenance counter tells you that maintenance must be done. For example, it is necessary to replace a belt or to replace the oil in a gearbox. There are 2 different modes for the maintenance counters, hours or revolutions*1000. The value of the counters increases only during the RUN status of the drive.



WARNING!

Do not do maintenance if you are not approved to do it. Only an approved electrician can do maintenance. There is a risk of injury.



NOTE!

The revolutions mode uses motor speed, which is only an estimate. The drive measures the speed every second.

When the value of a counter is more than its limit, an alarm or a fault shows. You can connect the alarm and fault signals to a digital output or a relay output.

When the maintenance is completed, reset the counter with a digital input or parameter P3.16.4 Counter 1 Reset.

9.15 FIRE MODE

When Fire mode is active, the drive resets all faults that occur and continues to operate at the same speed until it is not possible. The drive ignores all commands from the keypad, fieldbuses, and the PC tool. It only obeys the signals Fire Mode Activation, Fire Mode Reverse, Run Enable, Run Interlock 1, and Run Interlock 2 from I/O.

The Fire mode function has 2 modes, the Test mode and the Enabled mode. To make a selection of a mode, write a password in parameter P3.17.1 (Fire Mode Password). In the Test mode, the drive does not automatically reset the faults, and the drive stops when a fault occurs.

It is also possible to configure Fire mode with the Fire mode wizard, which you can activate in the Quick Setup menu with parameter B1.1.4.

When you activate the Fire mode function, an alarm shows on the display.



CAUTION!

The warranty is void if the Fire mode function is activated! You can use Test mode to test the Fire mode function and the warranty stays valid.

P3.17.1 FIRE MODE PASSWORD (ID 1599)

Use this parameter to make a selection of the mode of the Fire mode function.

Selection number	Selection name	Description
1002	Enabled mode	The drive resets all the faults and continues to operate at the same speed until it is not possible
1234	Test mode	The drive does not automatically reset the faults, and the drive stops when a fault occurs.

P3.17.3 FIRE MODE FREQUENCY (ID 1598)

With this parameter, you can set the frequency reference that is used when Fire mode is active. The drive uses this frequency when the value of parameter P3.17.2 Fire Mode Frequency Source is *Fire Mode Frequency*.

P3.17.4 FIRE MODE ACTIVATION ON OPEN (ID 1596)

If this digital input signal is activated, an alarm shows on the display, and the warranty becomes void. The type of this digital input signal is NC (normally closed).

It is possible to try the Fire mode with the password that activates the Test mode. Then the warranty stays valid.



NOTE!

If Fire mode is enabled, and you give the correct password to the parameter Fire Mode Password, all the Fire mode parameters become locked. To change the Fire mode parameters, change the value of P3.17.1 Fire Mode Password to 0 first.

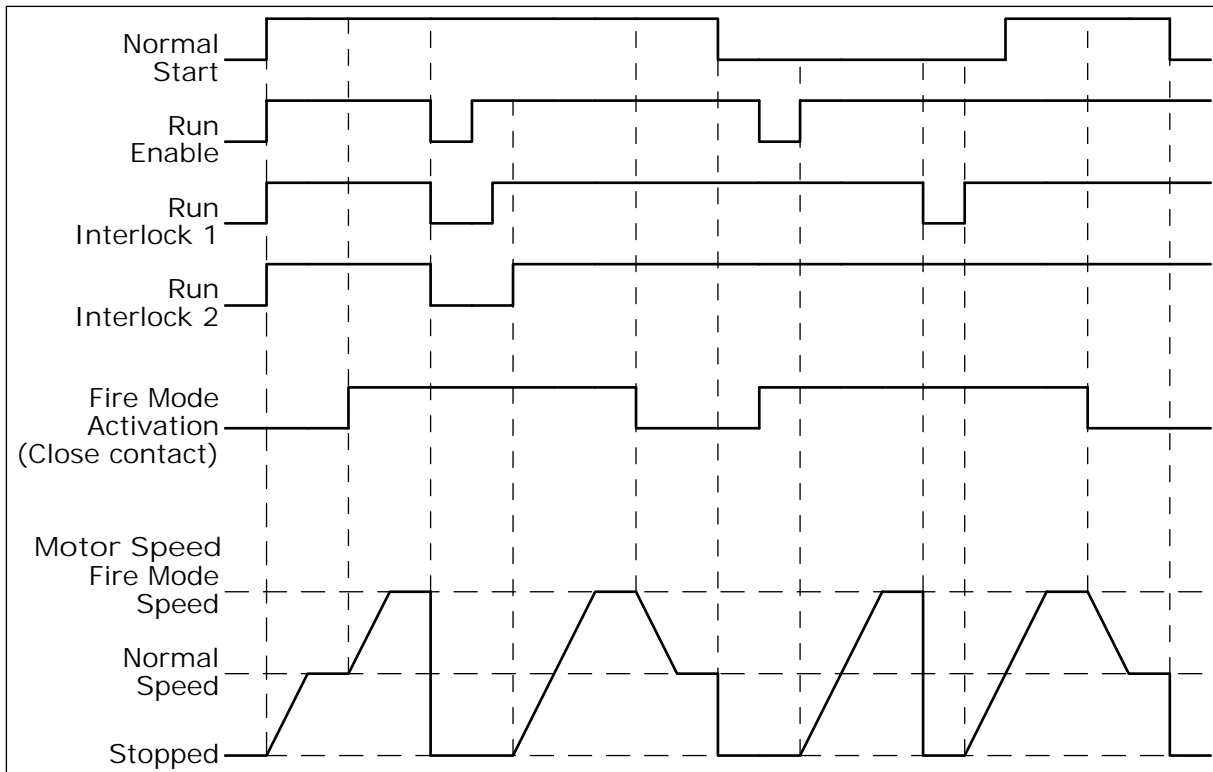

Fig. 86: The Fire mode function

P3.17.5 FIRE MODE ACTIVATION ON CLOSE (ID 1619)

The type of this digital input signal is NO (normally open). See the description for P3.17.4 Fire Mode Activation on Open.

P3.17.6 FIRE MODE REVERSE (ID 1618)

Use this parameter to make a selection of the rotation direction of the motor during Fire mode. The parameter does not have an effect in normal operation.

If it is necessary for the motor to operate always FORWARD or always REVERSE in Fire Mode, make a selection of the correct digital input.

DigIn Slot0.1 = always FORWARD

DigIn Slot0.2 = always REVERSE

9.16 MOTOR PREHEAT FUNCTION

P3.18.1 MOTOR PREHEAT FUNCTION (ID 1225)

The Motor preheat function keeps the drive and the motor warm during the STOP status. In the motor preheat, the system gives the motor a DC current. The motor preheat prevents for example condensation.

Selection number	Selection name	Description
0	Not used	The Motor preheat function is disabled.
1	Always in Stop state	The Motor preheat function is activated always when the drive is in the Stop state.
2	Controlled by digital input	The Motor preheat function is activated by a digital input signal, when the drive is in the Stop state. You can make the selection of the digital input for the activation with parameter P3.5.1.18.
3	Temperature limit (heatsink)	The Motor preheat function is activated if the drive is in the Stop state, and the temperature of the heatsink of the drive goes below the temperature limit that was set with parameter P3.18.2.
4	Temperature limit (measured motor temperature)	The Motor preheat function is activated if the drive is in the Stop state, and the measured motor temperature goes below the temperature limit that was set with parameter P3.18.2. You can set the measurement signal of the motor temperature with parameter P3.18.5. NOTE! To use this operation mode, you must have an option board for temperature measurement (for example OPT-BH).

9.17 MECHANICAL BRAKE

You can monitor the mechanical brake with the monitoring value Application Status Word 1 in the monitoring group Extras and advanced.

The Mechanical brake control function controls an external mechanical brake with a digital output signal. The mechanical brake is opened/closed when the drive output frequency breaks the opening/closing limits.

P3.20.1 BRAKE CONTROL (ID 1541)

Table 121: The selection of the operation mode of the mechanical brake

Selection number	Selection name	Description
0	Disabled	The mechanical brake control is not used.
1	Enabled	The mechanical brake control is used, but there is no supervision of the brake status.
2	Enabled with brake status supervision	The mechanical brake control is used, and a digital input signal monitors the brake status (P3.20.8).

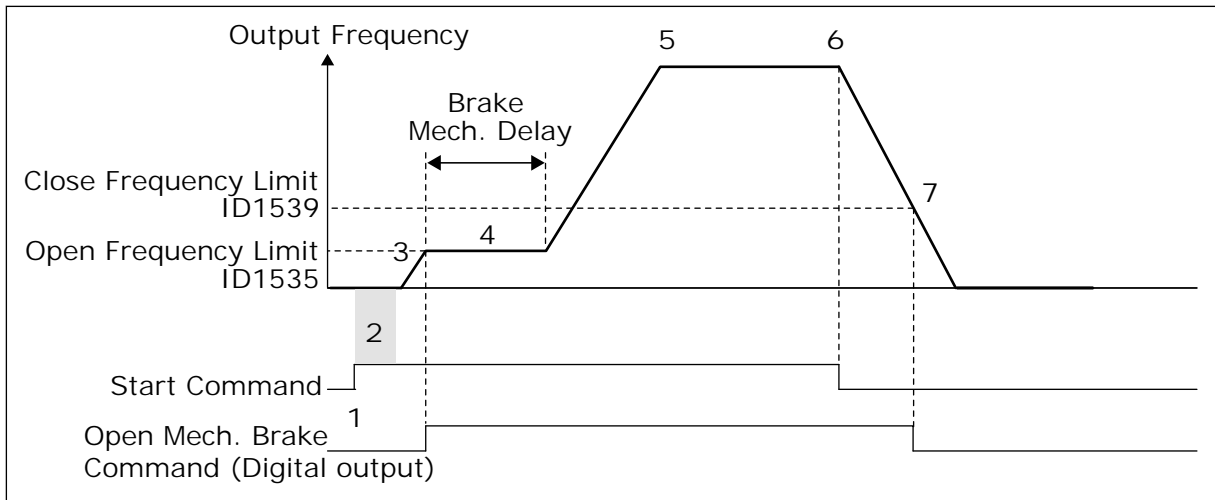

Fig. 87: The Mechanical brake function

1. A Start command is given.
2. We recommend that you use start magnetisation to build rotor flux fast and to decrease the time when the motor can produce nominal torque.
3. When the start magnetisation time is over, the system lets the the frequency reference go to the open frequency limit.
4. The mechanical brake opens. The frequency reference stays at the open frequency limit until the brake mechanical delay is over, and the correct brake feedback signal is received.
5. The output frequency of the drive follows the normal frequency reference.
6. A Stop command is given.
7. The mechanical brake becomes closed when the output frequency goes below the close frequency limit.

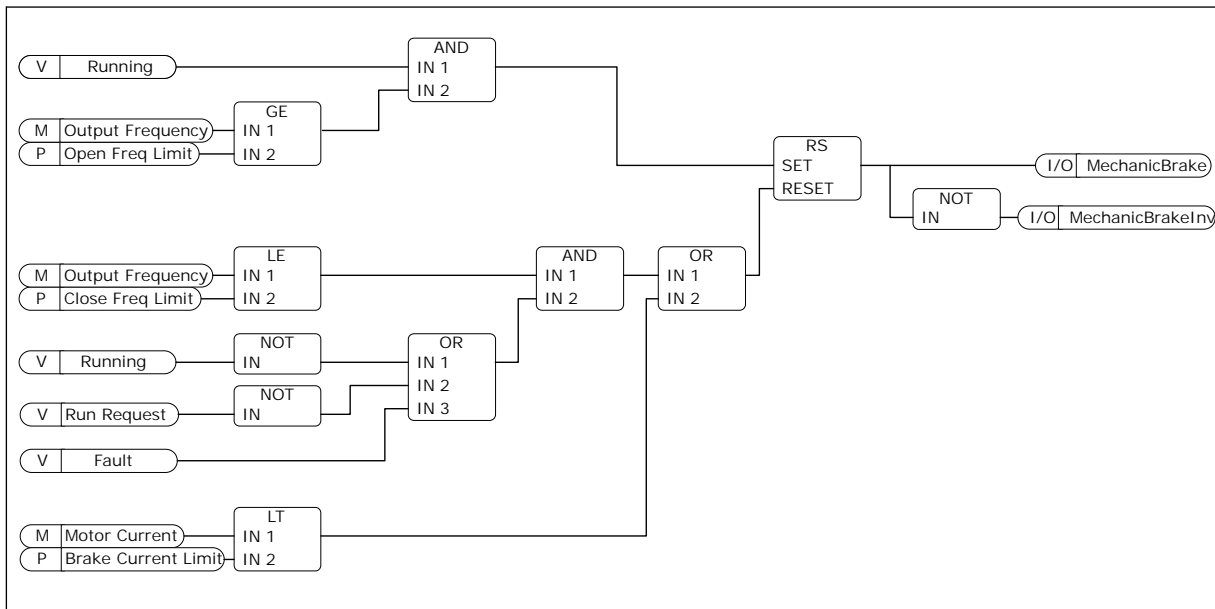

Fig. 88: The mechanical brake opening logic

P3.20.2 BRAKE MECHANICAL DELAY (ID 353)

After the brake opening command is given, the speed stays at the value of the parameter P3.20.3 (Brake Opening Frequency Limit) until the brake mechanical delay is expired. Set the delay time to agree with the reaction time of the mechanical brake.

The Brake mechanical delay function is used to prevent current and/or torque spikes. This prevents the motor from operating at full speed against the brake. If you use P3.20.2 at the same time with P3.20.8, it is necessary to have the expired delay and the feedback signal to release the speed reference.

P3.20.3 BRAKE OPENING FREQUENCY LIMIT (ID 1535)

The value of the parameter P3.20.3 is the output frequency limit of the drive to open the mechanical brake. In open loop control, we recommend that you use a value that is equal to the nominal slip of the motor.

The output frequency of the drive stays at this level until the brake mechanical delay is expired, and the system receives the correct brake feedback signal.

P3.20.4 BRAKE CLOSING FREQUENCY LIMIT (ID 1539)

The value of the parameter P3.20.4 is the output frequency limit of the drive to close the mechanical brake. The drive stops and the output frequency goes near 0. You can use the parameter for the 2 directions, positive and negative.

P3.20.5 BRAKE CURRENT LIMIT (ID 1085)

The Mechanical brake closes immediately if the motor current is below the limit set in parameter Brake Current Limit. We recommend that you set the value to approximately half of the magnetisation current.

When the drive operates on the field weakening area, the brake current limit decreases automatically as a function of output frequency.

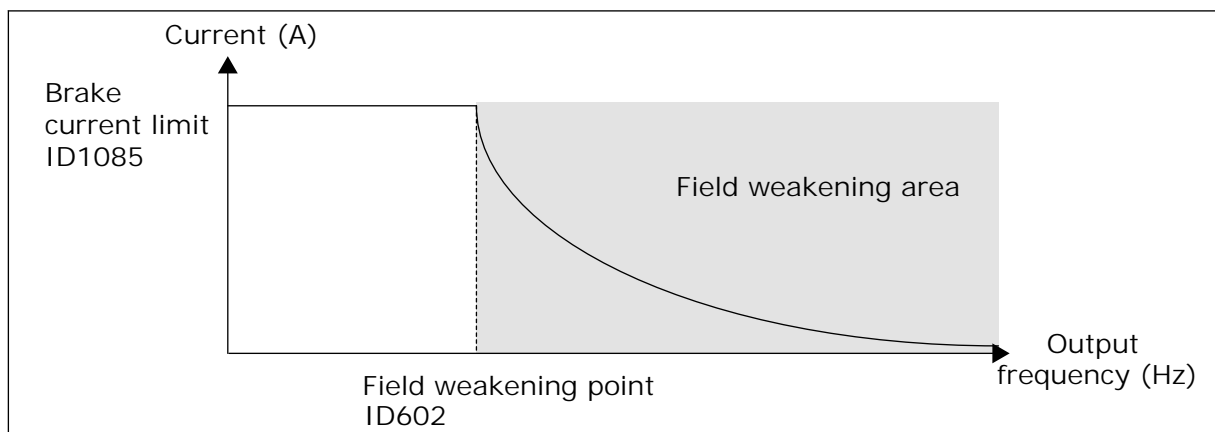

Fig. 89: Internal reduction of the brake current limit

P3.20.8 (P3.5.1.44) BRAKE FEEDBACK (ID 1210)

This parameter includes the digital input selection for the status signal of the mechanical brake. The Brake feedback signal is used if the value for parameter P3.20.1 is *Enabled with brake status supervision*.

Connect this digital input signal to an auxiliary contact of the mechanical brake.

The contact is open = the mechanical brake is closed
The contact is closed = the mechanical brake is open

If the brake opening command is given, but the contact of the brake feedback signal does not close in given time, a mechanical brake fault shows (fault code 58).

9.18 PUMP CONTROL

9.18.1 AUTO-CLEANING

Use the Auto-cleaning function to remove dirt or other material from the pump impeller. You can also use the function to clear a blocked pipe or valve. You can use the auto-cleaning, for example, in wastewater systems to keep the performance of the pump satisfactory.

P3.21.1.1 CLEANING FUNCTION (ID 1714)

If you enable the parameter Cleaning Function, the auto-cleaning starts, and activates the digital input signal in parameter P3.21.1.2.

P3.21.1.2 CLEANING ACTIVATION (ID 1715)

P3.21.1.3 CLEANING CYCLES (ID 1716)

The parameter Cleaning Cycles tells how many times the forward or the reverse cleaning cycle is done.

P3.21.1.4 CLEAN FORWARD FREQUENCY (ID 1717)

The Auto-cleaning function accelerates and decelerates the pump to remove the dirt.

You can set the frequency and time of the cleaning cycle with the parameters P3.21.1.4, P3.21.1.5, P3.21.1.6 and P3.21.1.7.

P3.21.1.5 CLEAN FORWARD TIME (ID 1718)

See parameter P3.21.1.4 Clean Forward Frequency.

P3.21.1.6 CLEAN REVERSE FREQUENCY (ID 1719)

See parameter P3.21.1.4 Clean Forward Frequency.

P3.21.1.7 CLEAN REVERSE TIME (ID 1720)

See parameter P3.21.1.4 Clean Forward Frequency.

P3.21.1.8 CLEANING ACCELERATION TIME (ID 1721)

You can set acceleration and deceleration ramps for the Auto-cleaning function with parameters P3.21.1.8 and P3.21.1.9.

P3.21.1.9 CLEANING DECELERATION TIME (ID 1722)

You can set acceleration and deceleration ramps for the Auto-cleaning function with parameters P3.21.1.8 and P3.21.1.9.

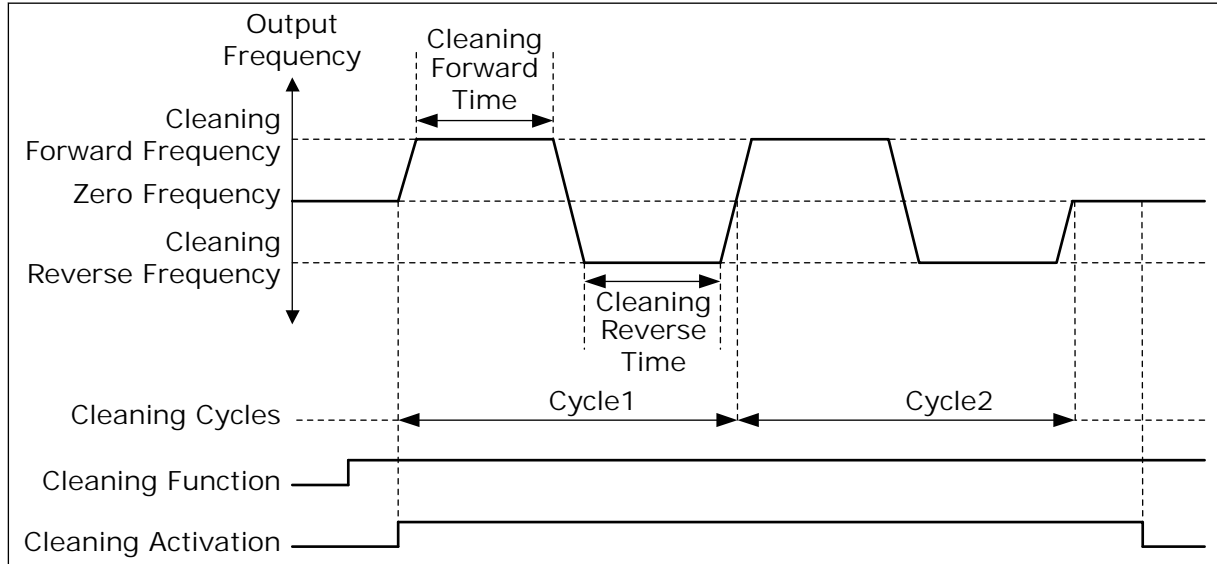

Fig. 90: The Auto-cleaning function

9.18.2 JOCKEY PUMP

P3.21.2.1 JOCKEY FUNCTION (ID 1674)

A Jockey pump is a smaller pump that keeps the pressure in the pipeline, when the main pump is in the sleep mode. This can occur, for example, in the night.

The Jockey pump function controls a jockey pump with a digital output signal. You can use a jockey pump if a PID controller is used to control the main pump. The function has 3 operation modes.

Selection number	Selection name	Description
0	Not used	
1	PID sleep	The jockey pump starts when the PID Sleep of the main pump activates. The jockey pump stops when the main pump wakes up from the sleep mode.
2	PID sleep (level)	The jockey pump starts when the PID Sleep activates, and the PID feedback signal is less than the level set by parameter P3.21.2.2. The jockey pump stops when the PID feedback signal is more than the level set in parameter P3.21.2.3 or the main pump wakes up from the sleep mode.

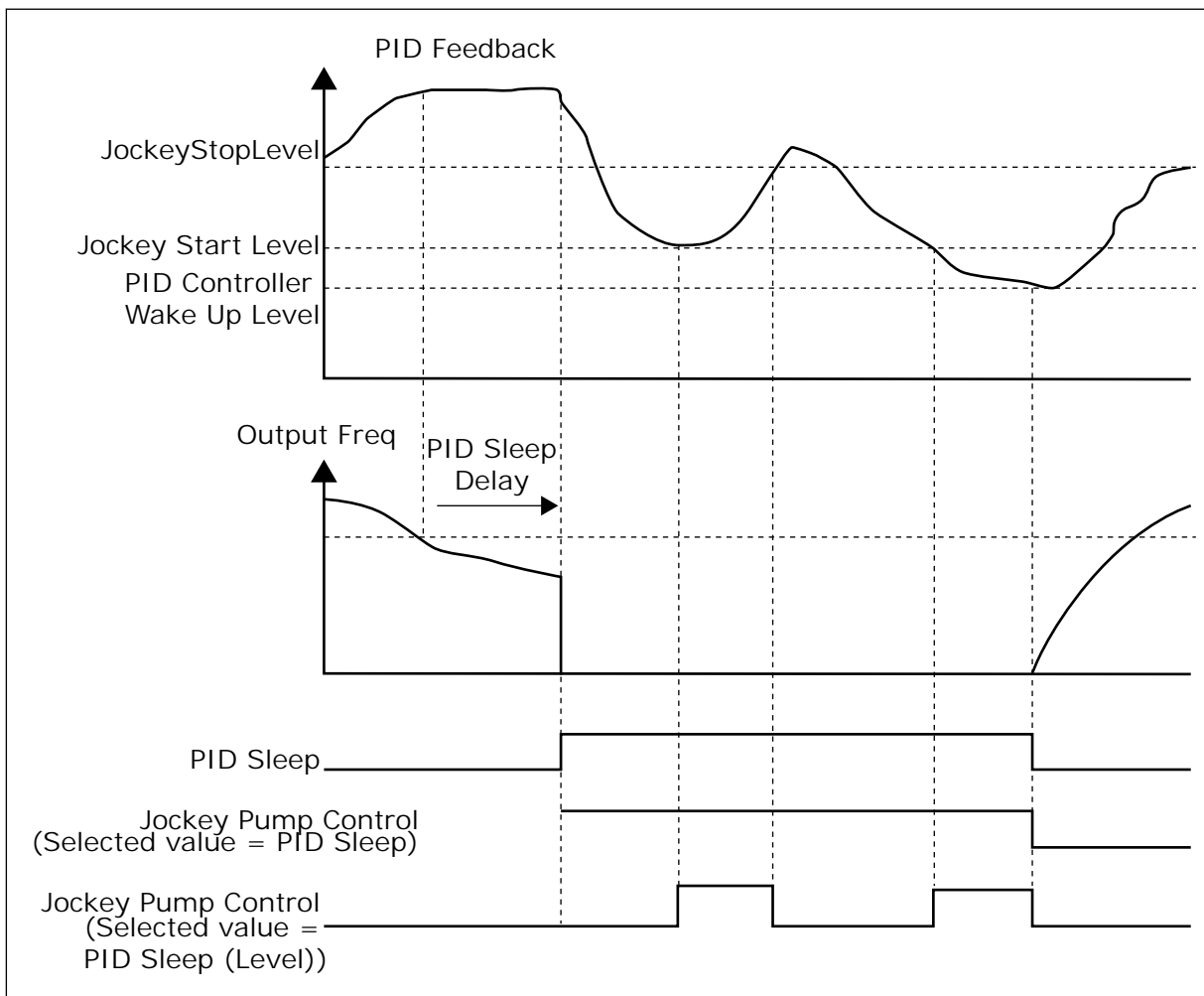

Fig. 91: The Jockey pump function

9.18.3 PRIMING PUMP

A priming pump is a smaller pump that primes the inlet of the main pump to prevent suction of air.

The priming pump function controls a priming pump with a digital output signal. You can set a delay to start the priming pump before the main pump starts. The priming pump operates continuously while the main pump operates.

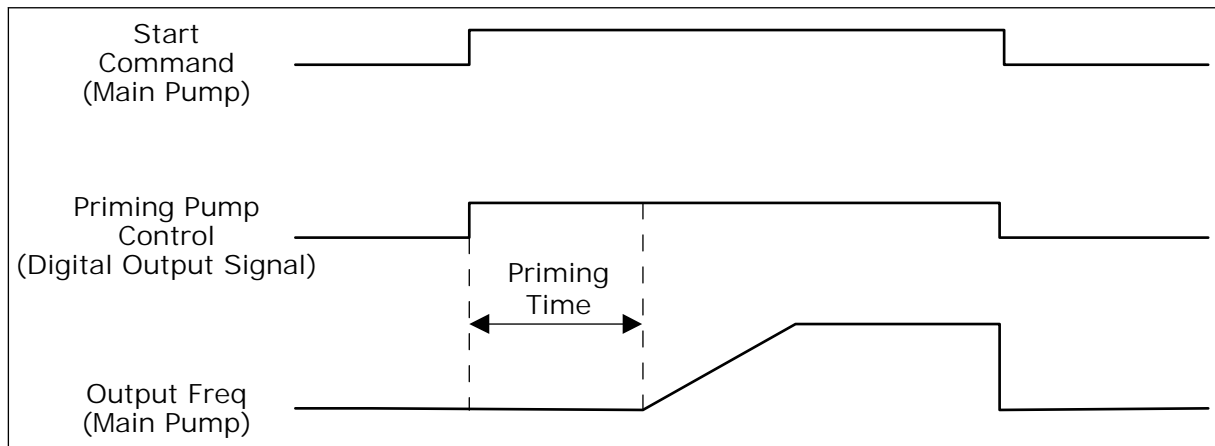

Fig. 92: The Priming pump function

P3.21.3.1 PRIMING FUNCTION (ID 1677)

Parameter P3.21.3.1 enables the control of an external priming pump with a digital output. You must first set *priming pump control* as the value of the digital output.

P3.21.3.2 PRIMING TIME (ID 1678)

The value of this parameter tells how much before the start of the main pump the priming pump must start.

9.19 TOTAL AND TRIP COUNTERS

The Vacon® AC drive has different counters based on the operation time of the drive and the energy consumption. Some of the counters measure total values and some can be reset.

The energy counters measure the energy that is taken from the supply network. The other counters are used to measure, for example, the operation time of the drive or the run time of the motor.

It is possible to monitor all the counter values from the PC, keypad or fieldbus. If you use the keypad or the PC, you can monitor the counter values in the Diagnostics menu. If you use fieldbus, you can read the counter values with the ID numbers. In this chapter, you find data on these ID numbers.

9.19.1 OPERATING TIME COUNTER

It is not possible to reset the operating time counter of the control unit. The counter is in the submenu Total counters. The value of the counter has 5 different 16-bit values. To read the value of the counter through fieldbus, use these ID numbers.

- ID 1754 Operating Time Counter (years)
- ID 1755 Operating Time Counter (days)
- ID 1756 Operating Time Counter (hours)
- ID 1757 Operating Time Counter (minutes)
- ID 1758 Operating Time Counter (seconds)

Example: You receive the value *1a 143d 02:21* of the operating time counter from the fieldbus.

- ID1754: 1 (years)
- ID1755: 143 (days)
- ID1756: 2 (hours)
- ID1757: 21 (minutes)
- ID1758: 0 (seconds)

9.19.2 OPERATING TIME TRIP COUNTER

The operating time trip counter of the control unit can be reset. It is in the submenu Trip counters. It is possible to reset the counter with the PC, the control panel, or the fieldbus. The value of the counter has 5 different 16-bit values. To read the value of the counter through fieldbus, use these ID numbers.

- ID 1766 Operating Time Trip Counter (years)
- ID 1767 Operating Time Trip Counter (days)
- ID 1768 Operating Time Trip Counter (hours)
- ID 1769 Operating Time Trip Counter (minutes)
- ID 1770 Operating Time Trip Counter (seconds)

Example: You receive the value *1a 143d 02:21* of the operating time trip counter from the fieldbus.

- ID1766: 1 (years)
- ID1767: 143 (days)
- ID1768: 2 (hours)
- ID1769: 21 (minutes)
- ID1770: 0 (seconds)

ID 2311 OPERATING TIME TRIP COUNTER RESET

You can reset the operating time trip counter with the PC, the control panel, or the fieldbus. If you use the PC or the control panel, reset the counter in the Diagnostics menu.

If you use the fieldbus, to reset the counter, set a rising edge (0 => 1) to ID2311 Operating Time Trip Counter Reset.

9.19.3 RUN TIME COUNTER

The run time counter of the motor cannot be reset. It is in the submenu Total counters. The value of the counter has 5 different 16-bit values. To read the value of the counter through fieldbus, use these ID numbers.

- ID 1772 Run Time Counter (years)
- ID 1773 Run Time Counter (days)
- ID 1774 Run Time Counter (hours)
- ID 1775 Run Time Counter (minutes)
- ID 1776 Run Time Counter (seconds)

Example: You receive the value *1a 143d 02:21* of the run time counter from the fieldbus.

- ID1772: 1 (years)
- ID1773: 143 (days)
- ID1774: 2 (hours)
- ID1775: 21 (minutes)
- ID1776: 0 (seconds)

9.19.4 POWER ON TIME COUNTER

The power on time counter of the power unit is in the submenu Total counters. It is not possible to reset the counter. The value of the counter has 5 different 16-bit values. To read the value of the counter through fieldbus, use these ID numbers.

- ID 1777 Power On Time Counter (years)
- ID 1778 Power On Time Counter (days)
- ID 1779 Power On Time Counter (hours)
- ID 1780 Power On Time Counter (minutes)
- ID 1781 Power On Time Counter (seconds)

Example: You receive the value *1a 240d 02:18* of the power on time counter from the fieldbus.

- ID1777: 1 (years)
- ID1778: 240 (days)
- ID1779: 2 (hours)
- ID1780: 18 (minutes)
- ID1781: 0 (seconds)

9.19.5 ENERGY COUNTER

The energy counter counts the total quantity of energy that the drive gets from the supply network. The counter cannot be reset. To read the value of the counter through fieldbus, use these ID numbers.

ID 2291 Energy Counter

The value has always 4 digits. The format and the unit of the counter change to agree with the energy counter value. See the example below.

Example:

- 0.001 kWh
- 0.010 kWh
- 0.100 kWh
- 1.000 kWh
- 10.00 kWh
- 100.0 kWh
- 1.000 MWh
- 10.00 MWh
- 100.0 MWh
- 1.000 GWh
- etc...

ID2303 Energy Counter Format

The energy counter format gives the position of the decimal point in the value of the Energy Counter.

- 40 = 4 digits, 0 fractional digits
- 41 = 4 digits, 1 fractional digit
- 42 = 4 digits, 2 fractional digits
- 43 = 4 digits, 3 fractional digits

Example:

- 0.001 kWh (Format = 43)
- 100.0 kWh (Format = 41)
- 10.00 MWh (Format = 42)

ID2305 Energy Counter Unit

The energy counter unit gives the unit for the value of the Energy Counter.

- 0 = kWh
- 1 = MWh
- 2 = GWh
- 3 = TWh
- 4 = PWh

Example: If you receive the value 4500 from ID2291, the value 42 from ID2303, and the value 0 from ID2305, the result is 45.00 kWh.

9.19.6 ENERGY TRIP COUNTER

The energy trip counter counts the quantity of energy that the drive gets from the supply network. The counter is in the submenu Trip counters. You can reset the counter with the PC, the control panel, or the fieldbus. To read the value of the counter through fieldbus, use these ID numbers.

ID 2296 Energy Trip Counter

The value has always 4 digits. The format and the unit of the counter change to agree with the energy trip counter value. See the example below. You can monitor the energy counter

format and unit with ID2307 Energy Trip Counter Format and ID2309 Energy trip Counter unit.

Example:

- 0.001 kWh
- 0.010 kWh
- 0.100 kWh
- 1.000 kWh
- 10.00 kWh
- 100.0 kWh
- 1.000 MWh
- 10.00 MWh
- 100.0 MWh
- 1.000 GWh
- etc...

ID2307 Energy Trip Counter Format

The energy trip counter format gives the position of the decimal point in the value of the Energy Trip Counter.

- 40 = 4 digits, 0 fractional digits
- 41 = 4 digits, 1 fractional digit
- 42 = 4 digits, 2 fractional digits
- 43 = 4 digits, 3 fractional digits

Example:

- 0.001 kWh (Format = 43)
- 100.0 kWh (Format = 41)
- 10.00 MWh (Format = 42)

ID2309 Energy Trip Counter Unit

The energy trip counter unit gives the unit for the value of the Energy Trip Counter.

- 0 = kWh
- 1 = MWh
- 2 = GWh
- 3 = TWh
- 4 = PWh

ID2312 Energy Trip Counter Reset

To reset the energy trip counter, use the PC, the control panel, or the fieldbus. If you use the PC or the control panel, reset the counter in the Diagnostics menu. If you use the fieldbus, set a rising edge to ID2312 Energy Trip Counter Reset.

10 FAULT TRACING

When the control diagnostics of the AC drive find an unusual condition in the operation of the drive, the drive shows a notification about it. You can see the notification on the display of the control panel. The display shows the code, the name and a short description of the fault or alarm.

The source info tells you the source of the fault, what caused it, where it occurred, and other data.

There are 3 different types of notification.

- An info does not have an effect the operation of the drive. You must reset the info.
- An alarm informs you of unusual operation on the drive. It does not stop the drive. You must reset the alarm.
- A fault stops the drive. You must reset the drive and find a solution to the problem.

You can program different responses for some faults in the application. See more in Chapter 5.9 Group 3.9: Protections.

Reset the fault with the Reset button on the keypad, or through the I/O terminal, fieldbus or the PC tool. The faults stay in the Fault history where you can go and examine them. See the different fault codes in Chapter 10.3 Fault codes.

Before you contact the distributor or the factory because of unusual operation, prepare some data. Write down all the texts on the display, the fault code, the fault ID, the source info, the Active Faults list and the Fault History.

10.1 A FAULT COMES INTO VIEW

When the drive shows a fault and stops, examine the cause of fault, and reset the fault.

There are 2 procedures to reset a fault: with the Reset button and with a parameter.

RESETTING WITH THE RESET BUTTON

- 1 Push the Reset button on the keypad for 2 secods.

RESETTING WITH A PARAMETER IN THE GRAPHICAL DISPLAY

- 1 Go to the Diagnostics Menu.

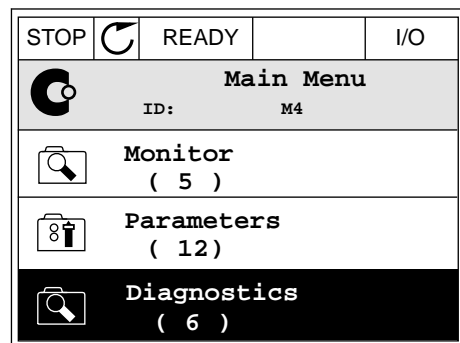

- Go to the submenu Reset faults.

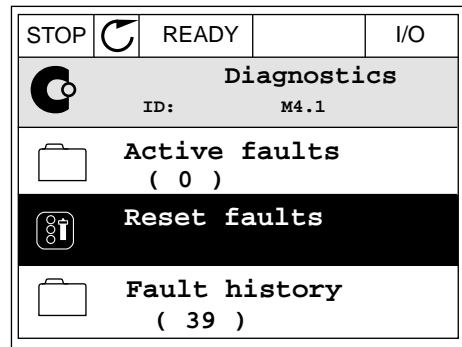

- Make a selection of the parameter Reset Faults.

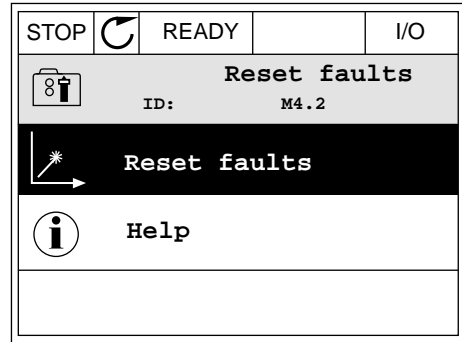

RESETTING WITH A PARAMETER IN THE TEXT DISPLAY

- Go to the Diagnostics menu.



- Use the arrow buttons Up and Down to find the parameter Reset Faults.

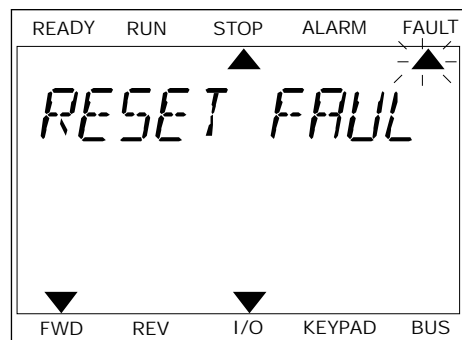

- 3 Make a selection of the value Yes and push OK.

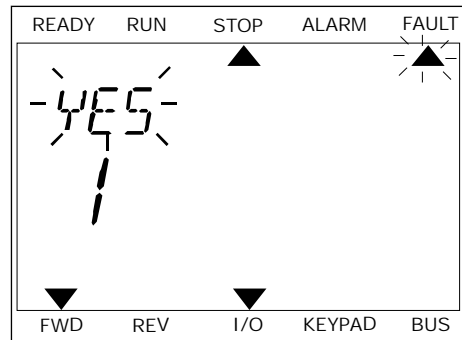

10.2 FAULT HISTORY

In the Fault history, you can find more data on the faults. There is a maximum number of 40 faults in the Fault history.

EXAMINING THE FAULT HISTORY IN THE GRAPHICAL DISPLAY

- 1 To see more data on a fault, go to Fault history.

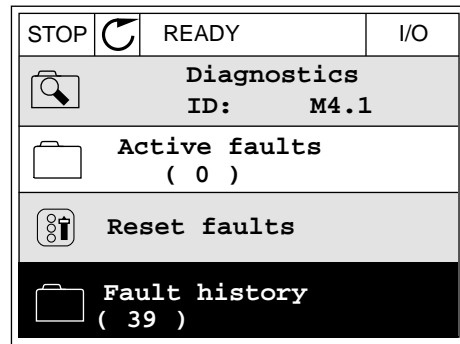

- 2 To examine the data of a fault, push the Arrow button Right.

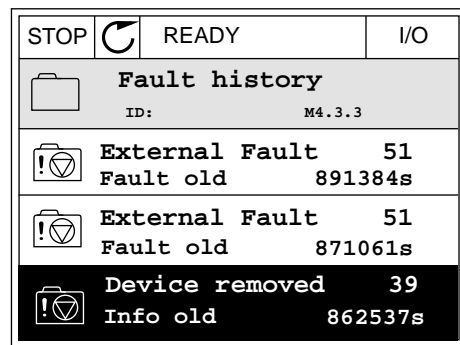

- 3 You see the data in a list.

STOP	READY	I/O
Fault history		
ID:		M4.3.3.2
Code	39	
ID	380	
State	Info old	
Date	7.12.2009	
Time	04:46:33	
Operating time	862537s	
Source 1		
Source 2		
Source 3		

EXAMINING THE FAULT HISTORY IN THE TEXT DISPLAY

- 1 Push OK to go to Fault history.

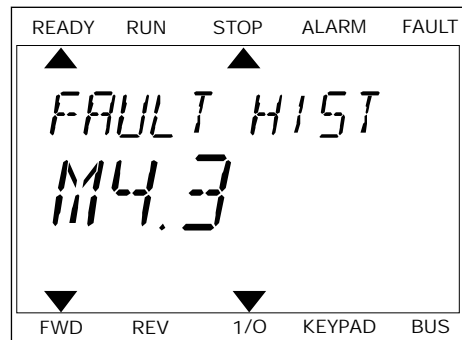

- 2 To examine the data of a fault, push OK again.



3 Use the arrow button down to examine all the data.

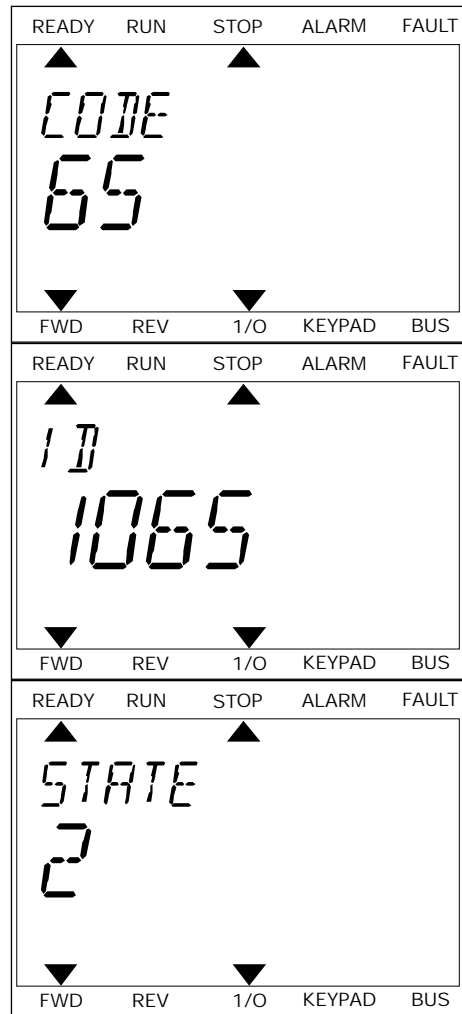

10.3 FAULT CODES

Fault code	Fault ID	Fault name	Possible cause	How to correct the fault
1	1	Overcurrent (hardware fault)	<p>There is too high a current (>4*I_H) in the motor cable. Its cause can be 1 of these.</p> <ul style="list-style-type: none"> • a sudden heavy load increase • a short circuit in the motor cables • the motor is not the correct type • the parameter settings are not properly made 	Do a check of the loading. Do a check of the motor. Do a check of the cables and connections. Make an identification run. Set the acceleration time longer (P3.4.1.2 and P3.4.2.2).
	2	Overcurrent (software fault)		
2	10	Overvoltage (hardware fault)	<p>The DC-link voltage is higher than the limits.</p> <ul style="list-style-type: none"> • too short a deceleration time • high overvoltage spikes in the supply 	Set the deceleration time longer (P3.4.1.3 and P3.4.2.3). Use the brake chopper or the brake resistor. They are available as options. Activate the overvoltage controller. Do a check of the input voltage.
	11	Overvoltage (software fault)		
3	20	Earth fault (hardware fault)	<p>The measurement of current tells that the sum of the motor phase current is not zero.</p> <ul style="list-style-type: none"> • an insulation malfunction in the cables or the motor • a filter (du/dt, sinus) malfunction 	Do a check of the motor cables and the motor. Do a check of the filters.
	21	Earth fault (software fault)		
5	40	Charging switch	<p>The charging switch is closed and the feedback information is OPEN.</p> <ul style="list-style-type: none"> • operation malfunction • defective component 	Reset the fault and restart the drive. Do a check of the feedback signal and the cable connection between the control board and the power board. If the fault occurs again, ask instructions from the distributor near to you.
7	60	Saturation	<ul style="list-style-type: none"> • Defective IGBT • de-saturation short circuit in the IGBT • a short circuit or an overload in the brake resistor 	This fault cannot be reset from the control panel. Switch off the power. DO NOT RESTART THE DRIVE or CONNECT THE POWER! Ask instructions from the factory.

Fault code	Fault ID	Fault name	Possible cause	How to correct the fault
8	600	System fault	There is no communication between the control board and the power.	Reset the fault and restart the drive. Download the latest software from the Vacon website. Update the drive with it. If the fault occurs again, ask instructions from the distributor near to you.
	601		Defective component. Operation malfunction.	
	602		Defective component. Operation malfunction. The voltage of auxiliary power in the power unit is too low.	
	603		Defective component. Operation malfunction. Output phase voltage does not agree to the reference. Feedback fault.	
	604		Defective component. Operation malfunction.	
	605		The software of the control unit is not compatible with the software of the power unit.	
	606		The software version cannot be read. There is no software in the power unit. Defective component. Operation malfunction (a problem in the power board or the measurement board).	
	607		A CPU overload.	
	608			Defective component. Operation malfunction.

Fault code	Fault ID	Fault name	Possible cause	How to correct the fault
8	610	System fault	Defective component. Operation malfunction.	Reset the fault and restart. Download the latest software from the Vacon website. Update the drive with it. If the fault occurs again, ask instructions from the distributor near to you.
	614		Configuration error. Software error. Defective component (a defective control board). Operation malfunction.	
	647		Defective component. Operation malfunction.	
	648		Operation malfunction. The system software is not compatible with the application.	
	649		A resource overload. A parameter loading, restoring or saving malfunction.	Load the factory default settings. Download the latest software from the Vacon website. Update the drive with it.
9	80	Undervoltage (fault)	<p>The DC-link voltage is lower than the limits.</p> <ul style="list-style-type: none"> • too low a supply voltage • defective component • a defective input fuse • the external charge switch is not closed <p>NOTE!</p> <p>This fault becomes active only if the drive is in Run state.</p>	If there is a temporary supply voltage break, reset the fault and restart the drive. Do a check of the supply voltage. If the supply voltage is sufficient, there is an internal fault. Examine the electrical network for fault. Ask instructions from the distributor near to you.
10	91	Input phase	<ul style="list-style-type: none"> • supply voltage malfunction • a defective fuse or malfunction in the supply cables <p>The load must be a minimum of 10-20% for the supervision to work.</p>	Do a check of the supply voltage, the fuses and supply cable, the rectifying bridge and the gate control of the thyristor (MR6->).

Fault code	Fault ID	Fault name	Possible cause	How to correct the fault
11	100	Output phase supervision	<p>The measurement of current tells that there is no current in 1 motor phase.</p> <ul style="list-style-type: none"> • a motor or motor cables malfunction • filter (du/dt, sinus) malfunction 	Do a check of the motor cable and the motor. Do a check of the du/dt or sinus filter.
12	110	Brake chopper supervision (hardware fault)	<p>There is no brake resistor. The brake resistor is broken. A defective brake chopper.</p>	Do a check of the brake resistor and the cabling. If they are in good condition, there is a fault in the resistor or the chopper. Ask instructions from the distributor near to you.
	111	Brake chopper saturation alarm		
13	120	AC drive undertemperature (fault)	Too low a temperature in the heatsink of the power unit or in the power board.	The ambient temperature is too low for the drive. Move the drive in a warmer position.
14	130	AC drive overtemperature (fault, heatsink)	<p>Too high a temperature in the heatsink of the power unit or in the power board. The temperature limits of the heatsink are different in all the frames.</p>	Do a check of the actual amount and flow of cooling air. Examine the heatsink for dust. Do a check of the ambient temperature. Make sure that the switching frequency is not too high in relation to the ambient temperature and the motor load. Do a check of the cooling fan.
	131	AC drive overtemperature (alarm, heatsink)		
	132	AC drive overtemperature (fault, board)		
	133	AC drive overtemperature (alarm, board)		
15	140	Motor stall	The motor stalled.	Do a check of the motor and the load.
16	150	Motor overtemperature	There is too heavy a load on the motor.	Decrease the motor load. If there is no motor overload, do a check of the motor thermal protection parameters (parameter group 3.9 Protections).
17	160	Motor underload	There is not a sufficient load on the motor.	Do a check of the load. Do a check of the parameters. Do a check of the du/dt and sinus filters.

Fault code	Fault ID	Fault name	Possible cause	How to correct the fault
19	180	Power overload (short-time supervision)	The power of the drive is too high.	Decrease the load. Examine the dimensions of drive. Examine if it is too small for the load.
	181	Power overload (long-time supervision)		
25	240	Motor control fault	<p>This fault is available only if you use a customer-specific application. A malfunction in the start angle identification.</p> <ul style="list-style-type: none"> • The rotor moves during identification. • The new angle does not agree with the old value. 	Reset the fault and restart the drive. Increase the identification current. See the fault history source for more information.
	241			
26	250	Start-up prevented	It is not possible to do a start-up of the drive. When the Run request is ON, a new software (a firmware or an application), a parameter setting or other file that effects the operation of the drive, is loaded to drive.	Reset the fault and stop the drive. Load the software and start the drive.
29	280	Atex thermistor	The ATEX thermistor tells that there is an overtemperature.	Reset the fault. Do a check of the thermistor and its connections.

Fault code	Fault ID	Fault name	Possible cause	How to correct the fault
30	290	Safe Off	The safe Off signal A does not let you to set the drive to the READY state.	Reset the fault and restart the drive. Do a check of the signals from the control board to the power unit and the D connector.
	291	Safe Off	The safe Off signal B does not let you to set the drive to the READY state.	
	500	Safety configuration	The safety configuration switch was installed.	Remove the safety configuration switch from the control board.
	501	Safety configuration	There are too many STO option boards. It is possible to have only 1.	Keep 1 of the STO option boards. Remove the others. See the safety manual.
	502	Safety configuration	The STO option board was installed in an incorrect slot.	Put the STO option board into the correct slot. See the safety manual.
	503	Safety configuration	There is no safety configuration switch on the control board.	Install the safety configuration switch on the control board. See the safety manual.
	504	Safety configuration	The safety configuration switch was installed incorrectly on the control board.	Install the safety configuration switch into the correct position on the control board. See the safety manual.
	505	Safety configuration	The safety configuration switch was installed incorrectly on the STO option board.	Do a check of the installation of the safety configuration switch on the STO option board. See the safety manual.
	506	Safety configuration	There is no communication with the STO option board.	Do a check of the installation of the STO option board. See the safety manual.
	507	Safety configuration	The STO option board is not compatible with the hardware.	Reset the drive and restart it. If the fault occurs again, ask instructions from your nearest distributor.

Fault code	Fault ID	Fault name	Possible cause	How to correct the fault
30	520	Safety diagnostics	The STO inputs have a different status.	Do a check of the external safety switch. Do a check of the input connection and cable of the safety switch. Reset the drive and restart. If the fault occurs again, ask instructions from your nearest distributor.
	521	Safety diagnostics	A malfunction in the ATEX thermistor diagnostic. There is no connection in the ATEX thermistor input.	Reset the drive and restart. If the fault occurs again, change the option board.
	522	Safety diagnostics	A short-circuit in the connection of the ATEX thermistor input.	Do a check of the ATEX thermistor input connection. Do a check of the external ATEX connection. Do a check of the external ATEX thermistor.
	523	Safety diagnostics	A problem occurred in the internal safety circuit.	Reset the drive and restart. If the fault occurs again, ask instructions from your nearest distributor.
	524	Safety diagnostics	An overvoltage in the safety option board	Reset the drive and restart. If the fault occurs again, ask instructions from your nearest distributor.
	525	Safety diagnostics	An undervoltage in the safety option board	Reset the drive and restart. If the fault occurs again, ask instructions from your nearest distributor.
	526	Safety diagnostics	An internal malfunction in the safety option board CPU or in the memory handling	Reset the drive and restart. If the fault occurs again, ask instructions from your nearest distributor.
	527	Safety diagnostics	An internal malfunction in the safety function	Reset the drive and restart. If the fault occurs again, ask instructions from your nearest distributor.
	530	Safe torque off	An emergency stop was connected or some other STO operation was activated.	When the STO function is activated, the drive is in safe state.
32	311	Fan cooling	The fan speed does not agree to the speed reference accurately, but the drive operates correctly. This fault shows only in the MR7 and in the drives that bigger than MR7.	Reset the fault and restart the drive. Clean or replace the fan.
	312	Fan cooling	The fan life time (that is, 50,000 h) is complete.	Replace the fan and reset the life time counter of the fan.

Fault code	Fault ID	Fault name	Possible cause	How to correct the fault
33	320	Fire mode enabled	The Fire mode of the drive is enabled. The protections of the drive are not used. This alarm is reset automatically when Fire mode is disabled.	Do a check of the parameter settings and the signals. Some of the protections of the drive are disabled.
37	361	Device changed (same type)	The power unit was replaced by a new one that has the same size. The device is ready to be used. The parameters are available in the drive.	Reset the fault. The drive reboots after you reset the fault.
	362	Device changed (same type)	The option board in slot B was replaced by a new one that you have used before in the same slot. The device is ready to be used.	Reset the fault. The drive starts to use the old parameter settings.
	363	Device changed (same type)	The same cause as in ID362, but refers to Slot C.	
	364	Device changed (same type)	The same cause as in ID362, but refers to Slot D.	
	365	Device changed (same type)	The same cause as in ID362, but refers to Slot E.	
38	372	Device added (same type)	An option board was put into slot B. You have used the option board before in the same slot. The device is ready to be used.	The device is ready for use. The drive starts to use the old parameter settings.
	373	Device added (same type)	The same cause as in ID372, but refers to Slot C.	
	374	Device added (same type)	The same cause as in ID372, but refers to Slot D.	
	375	Device added (same type)	The same cause as in ID372, but refers to Slot E.	
39	382	Device removed	An option board was removed from slot A or B.	The device is not available. Reset the fault.
	383	Device removed	The same cause as in ID380, but refers to Slot C	
	384	Device removed	The same cause as in ID380, but refers to Slot D	
	385	Device removed	The same cause as in ID380, but refers to Slot E	

Fault code	Fault ID	Fault name	Possible cause	How to correct the fault
40	390	Device unknown	An unknown device was connected (the power unit/ option board)	The device is not available. If the fault occurs again, ask instructions from your nearest distributor.
41	400	IGBT temperature	The calculated IGBT temperature is too high. <ul style="list-style-type: none"> • too high a motor load • too high an ambient temperature • hardware malfunction 	Do a check of the parameter settings. Examine the actual amount and flow of cooling air. Do a check of the ambient temperature. Examine the heatsink for dust. Make sure that the switching frequency is not too high in relation to the ambient temperature and the motor load. Do a check of the cooling fan. Make an identification run.
44	431	Device changed (different type)	There is a new power unit of a different type. Parameters are not available in the settings.	Reset the fault. The drive reboots after you reset the fault. Set the power unit parameters again.
	433	Device changed (different type)	The option board in slot C was replaced by a new one that you have not used before in the same slot. No parameter settings are saved.	Reset the fault. Set the option board parameters again.
	434	Device changed (different type)	The same cause as in ID433, but refers to Slot D.	
	435	Device changed (different type)	The same cause as in ID433, but refers to Slot D.	
45	441	Device added (different type)	There is a new power unit of a different type. Parameters are not available in the settings.	Reset the fault. The drive reboots after you reset the fault. Set the power unit parameters again.
	443	Device added (different type)	A new option board, that you have not used before in the same slot, was put in slot C. No parameter settings are saved.	Set the option board parameters again.
	444	Device added (different type)	The same cause as in ID443, but refers to Slot D.	
	445	Device added (different type)	The same cause as in ID443, but refers to Slot E.	
46	662	Real Time Clock	The voltage of the RTC battery is low.	Replace the battery.

Fault code	Fault ID	Fault name	Possible cause	How to correct the fault
47	663	Software updated	The software of the drive was updated, the full software package or an application.	No steps are necessary.
50	1050	AI low fault	1 or more of the available analogue input signals is below 50% of the minimum signal range. A control cable is defective or loose. A malfunction in a signal source.	Replace the defective parts. Do a check of the analogue input circuit. Make sure that parameter AI1 Signal Range is set correctly.
51	1051	Device external fault	The digital input signal that is set with parameter P3.5.1.11 or P3.5.1.12 was activated.	This is a user-defined fault. Do a check of the digital inputs and schematics.
52	1052	Keypad communication fault	The connection between the control panel and the drive is defective.	Do a check of the control panel connection and the control panel cable if you have it.
	1352			
53	1053	Fieldbus communication fault	The data connection between the fieldbus master and the fieldbus board is defective.	Do a check of the installation and fieldbus master.
54	1354	Slot A fault	A defective option board or slot	Do a check of the board and the slot. Ask instructions from your nearest distributor.
	1454	Slot B fault		
	1554	Slot C fault		
	1654	Slot D fault		
	1754	Slot E fault		
57	1057	Identification	There was a failure in the identification run.	Make sure that the motor is connected to the drive. Make sure that there is no load on the motor shaft. Make sure that the start command is not removed before the identification run is complete.
58	1058	Mechanical brake	The actual status of the mechanical brake is different from the control signal for longer than the value of P3.20.6.	Do a check of the status and connections of the mechanical brake. See parameter P3.5.1.44 and parameter Group 3.20: Mechanical brake.
63	1063	Quick Stop fault	The Quick stop function is activated	Find the cause for the quick stop activation. After you find it, correct it. Reset the fault and restart the drive. See parameter P3.5.1.26 and the quick stop parameters.
	1363	Quick Stop alarm		

Fault code	Fault ID	Fault name	Possible cause	How to correct the fault
65	1065	PC communication fault	The data connection between the PC and the drive is defective	Do a check of the installation, cable and terminals between the PC and the drive.
66	1366	Thermistor input 1 fault	The motor temperature increased.	Do a check of the motor cooling and the load. Do a check of the thermistor connection. If the thermistor input is not used, you have to short-circuit it. Ask instructions from your nearest distributor.
	1466	Thermistor input 2 fault		
	1566	Thermistor input 3 fault		
68	1301	Maintenance counter 1 alarm	The value of the maintenance counter is higher than the alarm limit.	Do the necessary maintenance. Reset the counter. See parameter B3.16.4 or P3.5.1.40.
	1302	Maintenance counter 1 fault	The value of the maintenance counter is higher than the fault limit.	
	1303	Maintenance counter 2 alarm	The value of the maintenance counter is higher than the alarm limit.	
	1304	Maintenance counter 2 fault	The value of the maintenance counter is higher than the fault limit.	
69	1310	Fieldbus communication fault	The ID number that is used to map the values to Fieldbus Process Data Out is not valid.	Do a check of the parameters in the Fieldbus Data Mapping menu.
	1311		It is not possible to convert 1 or more values for Fieldbus Process Data Out.	The type of the value is undefined. Do a check of the parameters in the Fieldbus Data Mapping menu.
	1312		There is an overflow when the values for Fieldbus Process Data Out (16-bit) are mapped and converted.	Do a check of the parameters in the Fieldbus Data Mapping menu.
76	1076	Start prevented	The start command is blocked to prevent the accidental rotation of the motor during the first power-up.	Reset the drive to start the correct operation. The parameter settings tell if it is necessary to restart the drive.
77	1077	>5 connections	There are more than 5 active fieldbus or PC tool connections. You can use only 5 connections at the same time.	Leave 5 active connections. Remove the other connections.

Fault code	Fault ID	Fault name	Possible cause	How to correct the fault
100	1100	Soft fill timeout	There is a timeout in the Soft fill function in the PID controller. The process value was not achieved in the time limit. A pipe that broke can be the cause.	Do a check of the process. Do a check of the parameters in the menu M3.13.8.
101	1101	Feedback supervision fault (PID1)	The PID controller: the feedback value is not in the supervision limits (P3.13.6.2 and P3.13.6.3) and the delay (P3.13.6.4), if you set the delay.	Do a check of the process. Do a check of the parameter settings, the supervision limits and the delay.
105	1105	Feedback supervision fault (ExtPID)	The external PID controller: the feedback value is not in the supervision limits (P3.14.4.2 and P3.14.4.3) and the delay (P3.14.4.4), if you set the delay.	
109	1109	Input pressure supervision	The supervision signal of the input pressure (P3.13.9.2) is lower than the alarm limit (P3.13.9.7).	Do a check of the process. Do a check of the parameters in menu M3.13.9. Do a check of the input pressure sensor and connections.
	1409		The supervision signal of the input pressure (P3.13.9.2) is lower than the fault limit (P3.13.9.8) .	
111	1315	Temperature fault 1	1 or more of the temperature input signals (set in P3.9.6.1) is higher than the alarm limit (P3.9.6.2).	Find the cause of the temperature rise. Do a check of the temperature sensor and connections. If no sensor is connected, make sure that the temperature input is hardwired. See the option board manual for more data.
	1316		1 or more of the temperature input signals (set in P3.9.6.1) is higher than the fault limit (P3.9.6.3).	
112	1317	Temperature fault 2	1 or more of the temperature input signals (set in P3.9.6.5) is higher than the fault limit (P3.9.6.6).	
	1318		1 or more of the temperature input signals (set in P3.9.6.5) is higher than the fault limit (P3.9.6.7).	

Fault code	Fault ID	Fault name	Possible cause	How to correct the fault
300	700	Unsupported	The application is not compatible (it is unsupported).	Replace the application.
	701		The option board or the slot is not compatible (it is unsupported).	Remove the option board.

11 APPENDIX 1

11.1 THE DEFAULT VALUES OF PARAMETERS IN THE DIFFERENT APPLICATIONS

The explanation of symbols in the table

- A = Standard application
- B = Local/ Remote application
- C = Multi-step speed application
- D = PID control application
- E = Multi-purpose application
- F = Motor potentiometer application

Table 122: The default values of parameters in the different applications

Index	Parameter	Default						Unit	ID	Description
		A	B	C	D	E	F			
3.2.1	Rem Control Place	0	0	0	0	0	0		172	0 = I/O Control
3.2.2	Local/Remote	0	0	0	0	0	0		211	0 = Remote
3.2.6	I/O A Logic	2	2	2	2	2	2		300	2 = Forw-Back (edge)
3.2.7	I/O B Logic	2	2	2	2	2	2		363	2 = Forw-Back (edge)
3.3.1.5	I/O A Ref Sel	6	5	6	7	6	8		117	5 = AI2 6 = AI1 + AI2 7 = PID 8 = Motor Potentiometer
3.3.1.6	I/O B Ref Sel	4	4	4	4	4	4		131	4 = AI1
3.3.1.7	Keypad Ref Sel	2	2	2	2	2	2		121	2 = Keypad Reference
3.3.1.10	Fieldbus Ref Sel	3	3	3	3	3	3		122	3 = Fieldbus Reference
3.3.2.1	Torque Ref Sel	0	0	0	0	4	0		641	0 = Not Used 4 = AI2
3.3.3.1	Preset Freq Mode	-	-	0	0	0	0		182	0 = Binary Coded
3.3.3.3	Preset Freq 1	-	-	10.0	10.0	5.0	10.0		105	
3.3.3.4	Preset Freq 2	-	-	15.0	-	-	-	Hz	106	
3.3.3.5	Preset Freq 3	-	-	20.0	-	-	-	Hz	126	
3.3.3.6	Preset Freq 4	-	-	25.0	-	-	-	Hz	127	
3.3.3.7	Preset Freq 5	-	-	30.0	-	-	-	Hz	128	
3.3.3.8	Preset Freq 6	-	-	40.0	-	-	-	Hz	129	
3.3.3.9	Preset Freq 7	-	-	50.0	-	-	-	Hz	130	
3.5.1.1	Ctrl Signal 1 A	100	100	100	100	100	100		403	100 = DigIN SlotA.1

Table 122: The default values of parameters in the different applications

Index	Parameter	Default						Unit	ID	Description
		A	B	C	D	E	F			
3.5.1.2	Ctrl Signal 2 A	101	101	101	0	101	101		404	0 = DigIN Slot0.1 101 = DigIN SlotA.2
3.5.1.4	Ctrl Signal 1 B	0	103	0	103	0	0		423	0 = DigIN Slot0.1 103 = DigIN SlotA.4
3.5.1.5	Ctrl Signal 2 B	-	104	-	-	-	-		424	104 = DigIN SlotA.5
3.5.1.7	I/O B Ctrl Force	0	105	0	105	0	0		425	0 = DigIN Slot0.1 105 = DigIN SlotA.6
3.5.1.8	I/O B Ref Force	0	105	0	105	0	0		343	0 = DigIN Slot0.1 105 = DigIN SlotA.6
3.5.1.9	Fieldbus Ctrl Force	0	0	0	0	0	0		411	0 = DigIN Slot0.1
3.5.1.10	Keypad Ctrl Force	0	0	0	0	0	0		410	0 = DigIN Slot0.1
3.5.1.11	External Fault Close	102	102	102	101	104	102		405	101 = DigIN SlotA.2 102 = DigIN SlotA.3 104 = DigIN SlotA.5
3.5.1.13	Fault Reset Close	105	0	0	102	102	0		414	0 = DigIN Slot0.1 102 = DigIN SlotA.3 105 = DigIN SlotA.6
3.5.1.19	Ramp 2 Selection	0	0	0	0	105	0		408	0 = DigIN Slot0.1 105 = DigIN SlotA.6
3.5.1.21	Preset Freq Sel0	103	0	103	104	103	103		419	0 = DigIN Slot0.1 103 = DigIN SlotA.4 104 = DigIN SlotA.5
3.5.1.22	Preset Freq Sel1	104	0	104	0	0	0		420	0 = DigIN Slot0.1 104 = DigIN SlotA.5

Table 122: The default values of parameters in the different applications

Index	Parameter	Default						Unit	ID	Description
		A	B	C	D	E	F			
3.5.1.23	Preset Freq Sel2	0	0	105	0	0	0		421	0 = DigIN Slot0.1 105 = DigIN SlotA.6
3.5.1.24	MotPot UP	0	0	0	0	0	104		418	0 = DigIN Slot0.1 104 = DigIN SlotA.5
3.5.1.25	MotPot DOWN	0	0	0	0	0	105		417	0 = DigIN Slot0.1 105 = DigIN SlotA.6
3.5.2.1.1	AI1 Signal Selection	100	100	100	100	100	100		377	100 = AnIN SlotA.1
3.5.2.1.2	AI1 Filter Time	0.1	0.1	0.1	0.1	0.1	0.1	s	378	
3.5.2.1.3	AI1 Signal Range	0	0	0	0	0	0		379	0 = 0..10V / 0..20mA
3.5.2.1.4	AI1 Custom Min	0.0	0.0	0.0	0.0	0.0	0.0	%	380	
3.5.2.1.5	AI1 Custom Max	100.0	100.0	100.0	100.0	100.0	100.0	%	381	
3.5.2.1.6	AI1 Signal Inversion	0	0	0	0	0	0		387	0 = Normal
3.5.2.2.1	AI2 Signal Selection	101	101	101	101	101	101		388	101 = AnIN SlotA.2
3.5.2.2.2	AI2 Filter Time	0.1	0.1	0.1	0.1	0.1	0.1	s	389	
3.5.2.2.3	AI2 Signal Range	1	1	1	1	1	1		390	1 = 2..10V / 4..20mA
3.5.2.2.4	AI2 Custom Min	0.0	0.0	0.0	0.0	0.0	0.0	%	391	
3.5.2.2.5	AI2 Custom Max	100.0	100.0	100.0	100.0	100.0	100.0	%	392	
3.5.2.2.6	AI2 Signal Inversion	0	0	0	0	0	0		398	0 = Normal
3.5.3.2.1	RO1 Function	2	2	2	2	2	2		11001	2 = Run
3.5.3.2.4	RO2 Function	3	3	3	3	3	3		11004	3 = Fault
3.5.3.2.7	RO3 Function	1	1	1	1	1	1		11007	1 = Ready

Table 122: The default values of parameters in the different applications

Index	Parameter	Default						Unit	ID	Description
		A	B	C	D	E	F			
3.5.4.1.1	A01 Function	2	2	2	2	2	2		10050	2 = Output Freq
3.5.4.1.2	A01 Filter Time	1.0	1.0	1.0	1.0	1.0	1.0	s	10051	
3.5.4.1.3	A01 Min Signal	0	0	0	0	0	0		10052	
3.5.4.1.4	A01 Min Scale	0.0	0.0	0.0	0.0	0.0	0.0		10053	
3.5.1.1.5	A01 Max Scale	0.0	0.0	0.0	0.0	0.0	0.0		10054	
3.13.2.6	SP1 Source	-	-	-	3	-	-		332	3 = AI1
3.13.3.1	Function	-	-	-	1	-	-		333	1 = Source 1
3.13.3.3	FB 1 Source	-	-	-	2	-	-		334	2 = AI2

VACON[®]

DRIVEN BY DRIVES

Find your nearest Vacon office
on the Internet at:

www.vacon.com

Manual authoring:
documentation@vacon.com

Vacon Plc.
Runsorintie 7
65380 Vaasa
Finland

Subject to change without prior notice
© 2014 Vacon Plc.

Document ID:



Rev. F